

Personal Protection Equipment from ESAB



A full line of personal protection equipment 2015 catalogue.



World

Since 1904, ESAB has been both a pioneer and leader in welding and cutting development technology. Today ESAB combines world leadership with global applications expertise.



leader

in welding and cutting technology and systems

With over 100 years of experience, and a presence in over 80 countries worldwide, ESAB is probably the most recognised brand in welding and cutting with a product portfolio, which includes:

Standard Welding and Cutting Equipment

Automatic Equipment

Automated Cutting Equipment

Welding Consumables

Personal Protection Equipment (PPE)

Welding Accessories

By continuously improving and developing our products and manufacturing processes, we meet the challenges of technological advance in every sector and market we operate in. Delivering quality products and services remains at the heart of everything we do across all our global sales and product operations.



XA00173620

Contents

Personal Protection Equipment

Helmets, Masks and Screens	6-39
Filter & Spatter Lenses	41
Accessories Welding Helmets	42-43
Hard Hats & Hearing Protection	44-46
Respiratory Equipment	48-61
Spectacles, Goggles & Visors	62-66
Welding Clothing and Coveralls	68-74
Head Protection	75
Welding Gloves	76-82
Safety Footwear	84
Fume Extraction Units	85

Clarification:

Pack: Indicates pack size. If not indicated, pack = 1 x.

Box: Quantity in box



Personal Protection

ESAB offer a comprehensive range of Personal Protection Equipment, covering everything from head to foot, for both welding and cutting and general engineering applications. All ESAB products conform to all relevant EU legislation and standards.

As Health and Safety Standards improve year on year, so does ESAB's commitment to providing a product portfolio capable of meeting the ever increasing demands of the markets we serve. As you would expect from a leading supplier of welding and cutting solutions, the ESAB product range is second to none for quality and reliability.

Helmets, Masks & Screens

Aristo[®] Tech HD – See the weld in HD!

The Aristo[®] Tech HD stands for “High Definition” – with its new matt black shell, newly developed X-Tig feature & optical class 1/1/1/1 represents the “best in class” performance from an auto darkening filter cartridge (ADF).

The newly developed X-Tig feature enhances the ADF’s ability to react in low amp applications and almost eliminates sunlight interference and obstructed sensor occurrences.

Lens Technology

- Variable 5-13 Digital control for adjustment of shade level, sensitivity and delay
- Optical Class 1/1/1/1
100 x 60mm viewing area
- Grind mode activated at lowest sensitivity
- New “X-TIG” mode – Low amp welding function

Comfort Head Gear

- Ergonomic design head gear
- Instant longitudinal adjustment

Shell

- New matte/carbon black finish
- Conforms to:
CE, ANSI, AS/NZS, CSA
- EN175-B Impact Shell
- Weight (total helmet) 515g



1/1/1/1



“X-TIG” Functionality.
Exceptional performance
during low amp welding.



Helmet weighs only 515g



Designed for use with a wide range of welding applications.

Helmets, Masks & Screens



Aristo® Tech HD



Aristo® Tech HD 5-13

Aristo® Tech HD 5-13 is an active welding helmet for professional MIG/MAG, TIG and MMA welding from low to high current values incl. plasma cutting and grinding. Advanced settings such as grinding mode (DIN 4), delay and sensitivity. Quick Set™ facilitates adjustment of shade level and sensitivity. Just push the button during ongoing welding to increase/decrease the set value. For greater clarity, the set value is displayed on the cassette's digital display. High optical class 1/1/1/1. Weight 515g.

Aristo® Tech HD 5-13

0700 000 450

New "X-TIG" Mode

The newly developed "X-TIG" Functionality gives exceptional performance during low amp welding. Alongside it's two sensors, the Aristo HD has the "X-TIG" electromagnetic arc sensor.

Electromagnetic Arc Sensing eliminates: Sunlight interference – outdoors, low-amperage lens opening – TIG, lens openings – pipe/curves, obstructed sensors – hidden/cavity welds



Easy view internal LCD screen showing currently set ADF settings – "X-TIG" function, shade level and delay setting.

Specifications/Technical Data

Cartridge dimensions	90 x 110 x 7mm
Viewing area	100 x 60mm (viewing area)
Power supply	Solar cells only LCD display model with no battery changes
Sensors	2x traditional Arc sensors & 1x internal magnetic sensor – Helps eliminate: sunlight interference – outdoors, low-amperage lens opening – TIG, lens openings – pipe/curves, obstructed sensors – hidden/cavity welds
Classification	1/1/1/1
Protection for ADF	Reflection free front cover lens + inside cover lens
Application ranges	All electric arc welding processes – electrode welding (stick welding, SMAW) / MIG / MAG (GMAW) / GMAW high melting rate process / flux cored wire welding / TIG > 5 amps welding (GTAW) / plasma arc welding
Standards	CE, DIN, ANSI, CSA, AS/NZS

Helmets, Masks & Screens

Aristo® Tech HD – Combinations



Aristo® Tech HD Helmets Prepared for Fresh Air

The Aristo® Tech HD helmet can be used in combination with the Aristo® Air & Eco Air PAPR unit. The helmets are delivered fully assembled, incl. flame resistant head and face seal and air duct.

Aristo® Tech HD prepared for fresh air	0700 000 451
Aristo® Air kit including air hose	0700 002 174
Eco Air IQ kit including air hose	0700 002 175

Aristo Air and Eco Air spares can be found on pages 52-53.



Aristo® Tech HD with Hard Hat

By removing the head harness and replacing it with a hard hat adapter the Aristo® Tech HD can be fitted on to ESAB's protective helmet. The combination is very well balanced and comfortable to wear. The Aristo® Tech HD helmet can be detached and reattached in a second. The specially designed hard hat meets the highest standards and it's equipped with ratchet adjustment.

Aristo® Tech HD 5-13	0700 000 450
Helmet adapter Universal Concept	0700 001 005
Hard Hat Concept Yellow	0700 000 052
Hard Hat Concept White	0700 000 135
Hard Hat Concept Blue	0700 000 136
Hard Hat Concept Green	0700 000 137
Hard Hat Concept Red	0700 000 138
Hard Hat Concept Orange	0700 000 142
Sweat band Concept hard hat, pack of 10	0700 000 140
Head harness Concept hard hat, pack of 10	0700 000 141
Hearing protection Universal SNR 29 dB	0700 001 009
Hearing protection Universal with FM-radio SNR 29 dB	0700 001 010



Concept hard hat available in six colours!

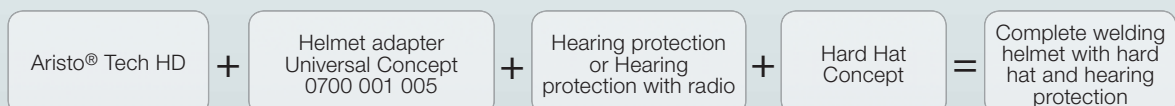

Helmets, Masks & Screens



Aristo® Tech HD – Combinations



Aristo® Tech HD Helmets with Hard Hat Prepared for Fresh Air

Aristo® Tech HD welding helmets can be used in combination with a hard hat (only black available) and Aristo® Air & Eco Air PAPR units. The helmets are delivered fully assembled, incl. hard hat with internal air duct and flame resistant head and face seal.

Aristo® Tech HD with hard hat prepared for fresh air	0700 000 466
--	---------------------

Aristo® Air kit incl. air hose	0700 002 174
Eco Air IQ kit incl. air hose	0700 002 175

Spares for Aristo® Tech HD for hard hat & prepared for fresh air

Head seal Aristo® Tech HD for hard hat & fresh air	0700 002 170
Face seal Aristo® Tech HD for hard hat & fresh air	0700 002 171
Hard hat black Aristo® Tech HD with hard hat & fresh air	0700 002 172

Aristo Air and Eco Air spares can be found on pages 52-53.

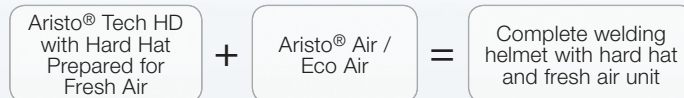

Aristo® Tech HD with Internal Visor

The Aristo® Tech HD with internal visor is delivered with an air fed grade B impact protection grinding visor complete with a face and head seal. The grinding visor can be fitted to the standard Aristo® Tech HD helmet and can be combined with the Aristo® Air & Eco Air PAPR unit. This would be the ideal system for all applications involved in welding fabrication. One head system for welding and grinding.

Aristo® Tech HD with internal visor	0700 000 467
-------------------------------------	---------------------

Aristo® Air kit incl. air hose	0700 002 174
Eco Air IQ kit incl. air hose	0700 002 175

Spares for Aristo® Tech HD with internal visor and prepared for fresh air

Head and face seal Aristo® Tech HD internal visor	0700 002 167
Visor clear Aristo® Tech HD internal visor	0700 002 169
Protective film Aristo® Tech HD internal visor	0700 002 054

Aristo Air and Eco Air spares can be found on pages 52-53.

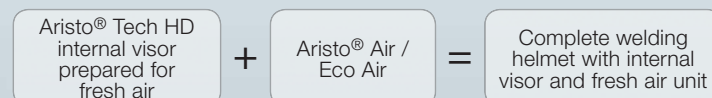



Helmets, Masks & Screens



Aristo® Tech HD – Spares

Spares for Aristo® Tech & Aristo® Tech HD

1	Helmet shell Aristo® Tech HD Carbon Black.....	0700 000 453
*	Headgear Aristo® Tech	0700 000 368
*	Aristo® Tech HD Headgear side bolts.....	0700 000 459
*	Aristo® Tech HD Headgear.....	0700 000 454
*	Sweat band Aristo® Tech & Aristo® Tech HD, pack of 2	0700 000 369
2	Front cover lens – Aristo® Tech HD/Eye-Tech, Warrior Tech™ pack of 10	0700 000 010
2	Front cover lens Hard Coated – Aristo® Tech HD/Eye-Tech, Warrior Tech™ pack of 10.....	0700 000 370
3	Inside cover lens Aristo® Tech, pack of 5.....	0700 000 371
3	Inside Cover Lens Aristo Tech HD – 103 x 60mm	0700 000 455
4	Cartridge 5-13 assembly	0700 000 372
4	Cartridge 5-13 Aristo® Tech HD assembly	0700 000 456
5	Potentiometer Aristo® Tech & Aristo® Tech HD	0700 000 373
6	Magnifying lens +1,0 dioptré	0700 000 084
6	Magnifying lens +1,5 dioptré	0700 000 085
6	Magnifying lens +2,0 dioptré	0700 000 086
6	Magnifying lens +2,5 dioptré	0700 000 087
*	Leather chest protector for welding helmet	0700 000 062
*	Leather head and chest protector for welding helmet	0700 000 063

* Not shown. For accessories such as magnifying glass, hard hats etc., see page 42-46.

Spares for Aristo® Tech HD 5-13 Prepared for Fresh Air

7	Air duct including screws	0700 002 002
8	Screw for air duct, 2x/pack.....	0700 002 028
9	Head and face seal Aristo® Tech.....	0700 002 160
10	Air hose standard (850mm).....	0468 127 011
10	Air hose long (1000mm)	0700 002 055
10	Air hose Heavy-duty (850mm)	0700 002 081
11	Hose cover (for air hose)	0349 501 071
12	Holder air duct	0700 002 029

For face seals and visors for Aristo® HD hard hat & internal visor variations, see page 9.

Spares for Aristo® Air and Eco Air, see page 52-53.

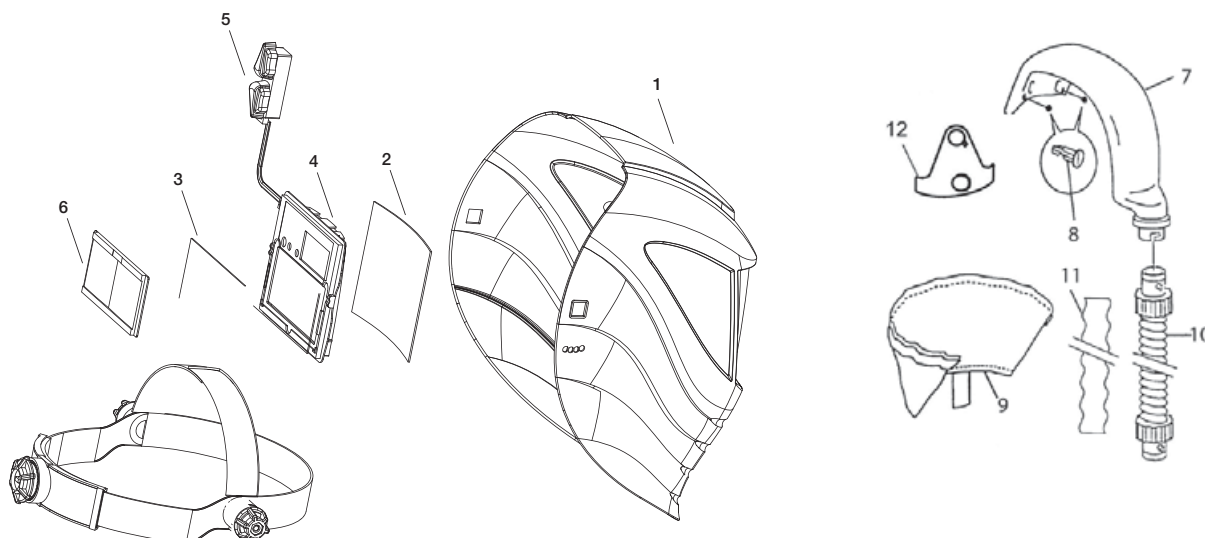

Helmets, Masks & Screens

New-Tech™ ADC Plus

The ADC plus is the second phase technology from the original New-Tech™ ADC range of welding helmets from ESAB, a market-leading supplier of welding related personal protection equipment. As a result of extensive research into typical application and user comfort requirements, the ESAB New-Tech™ ADC Plus cartridge offers new features, which make these new helmets unique.

The new 'Angular Dependence Compensation' Plus (ADC) ensures that the selected shade covers the full width and height of the LCD screen, whilst the addition of the Plus offers improved colour definition and contrast throughout the cartridge.

- Increased colour definition
 - Lighter contrast
 - External adjustable shade
 - External adjustable sensitivity
 - External delay adjustment
 - Superb optical quality
- 1/1/1/1 EN379



Optical class 1, 2 or 3 – indicates optical quality of the ocular. Class 1 is the best.

Light diffusion class – (switchable filters only) 1, 2 or 3 – indicates light diffusion by the ocular. Class 1 is the best.



Variations in luminous transmittance – (switchable filters only) 1, 2 or 3 – indicates shade variability in the dark state of the ocular. Class 1 is the best.

Angle dependence of luminous transmittance class (optional) – If applicable, marked before the standard number. Classes 1, 2 or 3 with class 1 is the best.

There are 3 helmets in the New-Tech™ ADC Plus range all offering superb performance and the ultimate in operator protection and comfort.

New-Tech™ 9-13 ADC Plus

New-Tech™ 6-13 ADC Plus

New-Tech™ 6-13 XL ADC Plus



Helmets, Masks & Screens

New-Tech™ ADC Plus Difference

XL VIEWING AREA

New-Tech™ 6-13 XL ADC Plus helmet offers an increased cartridge viewing area of 96 x 68.5mm.

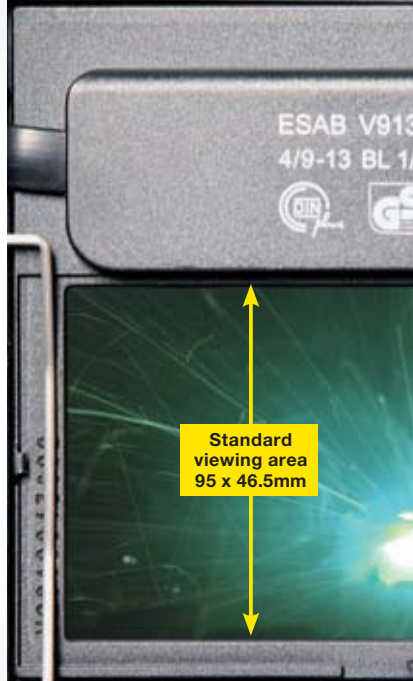

STANDARD ADC PLUS SIZE

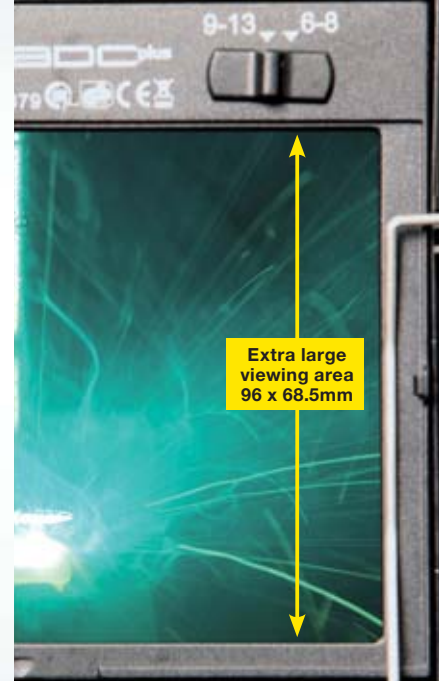

XL ADC PLUS SIZE

OPEN STATE

ADC Plus Colour Definition

The ADC Plus range offers superior colour definition in both the open and activated state, allowing the welder to better see the LED displays on machines and equipment, whilst also identifying heat definition on the actual weld.

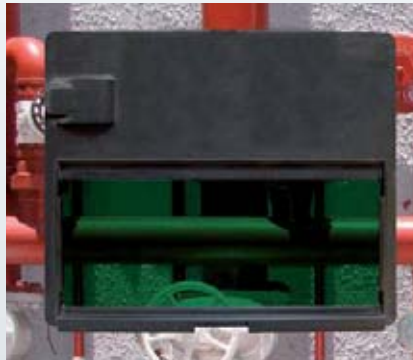

STANDARD NON ADC PLUS CARTRIDGE

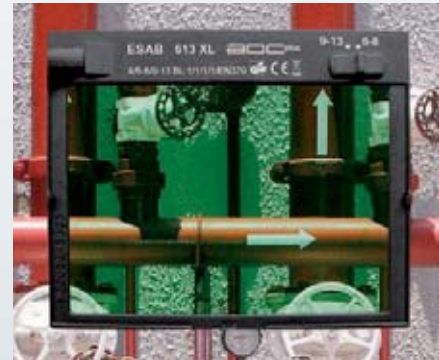

ADC PLUS CARTRIDGE

CLOSED STATE

ADC Plus Optical Quality

The ADC Plus cartridge boasts a 1/1/1 optical quality rating, which is the best on the market. This means that an even shade level is seen across the full height and width of the viewing area.

The benefits – an increased shaded area that covers the height and width of the cartridge, whilst reducing bright visible light.



STANDARD NON ADC PLUS CARTRIDGE



ADC PLUS CARTRIDGE

Helmets, Masks & Screens

New-Tech™ ADC Plus



New-Tech™ 6-13 ADC XL ADC Plus

The New-Tech™ 6-13 XL can be used for almost any application. The shade level can be adjusted from DIN 6 to DIN 13, making this helmet very versatile. All settings are made from the outside of the helmet. The helmet features a grinding mode, where the cartridge can be switched off for grinding, there is also a sensitivity and delay function. The New-Tech™ 6-13 XL is equipped with ADC technology which will ensure a solid shade level even when viewing the lens at an angle, i.e. positional welding. Conforms to EN 175 and EN 379.

New-Tech™ 6-13 XL ADC Plus

0700 000 955



New-Tech™ 6-13 ADC Plus

The New-Tech™ 6-13 can be used for almost any application. The shade level can be adjusted from DIN 6 to DIN 13, making this helmet very versatile. All settings are made from the outside of the helmet. The helmet features a grinding mode, where the cartridge can be switched off for grinding, there is also a sensitivity and delay function. The New-Tech™ 6-13 is equipped with ADC technology which will ensure a solid shade level even when viewing the lens at an angle, i.e. positional welding. Conforms to EN 175 and EN 379.

New-Tech™ 6-13 ADC Plus

0700 000 956



New-Tech™ 9-13 ADC Plus

The New-Tech™ 9-13 ADC offers the latest ADC-technology which will ensure a solid shade level even when viewing the lens at an angle, i.e. positional welding. The settings, such as shade level DIN 9 to 13, sensitivity and delay, are made from the outside of the helmet. The New-Tech™ 9-13 is suitable for almost all applications, TIG, MIG/MAG, MMA and gas welding/cutting. Conforms to EN 175 and EN 379.

New-Tech™ 9-13 ADC Plus

0700 000 957



Helmets, Masks & Screens

New-Tech™ ADC Plus Combinations



New-Tech™ Prepared for Fresh Air

All New-Tech™ welding helmets can be used in combination with, Air 160 and compressed air units. The helmets are delivered fully assembled, incl. flame resistant head and face seal and air duct. Follow three simple steps to make up your combination: **1.** Select the New-Tech™ helmet package that you require. **2.** Select the hose kit you require. **3.** Select the air unit your require.

New-Tech™ 6-13 XL ADC Plus prepared for fresh air	0700 000 966
New-Tech™ 6-13 ADC Plus prepared for fresh air	0700 000 960
New-Tech™ 9-13 ADC Plus prepared for fresh air	0700 000 963
ESAB Air 160-8H w/intelligent charger	0700 002 879

Spares for Air 160, see page 54.



Concept hard hat available in six colours!

New-Tech™ with Hard Hat

By removing the head harness and replacing it with a hard hat adapter (0700 001 005) the New-Tech™ can be fitted on to ESAB's protective helmet. The combination is very well balanced and comfortable to wear. The New-Tech™ helmet can be detached and reattached in a second. The specially designed hard hat meets the highest standards and it's equipped with ratchet adjustment. **1.** Select the New-Tech™ helmet. **2.** Select the hard hat adapter. **3.** Select the hard hat.

New-Tech™ 6-13 XL ADC Plus	0700 000 955
New-Tech™ 6-13 ADC Plus	0700 000 956
New-Tech™ 9-13 ADC Plus	0700 000 957
Helmet adapter Universal Concept	0700 001 005
Hard Hat Concept Yellow	0700 000 052
Hard Hat Concept White	0700 000 135
Hard Hat Concept Blue	0700 000 136
Hard Hat Concept Green	0700 000 137
Hard Hat Concept Red	0700 000 138
Hard Hat Concept Orange	0700 000 142
Sweat band Concept hard hat, pack of 10	0700 000 140
Head harness Concept hard hat, pack of 10	0700 000 141
Hearing protection Universal SNR 29 dB	0700 001 009
Hearing protection Universal with FM-radio SNR 29 dB	0700 001 010

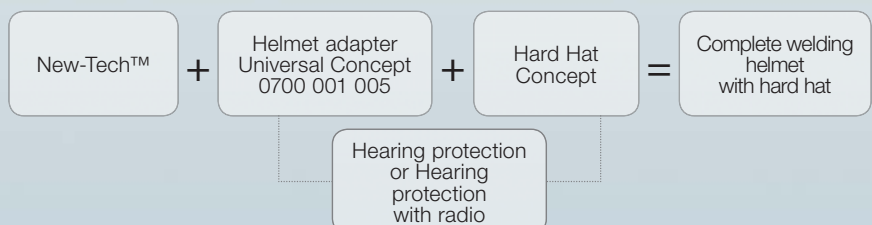

Helmets, Masks & Screens

New-Tech™ ADC Plus Combinations



New-Tech™ Helmets with Hard Hat & Fresh Air

All New-Tech™ welding helmets can be used in combination with a hard hat, Air 160, Air 200 and compressed air units. The helmets are delivered fully assembled, incl. hard hat with internal air duct and flame resistant head and face seal. Follow three simple steps to make up your combination: **1.** Select the New-Tech™ helmet package that you require. **2.** Select the hose kit you require. **3.** Select the air unit your require.

New-Tech™ 6-13 XL ADC Plus prep for Fresh air & hard hat	0700 000 958
New-Tech™ 9-13 ADC Plus prep for Fresh air & hard hat	0700 000 961
New-Tech™ 9-13 ADC Plus prep for Fresh air & hard hat	0700 000 964
ESAB Air 160-8H w/intelligent charger	0700 002 879

Spares for New-Tech™ with hard hat & prepared for fresh air

Head seal New-Tech™ with hard hat & fresh air	0700 000 093
Face seal New-Tech™ with hard hat & fresh air	0700 000 094
Hard hat black New-Tech™ with hard hat & fresh air	0700 000 097

Spares for Air 160, see page 54.



New-Tech™ with Internal Visor Prepared for Fresh Air

All New-Tech™ helmets available in a version with internal clear visor, which is CE approved for grinding (impact resistance class B). When the welding helmet is folded up the welder has an unobstructed field of view through the visor. The combination is also prepared for fresh air with fresh air units or compressed air Air CA. The New-Tech™ helmet is supplied complete with installed internal visor and with flame-proof head and face seal as well as air duct. Air hose and fresh air unit purchased separately.

New-Tech™ 6-13 XL ADC Plus int. visor & prep for fresh air	0700 000 959
New-Tech™ 6-13 ADC Plus int. visor & prep for fresh air	0700 000 962
New-Tech™ 9-13 ADC Plus int. visor & prep for fresh air	0700 000 965
ESAB Air 160-8H w/intelligent charger	0700 002 879

Spares for New-Tech™ with internal visor & prepared for fresh air

Head seal New-Tech™ internal visor	0700 002 051
Face seal New-Tech™ internal visor	0700 002 052
Visor clear New-Tech™ internal visor	0700 002 053
Protective film New-Tech™ internal visor	0700 002 054

Spares for Air 160, see page 54.

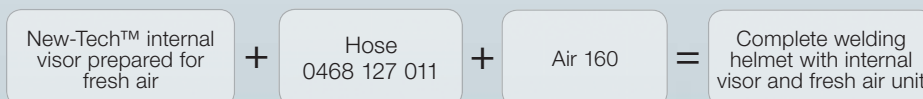

Helmets, Masks & Screens

New-Tech™ ADC Plus – Spares

Spares for New-Tech™

1	Helmet Shell New Tech.....	Not sold separately
2	Cartridge New-Tech™ 6-13 XL ADC Plus	0700 000 270
2	Cartridge New-Tech™ 6-13 ADC Plus	0700 000 272
2	Cartridge New-Tech™ 9-13 ADC Plus	0700 000 273
3	Adjustment knob kit New-Tech™	0700 000 223
4	Front Cover Lens CR39 New-Tech™, pack of 10	0700 000 139
5	Supporting Frame New-Tech™.....	0700 000 220
6	Metal Locking Spring New-Tech™, pack of 2.....	0700 000 221
7	Inside Cover Lens New-Tech™ 6-13/9-13 ADC Plus, pack of 10.....	0700 000 228
7	Inside Cover Lens New-Tech™ 6-13 XL ADC Plus, pack of 10.....	0700 000 268
8	Sweat Band New-Tech™, pack of 2	0700 000 231
9	Headgear Complete New-Tech™	0700 000 222
10	Sweat band neck protection New-Tech™, pack of 2.....	0700 000 232
*	Magnifying lens +1,0 dioptré	0700 000 084
*	Magnifying lens +1,5 dioptré	0700 000 085
*	Magnifying lens +2,0 dioptré	0700 000 086
*	Magnifying lens +2,5 dioptré	0700 000 087
*	Leather chest protector for welding helmet	0700 000 062
*	Leather head and chest protector for welding helmet	0700 000 063

For accessories such as hard hats etc., see page 42-46.

Spares for New-Tech™ Prepared for Fresh Air

11	Head seal New-Tech™	0700 002 048
12	Air duct New-Tech™.....	0700 002 050
13	Screw for air duct, 2x/pack.....	0700 002 028
14	Face seal New-Tech™.....	0700 002 049
15	Air hose standard (850mm).....	0468 127 011
15	Air hose long (1000mm)	0700 002 055
15	Air hose Heavy-duty (850mm).....	0700 002 081
16	Hose cover (for air hose)	0349 501 071
*	Conversion kit New-Tech™ (to convert the helmet to a fresh air helmet).....	0700 002 047

* Not shown

For face seals and visors for New Tech hard hat & internal visor variations, see page 16.

Spares for Air 160/200, see page 54.

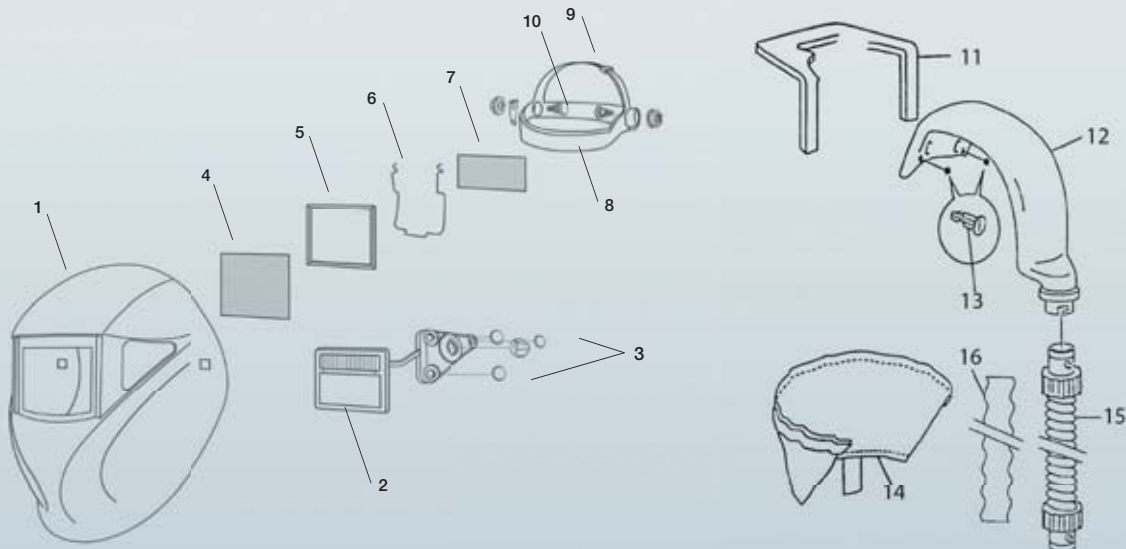

Helmets, Masks & Screens

Warrior™ Tech

The WARRIOR™ Tech helmet has been designed to meet the needs of a variety of welders, providing a high tech lightweight shell to protect from heat, sparks and spatter. The welding lens gives a high clarity of view, resulting in an excellent optical quality utilising the latest ADF technology.

The WARRIOR™ Tech helmet provides ideal functionality, performance and comfort to the occasional welder, maintenance and construction workers through to the professional welder.

- Variable shade level DIN 9-13
- High optical class 1/2/1/2 according to EN 379
- Large field of view 98 x 48mm
- Lightweight – only 520g
- 4 sensors ensure correct read off
- Robust head harness – easy to adjust
- Ergonomic sweat band – increased comfort
- Variable sensitivity with internal knob
- Variable delay with internal knob
- Magnifying glass available as an accessory



Helmet weighs only 520g



ENHANCED PERFORMANCE

- Four Arc sensors for higher response and wider coverage
- Optimal performance for most fabrication and out-of-position welding



SENSITIVITY CONTROL

- An adaptable feature useful when welding low amperages (TIG) for better reaction to darker Arc light



LARGE VIEWING AREA

- 98mm x 48mm (3.85" x 1.88")
- Giving a wider field of vision increasing spatial awareness
- 1/2/1/2 – Optical Class 9–13 shade level

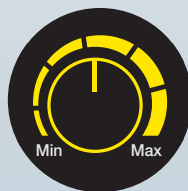

DELAY CONTROL

- Enabling the welder to set how long the lens stays dark after welding arc stops
- Short delay helps get the job done faster during tack welding, whilst longer delay is useful for high amperage welding



Helmets, Masks & Screens

Warrior™ Tech



Available with dioptric configurations as standard

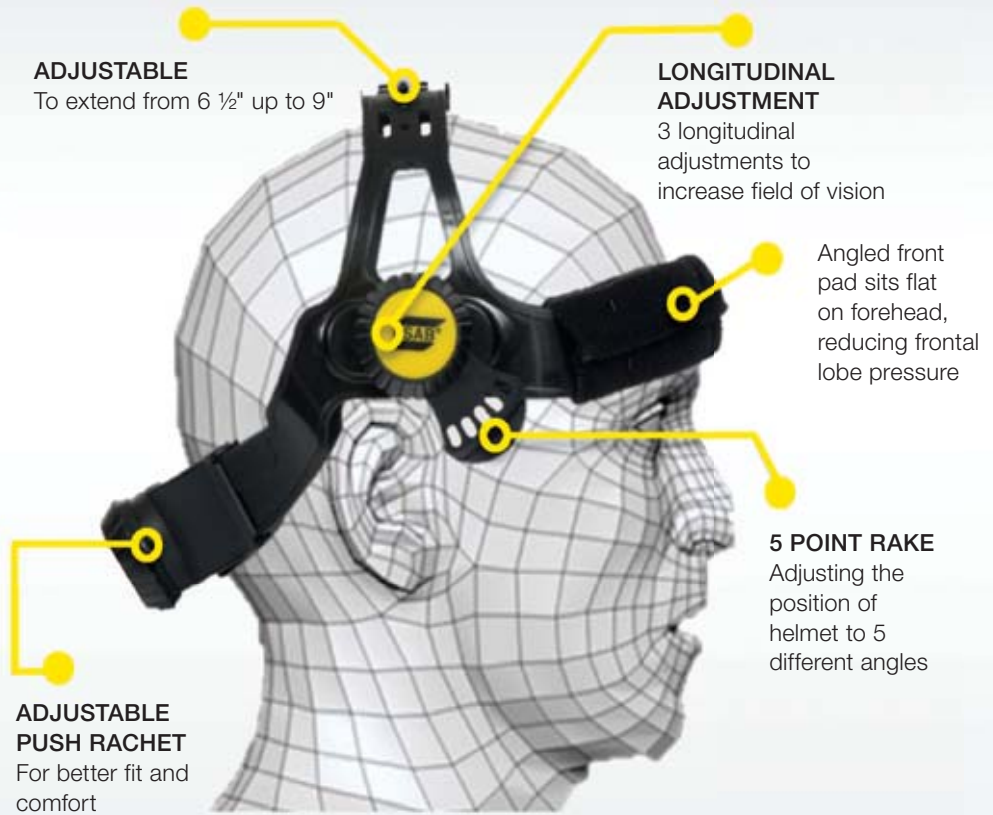

Warrior™ Tech 9-13

Warrior™ Tech 9-13 is an automatically dimming welding helmet for MIG/MAG, MMA and TIG welding (>20 Amp) with infinitely variable shade levels from DIN 9-13. The external adjustment knob makes it easy for the welder to adjust the shade level. Sensitivity and delay can be adjusted according to requirements. The Warrior™ Tech 9-13 helmet is available in two colours; classic black or tough ESAB yellow. Lightweight, only 520g. Built-in battery charged by solar cells. The welding helmet is recommended for MIG/MAG, TIG and MMA welding (>20 Amp). High optical quality 1-2-1-2. CE approved according to both EN 379 and EN 175.

Warrior™ Tech 9-13, black
Warrior™ Tech 9-13, yellow

0700 000 400
0700 000 401

Helmets, Masks & Screens

Warrior™ Tech Combinations



Warrior™ Tech 9-13 Prepared for Fresh Air

All Warrior™ Tech helmets are prepared for fresh air with the fresh air units Aristo® Air and Eco Air. Warrior™ Tech helmets prepared for fresh air supplied fully fitted with flame-proof head and face seal and air duct. Lightweight and the best possible protection for the discerning welder. Fresh air unit purchased separately.

Warrior™ Tech 9-13 black prepared for fresh air	0700 000 405
Warrior™ Tech 9-13 yellow prepared for fresh air	0700 000 406
Eco Air IQ kit incl. air hose	0700 002 175

Spares for Eco Air, see page 53.



Warrior™ Tech 9-13 with Hard Hat

Warrior™ Tech offers the welder the unique possibility of removing the hard hat with one hand movement. This means optimum safety and the best ergonomics for the welder – the helmet is used when required, while the neck is not put under strain unnecessarily. The welding helmet's usual head harness is replaced with the unique helmet adapter (0700 001 005), which secures the hard hat in place. The hard hat is made of ABS and only weighs 300g. Available in six different colours. Supplied with sweat band. CE approved according to EN 397. Helmet mounted hearing protection available as an option.

Warrior™ Tech 9-13 black	0700 000 400
Warrior™ Tech 9-13 yellow	0700 000 401
Helmet adapter Universal Concept	0700 001 005
Hard hat Concept yellow	0700 000 052
Hard hat Concept white	0700 000 135
Hard hat Concept blue	0700 000 136
Hard hat Concept green	0700 000 137
Hard hat Concept red	0700 000 138
Hard hat Concept orange	0700 000 142
Sweat band Concept hard hat, pack of 10	0700 000 140
Head harness Concept hard hat, pack of 10	0700 000 141
Hearing protection Universal SNR 29 dB	0700 001 009
Hearing protection Universal with FM-radio SNR 29 dB	0700 001 010

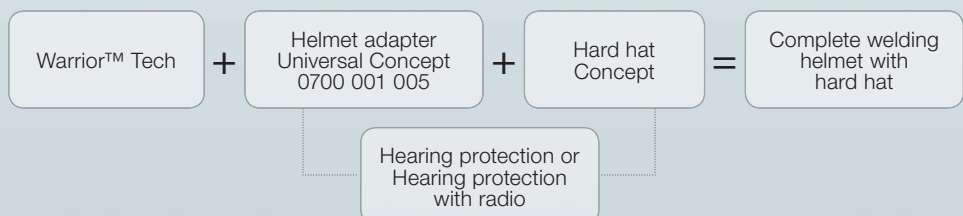



Helmets, Masks & Screens

Warrior™ Tech – Spares

Spares for Warrior™ Tech 9-13

1	Head harness.....	0700 000 415
2	Sweat band, pack of 2.....	0700 000 414
3	Protective glass outside, pack of 10.....	0700 000 010
4	Protective glass inside.....	0700 000 416
5	Mounting frame cassette.....	0700 000 418
6	Cassette holder incl. screws.....	0700 000 419
7	Cassette Warrior™ Tech 9-13.....	Not sold separately
*	Magnifying lens +1,0 dioptré.....	0700 000 084
*	Magnifying lens +1,5 dioptré.....	0700 000 085
*	Magnifying lens +2,0 dioptré.....	0700 000 086
*	Magnifying lens +2,5 dioptré.....	0700 000 087
*	Leather chest protector for welding helmet.....	0700 000 062
*	Leather head and chest protector for welding helmet.....	0700 000 063

* Not shown

For accessories such as magnifying glass, hard hats etc., see page 42-46.

Spares for Warrior™ Tech Prepared for Air

8	Head and face seal Warrior™ Tech.....	0700 000 421
9	Warrior™ Tech head gear including air duct.....	0700 000 420
10	Air hose for Warrior/Eco Air.....	0468 127 011

Spares for Eco Air, see page 53.

Spare parts Warrior™ Tech 9-13 and Warrior™ Tech Prepared for Air

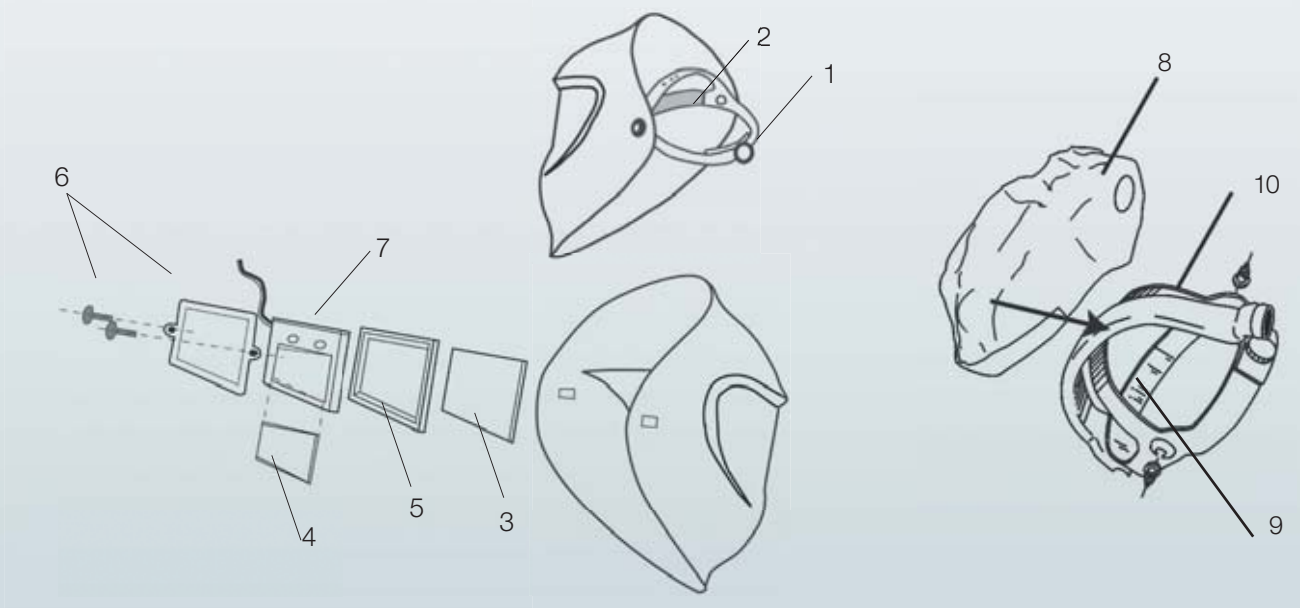

Helmets, Masks & Screens

Origo™ Tech – Spares

Spares for Origo™ Tech 9-13 – Discontinued

1	ESAB Head Gear Pro.....	0700 000 243
2	Sweat Band Head Gear Pro, pack of 2.....	0700 000 244
3	Front Cover Lens Origo™ Tech, pack of 10	0700 000 245
4	Inside Cover Lens Origo™ Tech, pack of 10	0700 000 246
5	ESAB 9-13 ADF Cradle	0700 000 235
6	Lens Retainer with Screws	0700 000 237
7	Cartridge Origo™ Tech 9-13	Not sold separately
*	Magnifying lens +1,0 dioptr	0700 000 084
*	Magnifying lens +1,5 dioptr	0700 000 085
*	Magnifying lens +2,0 dioptr	0700 000 086
*	Magnifying lens +2,5 dioptr	0700 000 087
*	Leather chest protector for welding helmet	0700 000 062
*	Leather head and chest protector for welding helmet	0700 000 063

* Not shown

For accessories such as magnifying glass, hard hats etc., see page 42-46.

Spares for Origo™ Tech Prepared for Fresh Air

8	Sweat band ESAB Pro prepared for fresh air, pack of 2	0700 000 274
9	Head and face seal Origo™ Tech	0700 002 101
10	Air duct incl. head harness ESAB Pro Origo™ Tech	0700 002 102

Spares for Origo Air, see page 55.

Spares for Origo™ Tech 9-13 and Origo™ Tech prepared for Fresh Air

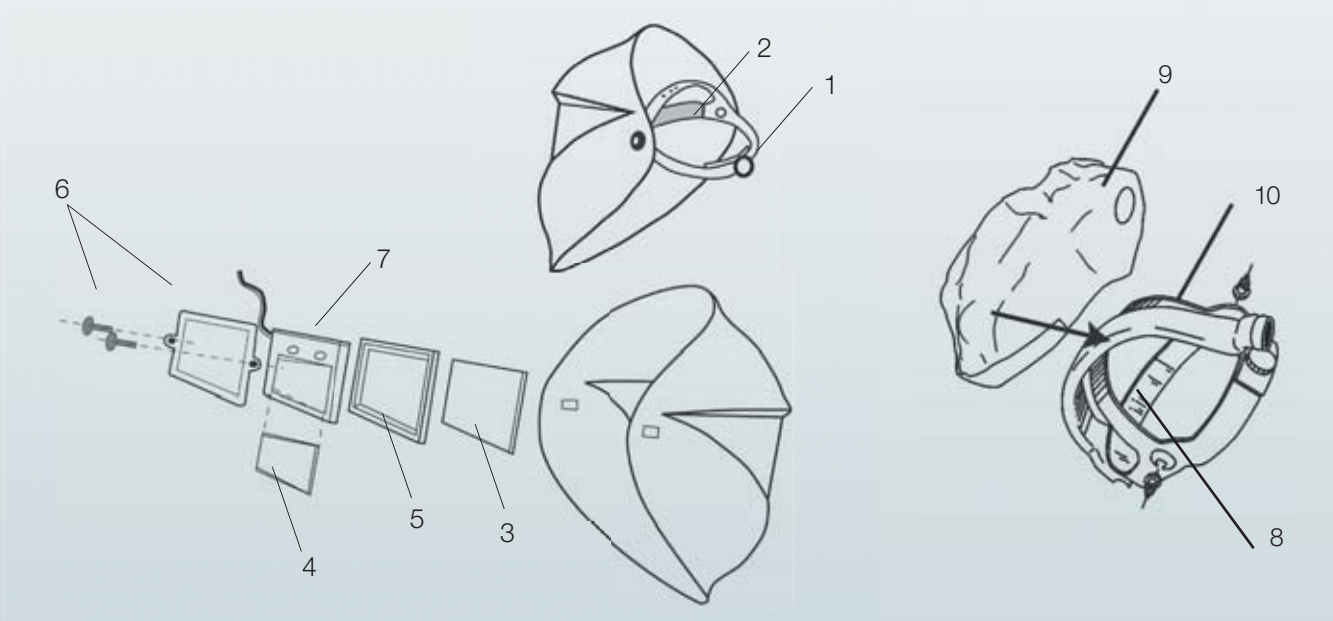

Helmets, Masks & Screens

Albatross Welding Helmets

The Albatross range consists of several types of lightweight welding helmets with flip-up visor. Newly introduced to the range, Albatross 4000X 9-13 also has an automatically dimmed cassette. Albatross welding helmets have maximum flexibility and can be combined with hard hats, hearing protection and fresh air units. The helmet shell is made of extremely lightweight and resistant material, giving a long service life and excellent comfort. The ESAB Pro head harness is very easy to adjust for a perfect fit.



Albatross 4000X 9-13

Albatross 4000X 9-13 is a combined welding and grinding helmet with automatically dimming cassette, shade levels DIN 9-13, and with flip-up visor. The large plastic lens gives the welder an unobstructed field of view when the visor is flipped up. The helmets are rated B in the impact resistance classification, which means they are approved for grinding. Weight 615g. CE approved according to EN 379, EN 175 and EN 166, class B.

Albatross 4000X 9-13 standard

0700 000 319



Albatross 4000X

Albatross 4000X is a combined welding and grinding helmet with flip-up visor. The large plastic lens gives the welder an unobstructed field of view when the visor is flipped up. The helmets are rated B in the impact resistance classification, which means they are approved for grinding. Welding glass DIN 10 and protective glass included at delivery. Weight 580g. CE approved according to EN 175 and EN 166, class B.

Albatross 4000X standard

0700 000 315



Albatross 1000

Albatross 1000 has a flip-up visor for the welding glass, 60 x 110mm or 90 x 110mm. The large clear plastic lens protects the face when the visor is flipped up. Welding glass DIN 10 and protective glass included at delivery. Weight 400g (60 x 110) resp 420g (90 x 110). CE approved according to EN 175.

Albatross 1000 60 x 110 standard

0000 595 200

Albatross 1000 90 x 110 standard

0349 502 204



Helmets, Masks & Screens

Albatross Respiratory Combinations



Albatross Welding Helmets Prepared for Fresh Air

All Albatross helmets are prepared for fresh air with the Eco Air fresh air unit. Albatross helmets prepared for fresh air supplied fully fitted with flame-proof head and face seal and air duct. Lightweight and the best possible protection for the professional welder. Adapter and fresh air unit purchased separately.

Albatross 1000 60 x 110 prepared for fresh air, 610g	0700 000 352
Albatross 1000 90 x 110 prepared for fresh air, 630g	0700 000 351
Albatross 4000X prepared for fresh air, 780g	0700 000 316
Albatross 4000X 9-13 prepared for fresh air, 880g	0700 000 320
Adapter Air air hose	0700 002 176
Eco Air IQ kit incl. air hose	0700 002 175

Spares for Eco Air, see page 53.

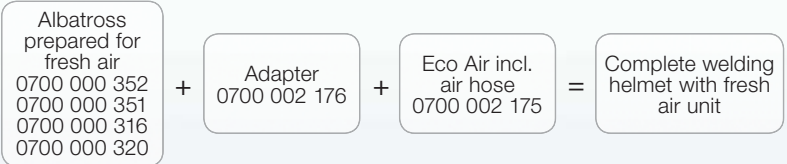

Helmets, Masks & Screens

Albatross Respiratory Combinations

Albatross Welding Helmets Prepared for Hard Hat and Fresh Air



Albatross 4000X helmets are prepared for fixed mounting of Peltor G3000N hard hats together with Eco Air fresh air unit. Fresh air is supplied from both sides of the helmet. Lightweight. The yellow Peltor G3000N hard hats are made of UV stabilised ABS and only weigh 340g.

Albatross 4000X prepared for hard hat& fresh air* 560g	0700 000 318
Albatross 4000X 9-13 prep for hard hat & fresh air* 660g	0700 000 322
Helmet adapter Universal Concept/Peltor G3000N	0700 001 005
Hearing protection SNR 29 dB	0700 001 009
Hearing protection with FM-radio SNR 29 dB	0700 001 010
Hard hat Peltor G3000N	0468 051 881
Hard hat Concept yellow	0700 000 052
Hard hat Concept white	0700 000 135
Hard hat Concept blue	0700 000 136
Hard hat Concept green	0700 000 137
Hard hat Concept red	0700 000 138
Hard hat Concept orange	0700 000 142
Sweat band Concept hard hat, pack of 10	0700 000 140
Head harness Concept hard hat, pack of 10	0700 000 141
Adapter Air air hose	0700 002 176
Eco Air kit incl. air hose	0700 002 175



Concept hard hat available in six colours!

* hard hat ordered separately

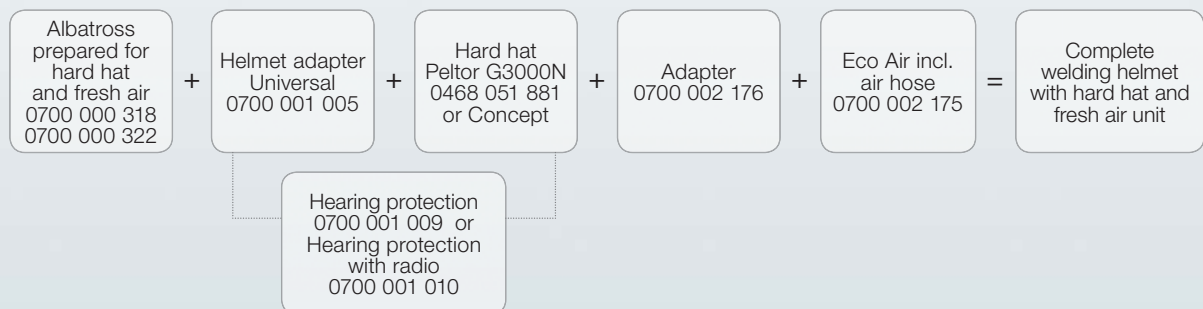



Helmets, Masks & Screens

Albatross Respiratory Combinations

Albatross Welding Helmets Prepared for Hard Hat



All Albatross helmets are prepared for fixed mounting of Concept and Peltor G3000N hard hats. Lightweight.

The yellow Peltor G3000N hard hats are made of UV stabilised ABS and only weigh 340g. Mounting for easy installation of hearing protection. Supplied with sweat band. CE approved according to EN 397.



Concept hard hat available in six colours!

Albatross 1000 60 x 110 prepared for hard hat*	360g	0000 595 205
Albatross 1000 90 x 110 prepared for hard hat*	380g	0349 502 205
Albatross 4000X prepared for hard hat*	500g	0700 000 317
Albatross 4000X 9-13 prepared for hard hat*	600g	0700 000 321
Helmet adapter Universal Concept/Peltor G3000N		0700 001 005
Hard hat Peltor G3000N		0468 051 881
Hard hat Concept yellow		0700 000 052
Hard hat Concept white		0700 000 135
Hard hat Concept blue		0700 000 136
Hard hat Concept green		0700 000 137
Hard hat Concept red		0700 000 138
Hard hat Concept orange		0700 000 142
Sweat band Concept hard hat, pack of 10		0700 000 140
Head harness Concept hard hat, pack of 10		0700 000 141
Hearing protection Universal SNR 29 dB		0700 001 009
Hearing protection Universal with FM-radio SNR 29 dB		0700 001 010

* hard hat ordered separately

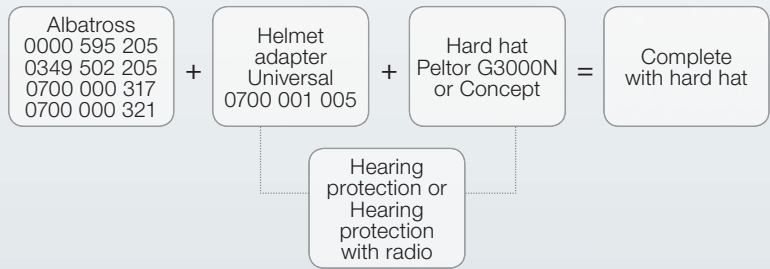

Helmets, Masks & Screens

Albatross Welding Helmets – Spares

Spares for Albatross 1000, 4000X and 4000X 9-13 Standard / Prepared for Hard Hat / Prepared for Fresh Air

1	Flip-up visor 60 x 110	0000 595 152
1	Flip-up visor 90 x 110	0349 501 084
2	Safety glass 60 x 110 plastic transparent, pack of 100.....	0160 307 001
2	Safety glass 90 x 110 plastic transparent, pack of 100.....	0160 307 004
3	Springs 60 x 110, pack of 5.....	0000 595 153
3	Springs 90 x 110, pack of 5.....	0000 595 383
4	Head harness ESAB Pro for use in all Albatross variants	0700 000 243
5	Hose sleeve for air hose Eco Air	0349 501 071
5	Hose sleeve for air hose Origo™ Air	0700 002 104
6	Head and face seal.....	0700 000 951
7	Welding glass 60 x 110, DIN 10, pack of 25	0160 292 002
7	Welding glass 90 x 110 80g, DIN 10, pack of 25	0760 031 632
8	Air duct incl. head harness ESAB Pro for use in all Albatross standard fresh air variants.....	0700 002 102
9	Adapter Eco Air air hose	0700 002 176
10	Sweat band ESAB Pro, pack of 2.....	0700 000 244
11	Sweat band ESAB Pro prepared for fresh air, pack of 2.....	0700 000 274
12	Air hose Origo™ Air (850mm).....	0700 002 103
12	Air hose Eco Air/CA standard (850mm).....	0468 127 011
12	Air hose Eco Air/CA standard (1000mm)	0700 002 055
12	Air hose Eco Air/CA heavy-duty (850mm)	0700 002 081
13	Clear inner grinding lens.....	0700 000 238
14	Cover lens 107 x 88, pack of 10	0700 000 277
15	Visor holder	0700 000 347
16	Screw set visor holder	0700 000 048
17	Holder for welding glass 90 x 110 incl. screws	0700 000 380
18	Mounting frame.....	0700 000 235
19	Cassette Albatross 4000X 9-13	0700 000 261
20	Head and face seal Albatross 4000X prepared for hard hat and fresh air	0700 000 233
21	Air hose (left and right) incl. adapter for Origo™ Air.....	0700 002 089
22	Safety glass inside 51 x 108 Albatross 4000X 9-13, pack of 10.....	0700 000 228
23	Holder for Albatross 4000X cassette, incl. screws.....	0700 000 237
*	Auto-Shade DIN 10, 60 x 110, incl. protective glass DIN 2	0700 000 029

* Not shown. For accessories such as magnifying glass, hard hats etc., see page 42-46. Spares for Eco Air, see page 53.

Albatross 1000



Standard hard hat

Fresh air unit

Albatross 4000X and 4000X 9-13



Standard hard hat

Fresh air unit

Albatross 4000X and 4000X 9-13 Hard Hat & Fresh Air Unit



Helmets, Masks & Screens

Albatross Welding Helmets – Spares

Spares for Albatross 1000 standard /hard hat/ fresh air unit

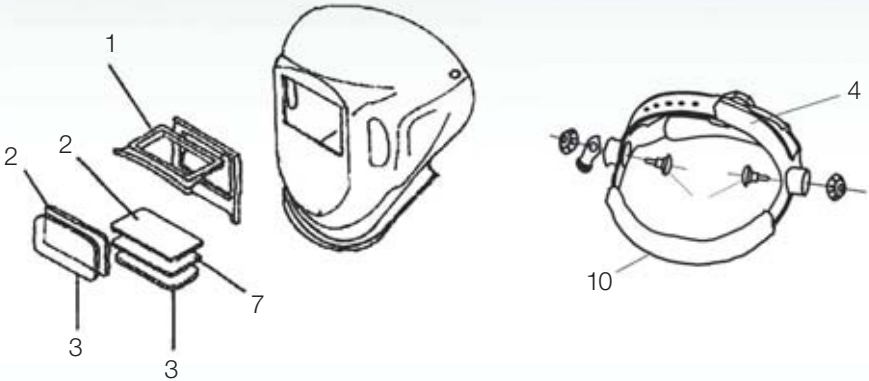

Spares for Albatross 4000X/4000X 9-13 standard /hard hat/ fresh air unit

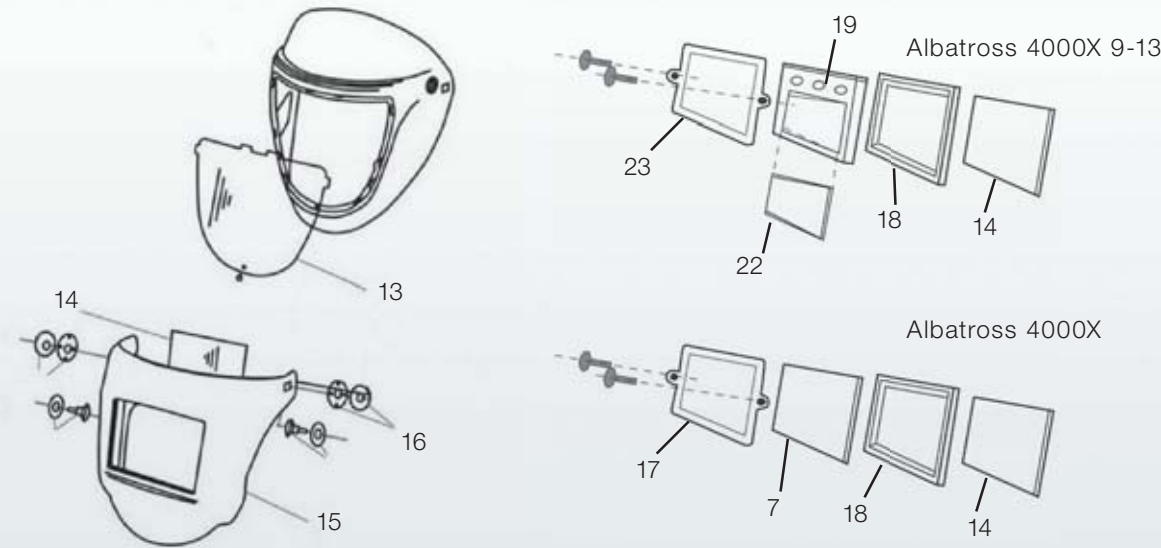

Unique spare parts for Albatross 1000, 4000X and 4000X 9-13 prepared for fresh air

Unique spare parts for Albatross 4000X and 4000X 9-13 prepared for hard hat & fresh air

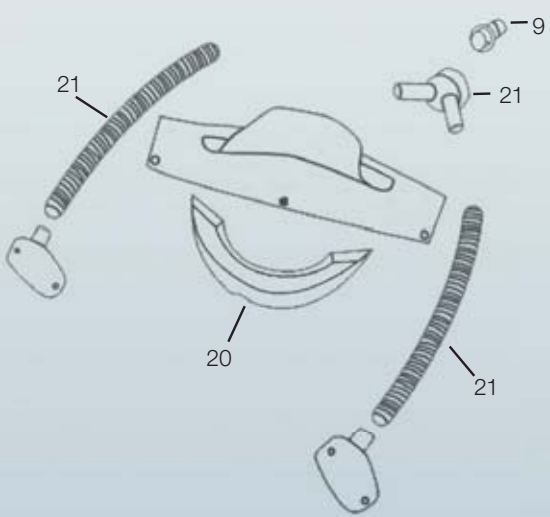
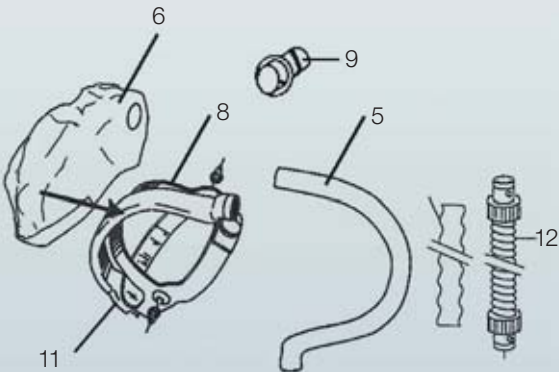

Helmets, Masks & Screens

Globe Arc – A Multi Process Helmet

The Globe Arc helmet has been designed to provide the ideal protection for all kinds of metal working. The inner lens in combination with the outer lens provide full protection against IR, UV and visible light making it suitable for welding. The inner lenses are available in a number of different shades; DIN 2, DIN 3 and DIN 5. The helmet can therefore also be used for grinding, gas cutting, gas welding and plasma cutting.



Helmets, Masks & Screens

Globe Arc – Combinations



Globe Arc Welding and Grinding Helmet

The Globe Arc is a unique design in flip front welding and grinding helmets. The visor provides effective protection from UV and IR radiation when the visor is both open and closed, and is available in different shade levels. The helmet is equipped with a strong and comfortable head gear.

Globe Arc Shade 7 (Inner shade 3, outer shade 5)	0700 000 308
Globe Arc Shade 10 (Inner shade 3, outer shade 8)	0700 000 947
Globe Arc Shade 11 (Inner shade 2, outer shade 10)	0700 000 943



Globe Arc Welding and Grinding Helmet with Hard Hat

Globe Arc offers the welder the unique possibility of removing the hard hat with one hand movement. This means optimum safety and the best ergonomics for the welder – the helmet is used when required, while the neck is not put under strain unnecessarily. The welding helmet's usual head harness is replaced with the unique helmet adapter, which secures the hard hat in place. The hard hat is made of ABS and only weighs 300g. Available in six different colours. Supplied with sweat band. CE approved according to EN 397.



Concept hard hat available in six colours!

Globe Arc DIN 7 (3+5)	0700 000 308
Globe Arc DIN 10 (3+8)	0700 000 947
Globe Arc DIN 11 (2+10)	0700 000 943
Helmet adapter Universal Concept	0700 001 005
Hard hat Concept yellow	0700 000 052
Hard hat Concept white	0700 000 135
Hard hat Concept blue	0700 000 136
Hard hat Concept green	0700 000 137
Hard hat Concept red	0700 000 138
Hard hat Concept orange	0700 000 142
Sweat band Concept hard hat, pack of 10	0700 000 140
Head harness Concept hard hat, pack of 10	0700 000 141
Hearing protection Universal SNR 29 dB	0700 001 009
Hearing protection Universal with FM-radio SNR 29 dB	0700 001 010

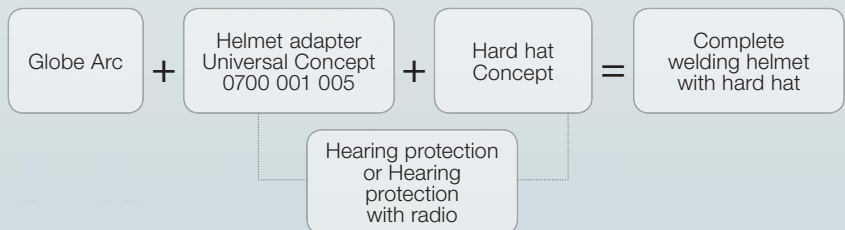

Helmets, Masks & Screens

Globe Arc – Respiratory & Spares



Globe Arc Welding and Grinding Helmet Prepared for Fresh Air

Globe Arc prepared for fresh air are adapted for the Origo Air fresh air unit. Welding helmets are supplied fully assembled with flame-proof head and face seal and air duct. CE approved.

Globe Arc DIN 10 prepared for fresh air	0700 000 935
Globe Arc DIN 11 prepared for fresh air	0700 000 936
Origo Air	0700 002 100

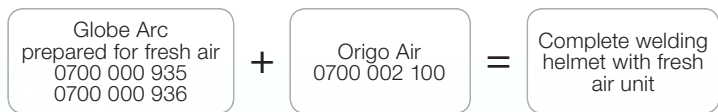

Spares for Globe Arc

1 Hinge Set	0700 000 267
2 Large inner clear Visor	0700 000 238
2 Large Inner Visor DIN 2	0700 000 239
2 Large Inner Visor DIN 3	0700 000 240
2 Large Inner Visor DIN 5	0700 000 241
3 Outer Flip Visor DIN 5	0700 000 242
3 Outer Flip Visor DIN 8	0700 000 247
3 Outer Flip Visor DIN 10	0700 000 248
4 Flip Up Holder	0700 000 249
5 Headgear ESAB Pro	0700 000 243
6 Sweat Band ESAB Pro, pack of 2	0700 000 244

For accessories such as magnifying glass, hard hats etc., see page 42-46.

Spares for Globe Arc Prepared for Fresh Air

1 Sweat band ESAB Pro prepared for fresh air, pack of 2	0700 000 274
2 Head and face seal	0700 000 951
3 Air duct incl. head harness ESAB Pro	0700 002 102

Spares for Origo Air, see page 55.

Spares for Globe Arc

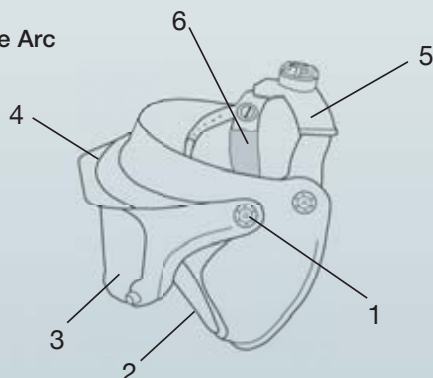

Spares for Globe Arc Prepared for Fresh Air

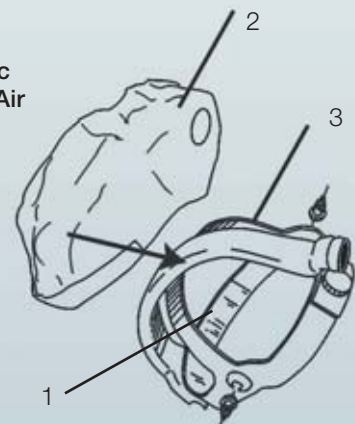



Helmets, Masks & Screens

Eco Arc II Welding Helmets

The new Eco Arc II is the latest development in flip up passive welding helmets. With a light weight Poly Propylene Shell, and outstanding facial protection, this helmet is suitable for all positional welding. Available in three flip front options, the helmet also adopts the new Eco Head Gear, with 5 rake positions. The helmet is supplied complete with outer protection lens, shade 11 mineral glass and the unique large internal protection lens.



Helmets, Masks & Screens

Eco Arc II Welding Helmet and Spares



Eco Arc II Helmets

Eco Arc II 60 X 110 kit of 20	0700 000 760
Eco Arc II 60 X 110 Individual packed	0700 000 761
Eco Arc II 90 X 110 kit of 20	0700 000 762
Eco Arc II 51 X 108 kit of 20	0700 000 763

* Kit helmets are delivered unassembled in boxes with 20 x helmet shells, head harnesses, flip-ups, welding glass DIN 11, protective glass in plastic and instruction manuals for each item.

** Individual packed helmets are delivered complete in plastic bags with cases.

Spares for Eco Arc II

1 Sweat Band	0700 000 244
2 Inside Cover Lens Eco Arc.....	0700 000 252
3 Spatter Lens 60 x 110.....	0160 307 001
3 Spatter Lens 90 x 110.....	0160 307 004
4 Spatter Lens 51 x 108.....	0160 307 002
4 Lens Retaining Clip 60 x 110.....	0700 000 255
5 Lens Retaining Clip 90 x 110	0700 000 256
5 Lens retaining Clip 51 x 108.....	0700 000 257
6 Welding Filter 60 x 110	0160 292 003
6 Welding Filter 90 x 110	0760 031 633
6 Welding Filter 51 x 108	0760 031 603
* Leather chest protector for welding helmet	0700 000 062
* Leather head and chest protector for welding helmet	0700 000 063

* Not shown.

Spares for Eco Arc II

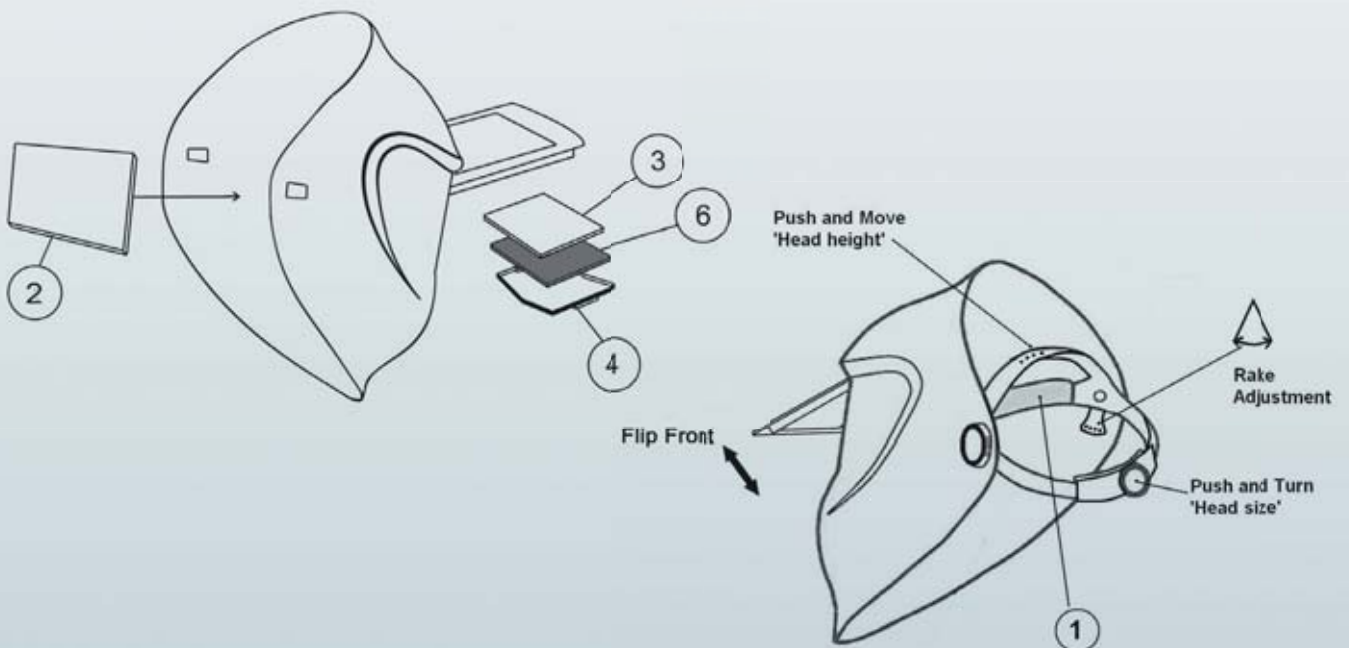

Helmets, Masks & Screens

Euromask Welding Helmet



Euromask

Euromask is a helmet for welding and cutting that provides effective protection from UV and IR radiation. The visor must always be down when welding. The large field of vision provides effective protection for the eyes when grinding. Euromask can be combined with various IR and UV protectors. Also available with a protective helmet or prepared for use with a fresh air unit.

Euromask DIN 10 (1,7 + 8)	0000 500 501
Euromask DIN 11 (1,7 + 10)	0000 500 500



Euromask Welding Helmet with Hard Hat

Euromask offers the welder the unique possibility of removing the hard hat with one hand movement. This means optimum safety and the best ergonomics for the welder – the helmet is used when required, while the neck is not put under strain unnecessarily. The welding helmet's usual head harness is replaced with the unique helmet adapter, which secures the hard hat in place. The hard hat is made of ABS and only weighs 300g. Available in six different colours. Supplied with sweat band. CE approved according to EN 397.



Concept hard hat available in six colours!

Euromask DIN 10 (1,7 + 8)	0000 500 501
Euromask DIN 11 (1,7 + 10)	0000 500 500
Helmet adapter Universal Concept	0700 001 005
Hard hat Concept yellow	0700 000 052
Hard hat Concept white	0700 000 135
Hard hat Concept blue	0700 000 136
Hard hat Concept green	0700 000 137
Hard hat Concept red	0700 000 138
Hard hat Concept orange	0700 000 142
Sweat band Concept hard hat, pack of 10	0700 000 140
Head harness Concept hard hat, pack of 10	0700 000 141
Hearing protection Universal SNR 29 dB	0700 001 009
Hearing protection Universal with FM-radio SNR 29 dB	0700 001 010

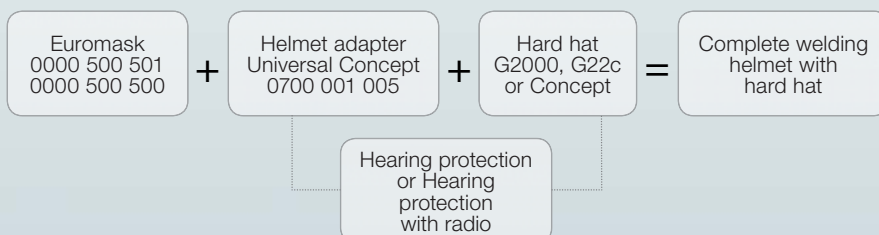

Helmets, Masks & Screens

Euromask Welding Helmet – Spares



Euromask welding helmet prepared for fresh air

Euromask welding helmets prepared for fresh air are adapted for the Eco Air fresh air unit. Welding helmets are supplied fully assembled with flame-proof head and face seal and air duct. CE approved.

Euromask DIN 10 prepared for fresh air	0700 000 901
Euromask DIN 11 prepared for fresh air	0700 000 902
ESAB Air 160-8H Complete (UK)	0700 002 879

Spares for Air 160, see page 54.

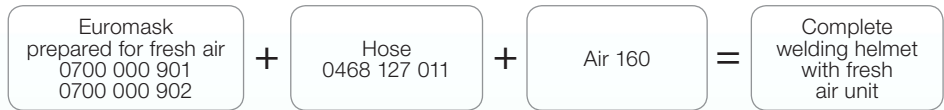

Spares for Euromask

Chin cover.....	0000 500 522
Visor frame.....	0000 500 511
Head gear.....	0000 500 519
Visor DIN 5.....	0000 500 525
Visor DIN 8.....	0000 500 514
Visor DIN 9.....	0700 500 535
Visor large DIN 8.....	0000 500 318
Visor DIN 10.....	0000 500 515
Visor large DIN 10.....	0349 501 088
Visor large DIN 11.....	0700 500 535
UV protector clear (inner glass).....	0000 500 526
UV protection DIN 1.7 (inner glass).....	0000 500 512
UV protection DIN 3 (inner glass).....	0000 500 513
UV protection DIN 5 (inner glass).....	0000 500 524
* Leather chest protector for welding helmet.....	0700 000 062
* Leather head and chest protector for welding helmet.....	0700 000 063

* Not shown.

Spares for Euromask Prepared for Fresh Air

Air Hose standard (850mm).....	0468 127 011
Air Hose long (1000mm).....	0700 002 055
Air Hose Heavy-duty (850mm).....	0700 002 081
Face seal for fresh air helmet.....	0700 002 078
Air duct Euromask.....	0700 002 002

Spares for Air 160/200, see page 54.

Helmets, Masks & Screens

Passive Welding Screens



Leather Mask

This leather mask can be used when there is not enough space for welding with a conventional welding helmet. Glass size 90 x 110mm.

Leather mask	0000 593 221
--------------	---------------------



SF11 Helmet Short Shell

A traditional short shell helmet made from high performance glass fibre. Weight 600g. Lens aperture 108 x 83mm (4 1/4" x 3 1/4").

SF11	0700 654 889
Rubber glass holder Pk 5	0701 380 163
Helmet head band foam Pk 10 (white)	0701 415 838



SF8 Lightweight Helmet

A lightweight thermoplastic helmet weighing 420g. Lens aperture 108 x 83mm (4 1/4" x 3 1/4").

SF8	0701 380 430
Rubber glass holder Pk 5	0701 380 163
Helmet head band foam Pk 10 (white)	0701 415 838



SF10 Flip Front Helmet

A short shell fibreglass helmet in traditional design. Lens aperture 108 x 51mm (4 1/4" x 2").

SF10	0700 654 859
------	---------------------



Helmets, Masks & Screens

Passive Welding Screens



Hand Screen Delta

Welding screen that protects the face as well as the hand. The window size is 90 x 110mm. Welding glass not included.

Hand Screen Delta DIN 10

0700 000 394



Hand Screen SF12

Deep shell fibre glass screen. Weighs 525g. Lens aperture 108 x 83mm (4 1/4" x 3 1/4").

Hand Screen SF12

0700 654 890

Does not include welding lens



Hand screen SF2

Flat fronted fibreglass hand screen. Weight 450g. Lens aperture 108 x 83mm (4 1/4" x 3 1/4").

Hand Screen SF2

0700 655 002

Does not include welding lens



Hand Screen E

A safe welding screen with replaceable welding glass, 60 x 110mm.

Hand Screen E

0332 109 880





Filter & Spatter Lenses



Filter Lenses

Traditional glass filter lenses of excellent UV and IR protection and thermal stability. Solid glass lenses are not robust and must be used with a polycarbonate backing lens and a glass or plastic cover lens.

Filter Lens 60 x 110 shade 8 Pk 25	0160 292 000	Filter Lens 51 x 108 shade 13 Pk 25	0760 031 605
Filter Lens 60 x 110 shade 9 Pk 25	0160 292 001	Filter Lens 50mm Diameter shade 4	0000 665 604
Filter Lens 60 x 110 shade 10 Pk 25	0160 292 002	Filter Lens 50mm Diameter shade 5	0000 665 605
Filter Lens 60 x 110 shade 11 Pk 25	0160 292 003	Filter Lens 50mm Diameter shade 6	0000 665 606
Filter Lens 60 x 110 shade 12 Pk 25	0160 292 004	Filter Lens 9EW 108 x 83	
Filter Lens 60 x 110 shade 13 Pk 25	0160 292 005	(4 ¹ / ₄ " x 3 ¹ / ₄ ") Pk 10	0701 416 369
Filter Lens 90 x 110 shade 9 Pk 25	0760 031 631	Filter Lens 10EW 108 x 83	
Filter Lens 90 x 110 shade 10 Pk 25	0760 031 632	(4 ¹ / ₄ " x 3 ¹ / ₄ ") Pk 10	0701 416 371
Filter Lens 90 x 110 shade 11 Pk 25	0760 031 633	Filter Lens 11EW 108 x 83	
Filter Lens 90 x 110 shade 12 Pk 25	0760 031 634	(4 ¹ / ₄ " x 3 ¹ / ₄ ") Pk 10	0701 416 373
Filter Lens 90 x 110 shade 13 Pk 25	0760 031 635	Filter Lens 12EW 108 x 83	
Filter Lens 50 x 105 shade 9 Pk 25	0590 028 216	(4 ¹ / ₄ " x 3 ¹ / ₄ ") Pk 10	0701 416 375
Filter Lens 50 x 105 shade 10 Pk 25	0590 028 217	Filter Lens 13EW 108 x 83	
Filter Lens 50 x 105 shade 11 Pk 25	0590 028 218	(4 ¹ / ₄ " x 3 ¹ / ₄ ") Pk 10	0701 416 376
Filter Lens 50 x 105 shade 12 Pk 25	0590 028 219		
Filter Lens 50 x 105 shade 13 Pk 25	0590 028 220		
Filter Lens 51 x 108 shade 9 Pk 25	0760 031 601		
Filter Lens 51 x 108 shade 10 Pk 25	0760 031 602		
Filter Lens 51 x 108 shade 11 Pk 25	0760 031 603		
Filter Lens 51 x 108 shade 12 Pk 26	0760 031 604		

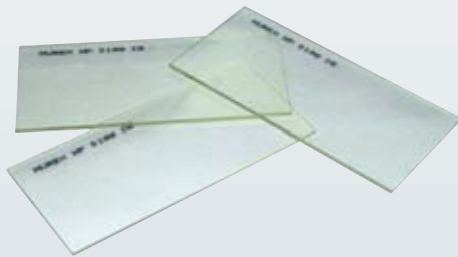

Cover Lenses

A suitable cover lens must be used to protect the filter lens from spatter and damage.

Cover Lens 60 x 110 glass Pk 25	0291 102 701
Cover Lens 60 x 110 plastic Pk 100	0160 307 001
Cover Lens 90 x 110 glass Pk 100	0760 031 040
Cover Lens 90 x 110 plastic Pk 100	0160 307 004
Cover Lens 51 x 108 glass Pk 25	0760 031 010
Cover Lens 51 x 108 plastic Pk 100	0160 307 002
Cover Lens 50 x 105 glass Pk 100	0590 028 221
Cover Lens 50 x 105 plastic Pk 100	0590 028 222
Cover Lens 98 x 75 glass Pk 100	0000 915 058
Cover Lens 98 x 75 plastic Pk 100	0000 915 097
Cover Lens 108 x 83 (4 ¹ / ₄ " x 3 ¹ / ₄ ") glass Pk 10	0701 416 341
Cover Lens Diameter 50mm glass Pk 50	0000 665 600
Cover Lens Diameter 50mm plastic Pk 50	0000 665 618

CR 39 Cover lenses

Cover Lens CR39 108 x 51 (4 ¹ / ₄ " x 2) Pk 10	0701 416 348
Cover Lens CR39 108 x 83 (4 ¹ / ₄ " x 3 ¹ / ₄ ") Pk 10	0701 416 350
Cover Lens CR39 60 x 110 Pk 10	0701 416 352
Cover Lens CR39 90 x 110 Pk 10	0700 000 139

Accessories Welding Helmets

Accessories for all ESAB's Welding Helmets



Chest Protector and Head/Neck Protector for Welding Helmet

Chest protector and Head/Neck protector are recommended as supplementary protection for ESAB's welding helmets. Both are made of leather to give the best durability against welding spatter. The chest protector functions as a bib and gives extra protection to the throat and chest. The chest protector has an integrated rubber profile, which is threaded on to the underside of the welding helmet. The Head and Neck protector protects that part of the head and neck not protected by the welding helmet. The protector has an integrated rubber profile, which is threaded on to the upper side of the welding helmet. Apply a little liquid soap to the rubber profile to facilitate installation.

Leather chest protector for welding helmet **0700 000 062**

Leather head and chest protector for welding helmet **0700 000 063**

Chest and head protection is compatible with all ESAB welding helmets



ESAB Easy-Lite

The Easy-Lite is a small but effective light source, that can be easily attached to your welding helmet, hard hat, spectacle or anywhere that additional light is required. The Easy-Lite has also proven to be an excellent tool for adapting to a stainless steel inspection mirror, the bright LED is perfect for highlighting the weld in difficult places where there is insufficient light. The LED is turned on by a simple switch, and the battery has over 50 hours of life.

ESAB Easy-Lite

0700 014 040

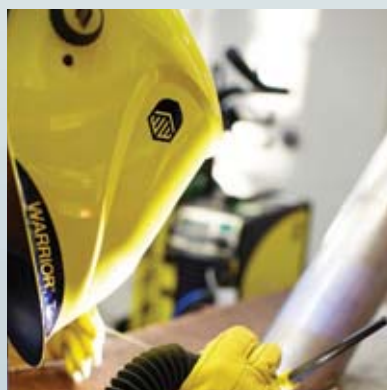

Accessories Welding Helmets



Magnifying Lenses

All welding helmets can be equipped with magnifying glass to correct vision when the welder is not wearing glasses.

Magnifying glass is mounted from the inside of the helmet, no adapter is required. Fits New-Tech™, Aristo® Tech, Origo™ Tech and Eye-Tech II.

Magnifying glass +1.0 diopter	0700 000 084
Magnifying glass +1.5 diopter	0700 000 085
Magnifying glass +2.0 diopter	0700 000 086
Magnifying glass +2.5 diopter	0700 000 087

For Warrior™ Tech the magnifying glass is mounted on the inside of the helmet, no adapter is required.

For Albatross 4000X the magnifying glass is clamped on the inside of the helmet and is slightly smaller than the welding glass. A mounting frame is required for Eye-Tech™.

Magnifying glass +1.0 diopter	0367 951 001
Magnifying glass +1.5 diopter	0367 951 002
Magnifying glass +2.0 diopter	0367 951 003
Magnifying glass +2.5 diopter	0367 951 004
Mounting frame for magnifying glass Eye-Tech™	0700 000 030



Helmet Spacer Kit

The ESAB helmet spacer kit has been designed to increase the width of the shell from the headgear allowing a pair of Ear defenders to be worn under the helmet.

Helmet Spacer Kit	0700 001 004
-------------------	---------------------



ESAB Mask Spray

The ESAB mask spray should be applied to the cover lenses in a helmet to keep them mist free and clean. 300ml.

Mask Spray 300ml Pk 6	0700 013 026
-----------------------	---------------------

Hard Hats & Hearing Protection

ESAB's new hard hat hearing adapter makes it possible to combine all ESAB's welding helmets with the most common protective helmets. Hearing protectors, either a traditional model or one with a radio, can be added to all combinations.

This system enables a much more comprehensive choice of welding helmets, as you now can use the same basic model of the helmet by removing the headband and replacing it with the helmet adapter. There is no need for a separate helmet model of a welding mask. The welding mask can be quickly removed from the helmet by lifting the hearing protectors to top position and pulling the helmet from the adapter. Correspondingly, the mask can be locked to the helmet by lowering the hearing protectors to lowest position.

After welding you can quickly remove the mask from the helmet, so working can continue with the same helmet and hearing protectors still on. No tools are needed for the removal.



Hearing protection, standard or with FM-radio, is easily mounted on the Universal helmet adapter.



Universal helmet adapter makes it possible to combine a hard hat with any ESAB welding helmet.



Hearing protection with radio

- Li-Ion battery with up to 80 hours operation
- Automatic channel seek
- Memory for last channel selection
- Narrow profile
- Digital setting, selected channel always correctly set
- DX function and searching for local channels
- Short antenna



Hearing protection standard

- Narrow profile

Hard Hats & Hearing Protection



Lock positions – with/without hearing protection

When welding is complete the welding helmet can be removed by turning the black helmet adapter, so that the arrow points upwards. If hearing protection is used it is even easier, turn the hearing protectors on the welding helmet upwards and the helmet adapter is automatically turned to the correct position. Then pull the welding helmet forward, and it comes free from the hard hat. No tools are required and the hard hat never needs to be removed to remove the welding helmet.

Fixed in folded up position

When the welding helmet is raised to the maximum folded up position it is automatically fixed. By “nodding” the head the welding helmet falls into place again. Just how welders want it!

Combination possibilities

Select any standard ESAB welding helmet Supplement with the Universal kit for the hard hat that you use. Supplement with hearing protection, standard or with FM radio as necessary. Put together – ready!

Welding Helmet	Adapter	Hearing Protection	Complete System
Aristo® Tech HD New-Tech™ Warrior™ Tech Origo™ Tech Albatross Globe Arc Eco Arc Euromask	Universal Kit 1: 0700 001 005 Kits contain: • 1 pair yellow mountings (L + R) for ESAB welding helmet • 2 x black adapters for the hard hat • 2 lock rings • 2 black locking knobs • 1 pair black arms (L + R) for the welding helmet • Installation instructions	Standard - SNR 29 dB 0700 001 009	Welding helmet with a protective Hard hat and hearing protector
	Hard Hat		Complete System
	For hard hats please see page 46.	With radio - SNR 29 dB 0700 001 010	Welding helmet with a protective Hard hat, hearing protector and radio

Spares			
	Head seal, short 0000 595 216	Head seal, long 0700 000 093	Leather chest protection 0700 000 062

Hard Hats & Hearing Protection

Other Hard Hats & Hearing Protection



Concept hard hat available in six colours!

Hard Hat Concept

The hard hat for New-Tech™, Aristo® Tech, Warrior™ Tech, Origo™ Tech, Eye-Tech™ and Globe Arc provides the user with the lightest, strongest and most comfortable helmet available. The helmet is manufactured from ABS material and weighs only ~300g. The head gear is equipped with a ratchet adjustment for easy adjustment and comfort. Approved to EN 397.

Hard hat Concept Yellow	0700 000 052
Hard hat Concept White	0700 000 135
Hard hat Concept Blue	0700 000 136
Hard hat Concept Green	0700 000 137
Hard hat Concept Red	0700 000 138
Hard hat Concept Orange	0700 000 142
Helmet adapter New-Tech™ for hard hat Concept	0700 000 230
Universal hard hat adapter	0700 001 005
Sweat band Concept hard hat, pack of 10	0700 000 140
Head harness Concept hard hat, pack of 10	0700 000 141



Hard hat Peltor G3000N and G22c

Hard hat Peltor G3000N is specially developed for Albatross welding helmets. The hard hat is made of UV stabilised ABS and only weighs 340g. There are ventilation holes at the top for the best ventilation of the whole helmet. Mounting for easy installation of hearing protection. Hard hat G22c fits Euromask welding helmets. CE approved according to EN 397.

Hard hat G3000N Albatross Yellow	0468 051 881
Helmet adapter Universal Concept/Peltor G3000N	0368 975 883
Hard hat G22c Euromask Yellow	0468 051 880



Hearing Protection Peltor

Peltor hearing protectors are available in two different versions; One that can be attached to a protective helmet, one with neck support, one with head support. All of these provide effective protection at different decibel levels.

Hearing protector for G2000c, yellow SNR 26 dB *	0367 420 003
Hearing protector with neck support, SNR 26 dB	0700 001 880

* Helmet mounting fits 3M/Peltor hard hats G22c, G2000 and G3000N.



Eco Air

Respiratory Equipment

Why choose ESAB Powered Air Purifying Respirator (PAPR) systems?

The welding fume generated from the open arc welding process contains airborne particles released from the consumables and the material being welded. More than 90% of the fume arises from vaporisation of the consumable electrode, wire or rod as material is transferred across the arc or flame. Welding fume particles can be hazardous as they can penetrate the innermost parts of the lungs.

Long term exposure to welding fumes may affect the body's respiratory system, for example through substance inhalation and release into the blood system which can result in long term health problems.

ESAB recommends the use of powered air purifying respirators (PAPR) in combination with ESAB's welding helmet. PAPR units operate by filtering the air through a battery powered unit, which is then supplied into the breathing zone inside the helmet.

ESAB PAPR systems are fitted with a P3 main filter which, if used correctly, can filter out up to 99.8%. All ESAB CE certified systems fully comply to EN 12941 achieving a minimum level of THP2 and highest level of THP3.

The PAPR should always be used, cleaned, inspected and maintained in accordance with the operating and maintenance instructions provided. A risk assessment should be carried before use to ensure the PAPR system is suitable for the risks involved, the conditions at the place where exposure to the risk may occur, and the period for which it is worn, taking into account the state of health of the person who may wear the equipment, the work to be undertaken and the work environment.



Respiratory Equipment

Choice of Filter

Prefilter

The air first passes through the fresh air unit prefilter, which filters larger particles, which extends the life of the main filter and reduces the running cost of the fan. Prefilter with integrated carbon filter reduces unwanted odours.

Main filter (Particle filter)

ESAB's fresh air fans are always supplied with a main filter of the P3 type, which gives the highest filtration efficiency – 99.8%. The main filter filters out damaging particles in the smoke, both solids and vapour borne. This means that particles containing aluminium, barium, cobalt, chrome, copper, manganese and nickel are caught by the main filter. Particle filter P2 with integrated carbon filter reduces unwanted odours. After passing through the prefilter the remaining dangerous filters are filtered by the main filter. It is recommended that welders who want to minimise unwanted odours use: Prefilter with integrated carbon filter + Particle filter P2 with integrated carbon filter. The main filter consists of a very sensitive filter element that will be damaged if cleaned using compressed air.

ESAB recommends that welders who want to reduce unwanted odours but still want maximum protection from dangerous particles use: Prefilter with integrated carbon filter + Particle filter P3.



Prefilter

Prefilter

Prefilter filters larger particles which extends the life of the main filter and reduces the running cost of the fan. Standard on delivery.

Prefilter, pack of 5
0700 002 023

Prefilter with carbon filter

Prefilter with integrated carbon filter filters out larger particles and reduces unwanted odours.

Prefilter with carbon filter, pack of 10
0700 002 040

Relevant to Aristo Air, Eco Air, Air 160/200 units.

Main filter

Particle filter P3

ESAB's fresh air fans are always supplied with a main filter of the P3 type, which gives the highest filtration efficiency – 99.8%. The particle filter filters out damaging particles in the smoke, both solids and vapour borne. Approved according to EN 12941 classification THP3/TH3PSL.

Particle filter P3, pack of 1
0700 002 024

Particle filter P2 with carbon filter

Particle filter P2 with integrated carbon filter is recommended for welders who wish to avoid unwanted odours. This particle filter has the next highest filtration efficiency – 98.0%. The particle filter filters out damaging particles in the smoke, both solids and vapour borne. Approved according to EN 12941, classification THP2/TH2PSL.

Particle filter P2 with carbon filter, pack of 1
0700 002 041

Respiratory Equipment

ESAB Aristo® Air

The Aristo® Air PAPR (Powered Air Purifying Respirator) system combined with the Aristo® Tech helmet, offers heavy duty protection from welding fume and dust when welding, gouging & grinding. The unit features the latest in PCB Board technology, allowing the welder to adjust the air flow from 170 L/min to 210 L/min to suit the environment and application. This is highlighted by an LED airflow indicator on top of the unit. The Aristo® Air is equipped with audio & visual blocked filter and low battery alarms, offering extra safety for the welder.

The strong physical construction of the Aristo® Air, makes it extremely robust and suitable for all heavy duty welding applications.

- User adjustable air flow 170/210 L/min
- Li-Ion battery pack (up to 8hr duration @ 210L/min)
- P3 filter and pre-filter
- International intelligent charger (interchangeable pins)
- Audio/visual blocked filter and low battery alarms
- LED air flow indicator
- Battery charge LED indicator
- Flat push button membrane switch
- Supplied with 'new style' comfort pad



Lightweight at only 1kg



Battery life indicator



Adjustable airflow

Aristo® Air

The Aristo® Air PAPR unit is delivered complete and is ready to use. Contents include: Air unit with air hose and hose cover, lightweight Li-Ion battery, intelligent charger, comfort pad and P3 filter. CE approved to EN 12941:2008 for use together with Aristo® Tech HD and Warrior Tech™

Aristo® Air Complete

0700 002 174



Respiratory Equipment

ESAB Eco Air

Eco Air is a robust fresh air fan, that gives a stable airflow of 170 litres fresh air/min. Supplied with both prefilter and Particle filter P3 of highest protection class. Carbon filter available as an accessory. Eco Air also has an integrated alarm (audible signal) that warns of low battery level or that the blocked filter needs changing. The battery can be used for up to 8 hours. The intelligent battery charger (IQ) checks that the battery is optimally charged and prevents overheating, which extends the service life of the battery. Only weighs 1170g including belt.



- Constant air flow 170 litres fresh air/min
- High quality NiMH battery that lasts for up to 8 hours
- Supplied with Particle filter P3 of highest protection class, together with efficient prefilter
- Intelligent battery charger checks that the battery is optimally charged and prevents overheating
- Integrated alarm (audible signal) warn of blocked filter or low battery level
- Strong construction – can with stand >100kg static load
- Large comfort pad reducing muscle strain



Eco Air

Eco Air is a robust fresh air fan, that gives a stable airflow of 170 litres fresh air/min. Supplied complete with particle filter P3, air hose 850mm with hose sleeve, chargeable NiMH battery, intelligent battery charger and ergonomic belt. CE approved according to EN 12941:2008 for use together with Aristo[®] Tech, Origo[™] Tech, Albatross 1000/4000X and Warrior[™] Tech.

Eco Air Complete (EU and UK) including air hose

0700 002 175

Respiratory Equipment

Spares for PAPR units

Spares for Aristo® Air

1	Air hose standard (850mm)*	0468 127 011
1	Air hose long (1000mm).....	0700 002 055
1	Air hose Heavy-Duty (850mm).....	0700 002 081
2	Comfort pad Aristo® Air	0700 002 162
3	Motor unit Aristo® Air.....	0700 002 163
4	P3 filter	0700 002 024
4	P2 filter	0700 002 041
5	Pre filter Pk 5.....	0700 002 023
5	Carbon pre filter Pk 10.....	0700 002 040
6	Intelligent charger Aristo® Air**	0700 000 471
7	Waist belt.....	0700 002 027
8	Battery Aristo® Air	0700 002 164
9	Proban hose cover	0349 501 071
10	Aristo® Air door	0700 002 166

* This Air hose is supplied with the Aristo® Air unit as standard. This can be used to connect the Aristo® Air to the Aristo® Tech HD & Warrior™ Tech air fed headshields.

** Intelligent charger comes with multi plug adaptors for use in Europe, USA & Australia. This charger is only suitable for use with the Aristo® Air Li-Ion battery.

Spares for Aristo® Air

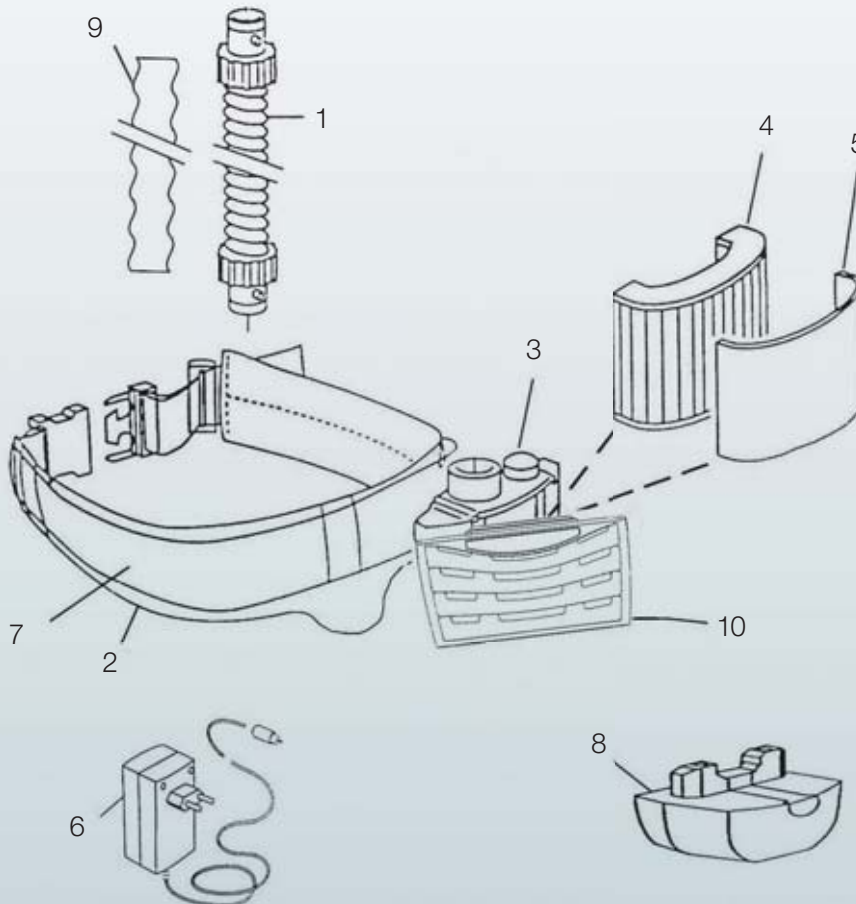

Respiratory Equipment

Spares for PAPR units

Spares for Eco Air

1	Air hose standard (850mm)*	0468 127 011
1	Air hose long (1000mm)	0700 002 055
1	Air hose Heavy-duty (850mm).....	0700 002 081
1	Air hose Albatross 3000X.....	0700 002 032
2	Comfort pad standard.....	0700 002 021
2	Comfort pad large.....	0700 002 022
3	Motor unit Eco Air.....	0700 000 393
4	P3 filter	0700 002 024
4	P2 filter carbon.....	0700 002 041
5	Pre filter Pk 5.....	0700 002 023
5	Carbon Pre filter Pk 10.....	0700 002 040
6	Intelligent charger Eco Air**	0700 000 470
7	Waist belt	0700 002 027
8	Battery Eco Air	0700 002 144
9	Proban hose cover	0349 501 071
10	HD battery/12 hour.....	0700 002 082

* This Air hose is supplied with the Eco Air unit as standard. This can be used to connect Eco Air unit to the Aristo® Tech HD, Warrior Tech™, Albatross 4000X & Origo™-Tech headshields.

Please note: Adaptor 0700002176 is also required when connecting the air hose to the Albatross & Origo™-Tech head shields.

** Intelligent charger comes with multi plug adaptors for use in Europe, USA & Australia. This charger is only suitable for use with the Eco Air & Air 160/200 Ni-Mh batteries.

Spares for Eco Air

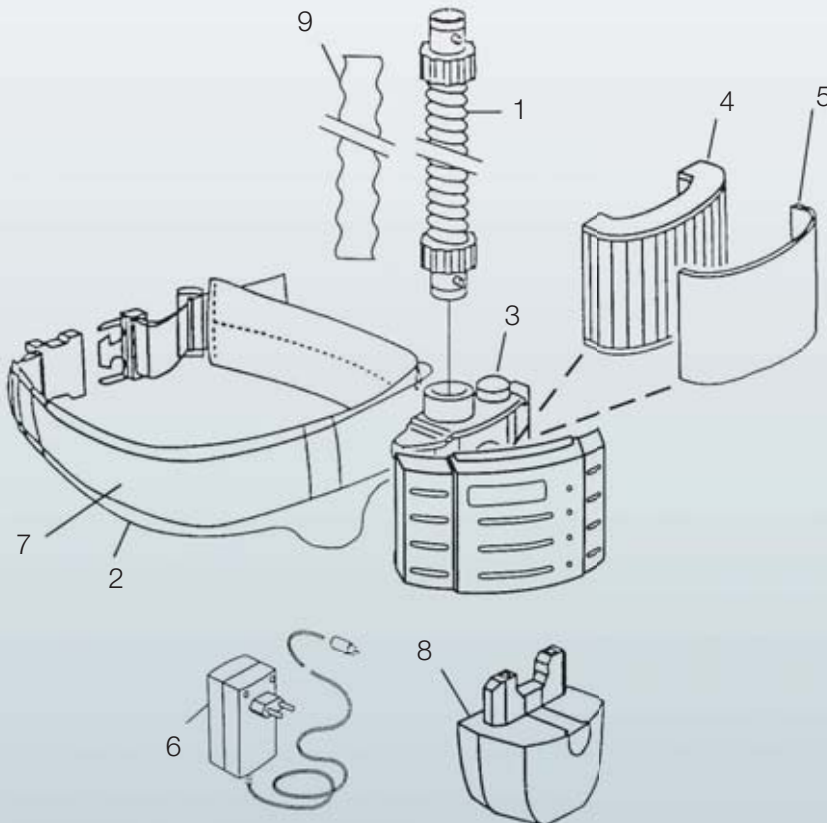

Respiratory Equipment

Spares for PAPR units

Spares for Air 160/200

1	Air hose standard (850mm)*	0468 127 011
1	Air hose long (1000mm)	0700 002 055
1	Air hose Heavy-duty (850mm)	0700 002 081
1	Air hose Albatross 3000 (850mm)	0700 002 032
2	Comfort pad standard	0700 002 021
2	Comfort pad large	0700 002 022
3	Air 160 motor unit	0700 002 042
3	Air 200 motor unit	0700 002 079
4	P3 filter	0700 002 024
4	P2 filter carbon	0700 002 041
5	Pre filter Pk 5	0700 002 023
5	Carbon Pre filter Pk 10	0700 002 040
6	Battery small Air 160	0700 002 013
6	Battery small Air 200	0700 002 144
7	Intelligent charger**	0700 000 470
8	Waist belt	0700 002 027
9	Battery large Air 160	0700 002 014
9	Battery large Air 200	0700 002 082
10	Air 160 IQ kit	0700 002 879
11	Proban hose cover	0349 501 071

* Air hose suitable for Air 160/200 with New-Tech™, Eye-Tech, Eye-Tech II and Euromask.

** Intelligent charger charges all battery types listed for the Air 160/200.

Spares for Air 160/200

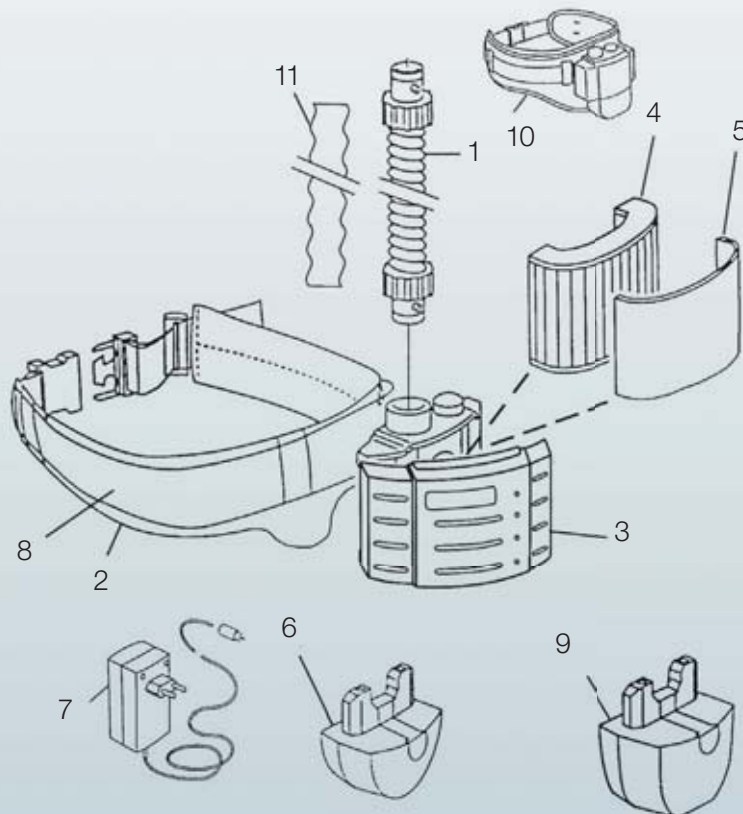

Respiratory Equipment

Spares for PAPR units

Spares for Origo™ Air

1 Air Hose.....	0700 002 103
2 Proban Hose Cover	0700 002 104
3 Motor Unit.....	0700 002 105
4 Filter.....	0700 002 106
5 Charger Adapter	0700 002 107
6 Battery.....	0700 002 108
7 Waist Belt.....	0700 002 109

Spares for Origo™ Air

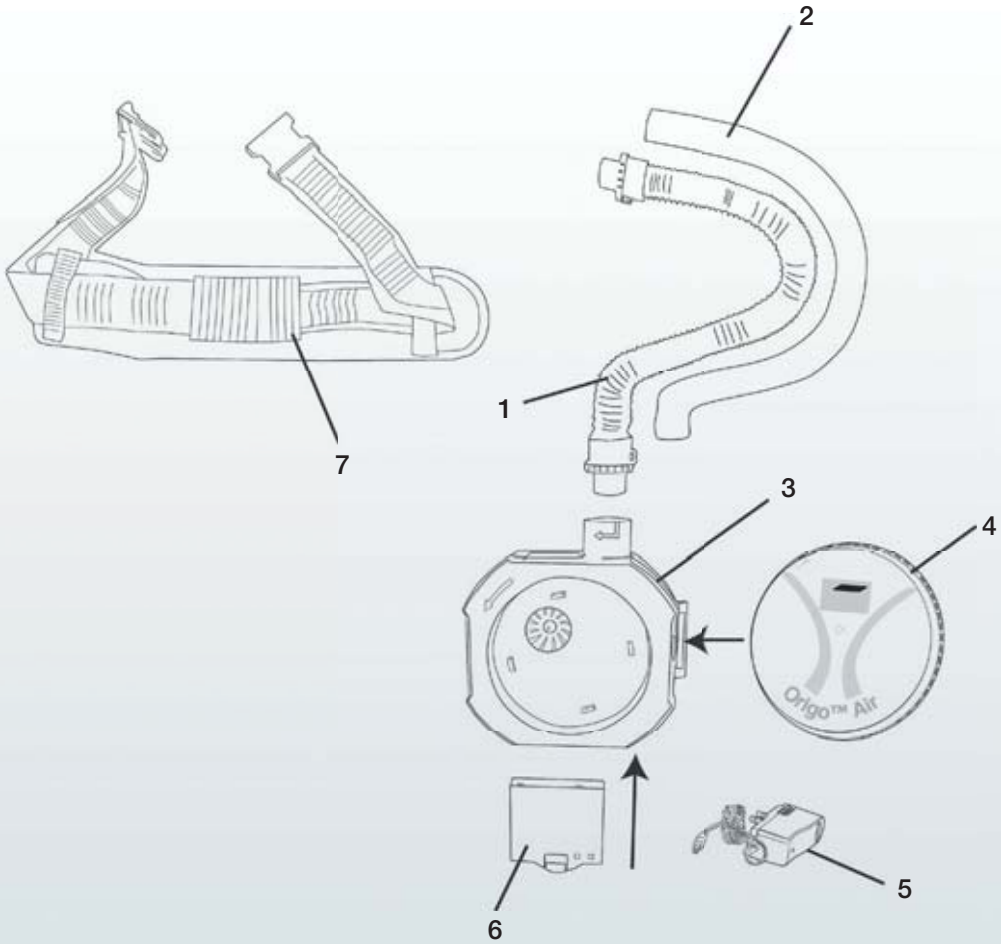

Respiratory Equipment

ESAB Compressed Air Systems (CA)



ESAB Air CA

The waist mounted regulator is pre-set to reduce the air from high to low pressure and has integral low flow warning alarm. The unit is encased to protect the regulator. The regulator is delivered with an air supply connector which connects the air hose to the regulator. The regulator can be combined with Eye-Tech, Eye-Tech II, New-Tech™, grinding/ spraying helmet & Grinding Visor. The unit is supplied complete with waist belt. The maximum input working pressure is 10 bar (145 psi).

ESAB Air CA regulator	0349 501 072
Compressed air hose 10m	0701 416 188
Air hose standard (850mm)	0468 127 011

Spares for compressed air regulator Air CA

Adapter for air hose 850mm	0701 416 178
----------------------------	---------------------



ESAB Compressed Air Filtration Bank

The filter system consists of three filtration units which will remove liquids, solid contaminants, oil vapour and odours from the compressed air supply and provides clean breathing air to the operators. The filtration bank should be used when a clean air supply is not available. The units are fitted with 1/4" (6.4mm) input hose tail adapter, a 0.5-10 bar adjustable regulator, twin output 'quick-snap' style hose connectors for 1 or 2 operators and a gauge as a guide to output pressure. The filtration bank can be supplied for wall mounting or on a portable frame.

Filtration Bank Framed	0700 002 085
Filtration Bank Wall Mounted	0700 002 086

Spares filters for Filtration Bank

Prefilter, Pk 3	0700 002 087
Coalescing Filter	0700 002 088
Charcoal filter	0701 416 187

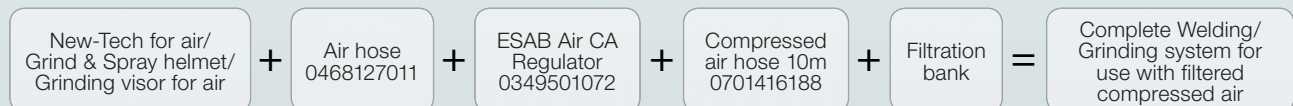

Respiratory Equipment

Air Fed Grinding Visors



Grinding and Spraying Helmet for Air

The system consist of a hard hat combined with a flip up polycarbonate visor. Air is feed into the head piece via an air hose from the air unit. ESAB offer visor covers to protect and increase the life of the visor.

Grinding / spraying helmet including hose **0701 416 189**

Spares for grinding / spraying helmet

Replacement visor clear **0701 416 233**

Replacement visor DIN5 green **0701 500 000**

Visor covers **0701 416 182**

Face seal Pk 5 **0701 416 234**

Brow guard and arms **0700 002 056**

Air Hose **0468 127 011**

Air 160 with Inteligent charger **0700 002 879**

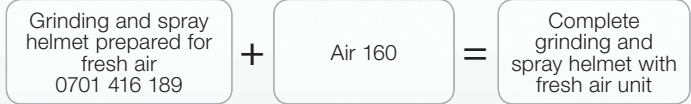

Grinding Visor Prepared for Fresh Air

The grinding visor prepared for fresh air is suitable for fresh air unit Air 160 or compressed air Air CA. The grinding helmet is supplied fully assembled with flame-proof head and face seal and air duct. Fresh air unit purchased separately.

Grinding visor prepared for fresh air (Including hose) **0700 002 915**

Spares for grinding visor prepared for fresh air

Air Hose **0468 127 011**

Face seal, pack of 5 **0700 002 057**

Head seal, pack of 5 **0700 002 058**

Visor transparent **0700 002 059**

Visor screen transparent, pack of 50 **0701 416 182**

Air 160 Inteligent charger **0700 002 879**

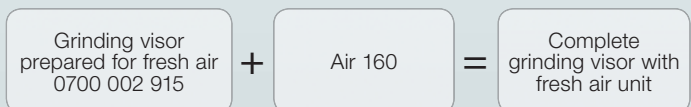



Respiratory Equipment

Filtair Disposable Masks

The ESAB Filtair series has been developed to improve the comfort of disposable respirators whilst maintaining an excellent face fit. Colour coding the range makes identification simple when varying levels of protection may be required. The mesh shell supports the filter media and prevents collapse onto the face and the preformed nose bridge provides comfortable fit eliminating constant adjustment.

The filters use the latest filter technology to promote low breathing resistance and are approved to EN149:2001 (meeting the 120mg load testing).

The Filtair is available as a pre-moulded and a flat version. Depending on the protection level needed and the breathing resistance some models are equipped with a valve. All the masks are fitted with buckle fastening which also allows the wearer to adjust the straps accordingly.



Respiratory Equipment

Filtair Disposable Masks – Moulded



ESAB Filtair Pro 8010

This mask provide P1 protection and is suitable to wear during general dusty duties.

ESAB Filtair Pro P1 'White' Pk 20

0700 002 200

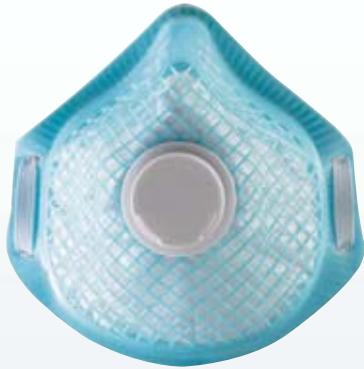

ESAB Filtair Pro 8020V

This mask provide P2 protection and is equipped with a valve to reduce heat and moisture build up inside the respirator. Suitable to wear when sanding painted metals, powder coating and sanding cured resins.

ESAB Filtair Pro P2V 'Blue' Pk 10

0700 002 201

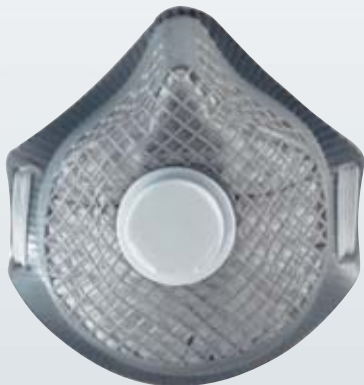

ESAB Filtair Pro 8020CV

This mask provide P2 protection and is equipped with a valve to reduce heat and moisture build up inside the respirator. The carbon layer takes out bad odours. Suitable to wear during welding, brazing, soldering, painting (brush applied), gluing (brush applied) and polyester resins (hand mix).

ESAB Filtair Pro P2CV 'Grey' Pk 5

0700 002 202

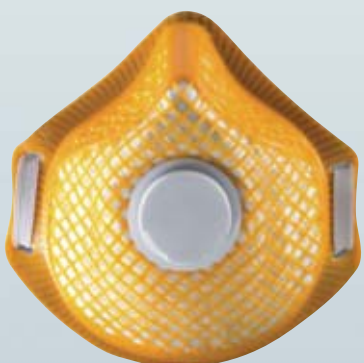

ESAB Filtair Pro 8030V

This mask provide P3 protection and is equipped with a valve to reduce heat and moisture build up inside the respirator. Suitable to wear during molten metal handling, welding, machining, grinding, polishing and finishing.

ESAB Filtair Pro P3V 'Orange' Pk 5

0700 002 203



Respiratory Equipment

Filtair Disposable Masks – Fold Flat



ESAB Filtair Flat A-1

This mask provide P1 protection and is suitable to wear during general dusty duties.

ESAB Filtair Flat P1 'White' Pk 20

0700 002 204

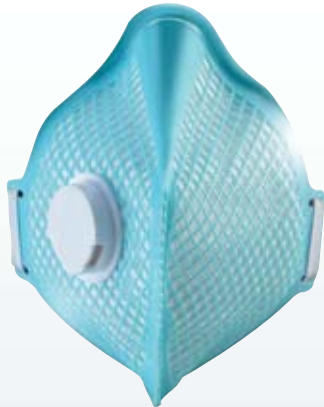

ESAB Filtair Flat A-2V

This mask provide P2 protection and is equipped with a valve to reduce heat and moisture build up inside the respirator. Suitable to wear when sanding painted metals, powder coating and sanding cured resins.

ESAB Filtair Flat P2V 'Blue' Pk 20

0700 002 205



ESAB Filtair Flat A-2CV

This mask provide P2 protection and is equipped with a valve to reduce heat and moisture build up inside the respirator. The carbon layer takes out bad odours. Suitable to wear during welding, brazing, soldering, painting (brush applied), gluing (brush applied) and polyester resins (hand mix).

ESAB Filtair Flat P2CV 'Grey' Pk 20

0700 002 206

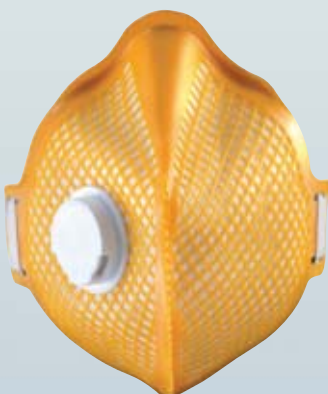

ESAB Filtair Flat A-3V

This mask provide P3 protection and is equipped with a valve to reduce heat and moisture build up inside the respirator. Suitable to wear during molten metal handling, welding, machining, grinding, polishing and finishing.

ESAB Filtair Flat P3V 'Orange' Pk 20

0700 002 207

Spectacles, Goggles & Visors

Aristo[®] Premium Safety Spectacles

ESAB's safety eye wear combines the highest standards of safety and eye protection with excellent features for wearer comfort. This ensures that the eyes are optimally protected during operations. All ESAB spectacles use a Polycarbonate providing protection against impact as well as UV rays.

The Aristo[®] Spec range of safety spectacles combine a high degree of comfort and protection to the user, whilst offering useful features like Anti Fog and Anti Scratch coating. Available in clear and smoked lens configurations, with the highest optical class. Packed in a Perspex box with hanging slot.

- Hard Coated lens – Longer life with unimpaired vision
- Anti Fog Coated – no steaming up of lens
- Lightweight wrap around – Comfortable and good coverage from all angles
- Optical rating 1 – No distortions / perfect clarity
- Including a neck cord
- Extremely flexible and durable
- Non-slip nose pads
- Conforms to EN 166
- Light weight 23g



Aristo[®] Clear UV

The clear lens is suitable when working indoors, providing general eye protection.

Aristo[®] Clear

0700 012 034



Aristo[®] Smoked UV

The smoked lens is suitable when working in strong ambient light.

Aristo[®] Smoked

0700 012 035



Spectacles, Goggles & Visors

Warrior™ Safety Spectacles

These stylish spectacles are used for drilling, chipping and metalworking. They have a sporty style, soft to the touch, and have a lightweight wrap around, including a neck cord. They are extremely flexible and durable, and are available in four different lens configurations. All lens configurations provide protection against dangerous UV radiation. CE approved according to EN 166-F. There are 12 pairs packed per box.

- Fantastically flexible and durable
- Rubberised sidepieces that hold spectacles in place
- Approved according to EN 166-F
- Scratch resistant lens of the highest optical class
- Anti-slip nose bridge
- Super lightweight—weighs only 24g
- Supplied with neck strap/lanyard
- Supplied in boxes of 12, individually packed and marked with part no., designation and barcode (EAN)



Warrior™ Clear

The clear lens is suitable when working indoors, providing general eye protection.

Warrior™ Clear Pk 12

0700 012 030



Warrior™ Smoked

The smoked lens is suitable when working in strong ambient light.

Warrior™ Smoked Pk 12

0700 012 031



Warrior™ Amber

The Amber (yellow lens) enhances the light. This is suitable when the ambient light is not sufficient.

Warrior™ Amber Pk 12

0700 012 032



Warrior™ Shade 5

The shade 5 spectacle provide protection not only against IR/UV light but also against the visible light during gas welding/cutting.

Warrior™ Shade 5 Pk 12

0700 012 033

Spectacles, Goggles & Visors

ESAB Eco Safety Spectacles

These stylish spectacles are used for drilling, chipping and metalworking, they have a sporty style and are extremely lightweight. Available in three different lens configurations. All lens configurations provide protection against dangerous UV radiation. CE approved according to EN 166-F. There are 10 pairs packed per box.



ESAB Eco Clear

The clear lens is suitable when working indoors, providing general eye protection.

ESAB Eco Clear Pk 12

0700 012 017



ESAB Eco Smoked

The smoked lens is suitable when working in strong ambient light.

ESAB Eco Smoked Pk 12

0700 012 018



ESAB Eco Amber

The Amber (yellow lens) enhances the light. This is suitable when the ambient light is not sufficient.

ESAB Eco Amber Pk 12

0700 012 019



Spectacles, Goggles & Visors

ESAB Safety Spectacles & Goggles



ESAB Visitor Spectacle

ESAB Visitor spectacle protects the eye from flying particles. The lenses are made of impact-resistant polycarbonate. The spectacles (frames & lenses) are certified to EN 166:2001.

ESAB Visitor Spectacle **0700 012 021**



ESAB Ski Goggle Clear

The special injected frame offers supreme user comfort as well as durability. Expanded Visual field. Cross Vent technology keeps air flowing in and moisture out. Moulded 2mm poly carbonate lens provides great impact protection.

ESAB Ski Goggle Clear **0700 012 027**



ESAB Ski Goggle Shade 5

The special injected frame offers supreme user comfort as well as durability. Expanded Visual field. Cross Vent technology keeps air flowing in and moisture out. Moulded 2mm poly carbonate lens provides great impact protection. These goggles meet ANSI Z87.1+ impact standard. ESAB Revolution UVIR Shade 5 is CE certified in addition to EN 169:2002 Optical Radiation (Welding).

ESAB Ski Goggle Shade 5 **0700 012 026**



ESAB Chemical Goggle

Provides protection against liquid splashes, dusts and spatter.

ESAB Chemical Goggle **0700 012 025**

Spectacles, Goggles & Visors

ESAB Safety Spectacles & Goggles



Grinding Visor Complete

A strong lightweight brown guard featuring an adjustable head harness and clear polycarbonate screen (200mm).

Grinding Visor Complete
Replacement Visor Clear Pk 5

0700 012 020
0700 012 023



ESAB Flip Front Goggle Round Shade 5

Protective goggle shade 5 for gas welding, brazing and gas cutting. The goggles are ventilated and have a flip-front mechanism. CE approved according EN 166/EN 175.

ESAB Flip Front Goggle, Shade 5

0700 012 022





Leather Workwear

ESAB's Leather protective range is helping to redefine welder protection, with garments that provide optimal fit, comfort, performance, style & durability, resulting in safer, more productive working environments.

The products include jackets, trousers, sleeves, aprons and gaiters, all ideal for every welding application for the professional welder.



ISO EN 11612
Flame Retardance



ISO EN 11611
level 1 and 2



Welding Jackets

The ESAB Proban/leather jackets are designed for maximum comfort and safety. The sleeves and shoulders are made in durable grade A leather to withstand the exposure to welding spatter. The front and back is made from flame retardant Proban material. The garment feature concealed inner pockets, adjustable sleeves and a stand up collar. Kevlar stitched.

ESAB Proban/Leather welding jacket, M, (45" chest)	0700 010 301
ESAB Proban/Leather welding jacket, L, (47" chest)	0700 010 302
ESAB Proban/Leather welding jacket, XL, (48" chest)	0700 010 303
ESAB Proban/Leather welding jacket, XXL, (50" chest)	0700 010 304
ESAB Proban/Leather welding jacket, 3XL, (52" chest)	0700 010 386
ESAB Proban/Leather welding jacket, 4XL, (54" chest)	0700 010 387



Welding Trousers

The ESAB Proban/Leather trousers are designed for maximum comfort and safety. The front of the legs are reinforced with leather to withstand the spatter and welding sparks. Kevlar stitched.

ESAB Proban/Leather welding trousers, M, (33")	0700 010 333
ESAB Proban/Leather welding trousers, L, (37")	0700 010 334
ESAB Proban/Leather welding trousers, XL, (39")	0700 010 335
ESAB Proban/Leather welding trousers, XXL, (41")	0700 010 336



Welding Jacket Combination

The front of welding jacket Combi is made of leather to give the best protection against heat and welding spatter. To reduce the weight of the garment the back is made of Proban material. The standing collar gives protection against welding spatter. Adjustable cuffs.

Welding jacket Combi, size M, (45" chest)	0700 010 271
Welding jacket Combi, size L, (47" chest)	0700 010 272
Welding jacket Combi, size XL, (48" chest)	0700 010 273
Welding jacket Combi, size XXL, (50" chest)	0700 010 274



Welding Jacket

ESAB Welding jackets are made of high quality leather. The front is reinforced in order to withstand mechanical and thermal stress. The jacket is stitched with Kevlar thread, features stand up collar and inside pocket with adjustable wrists.

Welding Jacket M, (45" chest)	0700 010 266
Welding Jacket L, (47" chest)	0700 010 002
Welding Jacket XL, (48" chest)	0700 010 003
Welding Jacket XXL, (50" chest)	0700 010 267



Welding Aprons

The ESAB protective aprons distribute the weight effectively. They are Kevlar stitched and 107cm long.

ESAB Apron	0700 010 007
------------	---------------------



Leather Gaiters

Leather gaiters to protect the footwear during welding. The gaiters are fastened using velcro.

Leather Gaiters (sold as a pair)	0700 010 008
----------------------------------	---------------------



Welding Sleeve

Chrome leather sleeves with a total length of 47cm. Equipped with elasticated cuff and velcro arm fastening.

Welding Sleeve Pk 2	0000 595 039
---------------------	---------------------



Clothing and Workwear



Whatever your welding clothing requirements, ESAB can offer you a high performance range of welding garments suitable for any welding environment. With a great choice of traditional leather or high specification, Phoenix FR[®] inherently flame retardant fabrics, ESAB's product experts have developed a superior range of multi-risk garments to meet the demands of the welder.

Phoenix FR[®]

ESAB is proud to introduce the very latest technology in inherent flame retardant garments. In many industries workers face a complex mix of safety hazards, yet most protective fabrics protect from one or two hazards only. For this reason, employers in the past have been forced to compromise on safety. Not any more.



Phoenix FR[®] is proven to protect from flame, weld spatter, heat and electric arc explosion. Its' unique molecular structure means that the flame-resistant properties are inherent and therefore, permanent. This technology is the result of a four year development programme and ensures that all our Phoenix FR[®] range exceed the very latest ISO international standards.



EN ISO 11612:2008 (A1, B1 and C1)
Protective clothing against heat



EN 1149-5:2008
EN 1149-3:2004
Electrostatic properties



EN ISO 11611:2007 (class 1 A1)
Protective clothing for welding



EN 340
Protective clothing general lining

Welding Clothing/Flame Resistant



Welding Jacket FR

The ESAB Black & yellow Welders Jacket has been designed to give maximum performance, yet offer extreme comfort & durability. The Garment is made from high performance Phoenix-FR fabric which is inherently flame retardant. The coverall features adjustable sleeves, two top pockets and concealed Zip front. This garment is fully CE approved to EN ISO11612 FR, ISO 11611 Welding, EN1149-5 Anti Static & EN61488 Arc protection. Sizes Small to XX-Large.

ESAB FR Welding Jacket, S, (38" chest)	0700 010 358
ESAB FR Welding Jacket, M, (40" chest)	0700 010 359
ESAB FR Welding Jacket, L, (42" chest)	0700 010 360
ESAB FR Welding Jacket, XL, (44" chest)	0700 010 361
ESAB FR Welding Jacket, XXL, (46" chest)	0700 010 362



FR Welding Trousers

The ESAB Black & Yellow Welders trousers has been designed to give maximum performance, yet offer extreme comfort & durability and compliment the FR welding Jacket. The Garment is made from high performance Phoenix-FR fabric which is inherently flame retardant. The trousers features elasticated waist with Belt loops, two side access pockets and two back pockets. This garment is fully CE approved to EN ISO11612 FR, ISO 11611 Welding, EN1149-5 Anti Static & EN61488 Arc protection. Sizes Small to XX-Large.

ESAB FR Welding Trousers, S, (30" waist)	0700 010 363
ESAB FR Welding Trousers, M, (32" waist)	0700 010 364
ESAB FR Welding Trousers, L, (34" waist)	0700 010 365
ESAB FR Welding Trousers, XL, (36" waist)	0700 010 366
ESAB FR Welding Trousers, XXL, (38" waist)	0700 010 367
ESAB Overall Knee Pads	0700 010 352



ESAB FR Coverall

The ESAB Black and Yellow coverall has been designed to give the welder maximum protection and comfort. Material inherently flame retardant. The coverall features an elasticated waist for better comfort and fit, adjustable sleeves and legs, and a covered/protected zipper. The neck is protected by the stand up collar and knee pads can be fitted.

ESAB welders coverall, size S, (38" chest)	0700 010 328
ESAB welders coverall, size M, (40" chest)	0700 010 329
ESAB welders coverall, size L, (42" chest)	0700 010 330
ESAB welders coverall, size XL, (44" chest)	0700 010 331
ESAB welders coverall, size XXL, (46" chest)	0700 010 332



ESAB Overall Knee Pads

ESAB Overall optional knee pads.

ESAB Overall Knee Pads (Pack of 2)	0700 010 352
------------------------------------	---------------------



Welding Coveralls (Flame Retardant)

The ESAB navy fire retardant 100% cotton coverall comes with 2 chest pockets a ruler pocket and has concealed stud fastenings. Conforms to EN 531, EN 470-1 & EN 533.

ESAB Proban coverall, M (40" chest)	0700 010 038
ESAB Proban coverall, L (42" chest)	0700 010 039
ESAB Proban coverall, XL (44" chest)	0700 010 040
ESAB Proban coverall, XXL (46" chest)	0700 010 041

Welding Clothing/Flame Resistant



ESAB FR Fleece

ESAB Phoenix-FR Black Flame retardant, anti-static, welders Fleece. Featuring, Zip front with contrasting plackett, two side pockets and one internal zip. Conforms to EN ISO11612 FR, ISO11611 Welding, EN1149-5 Anti Static. Sizes Small to XX-Large.

ESAB FR Fleece, S, (42" chest)	0700 010 368
ESAB FR Fleece, M, (44" chest)	0700 010 369
ESAB FR Fleece, L, (46" chest)	0700 010 370
ESAB FR Fleece, XL, (48" chest)	0700 010 371
ESAB FR Fleece, XXL, (50" chest)	0700 010 372



ESAB FR Jersey / Under shirt

ESAB Phoenix-FR Black Flame retardant, anti static, welders Jersey polo Shirt. Featuring, Zip front with contrasting plackett, Unique ESAB Contrasting ribbed collar. Conforms to EN ISO11612 FR, ISO11611 Welding, EN1149-5 Anti Static. Sizes Small to XX-Large.

ESAB FR Jersey, S, (30" chest)	0700 010 373
ESAB FR Jersey, M, (40" chest)	0700 010 374
ESAB FR Jersey, L, (42" chest)	0700 010 375
ESAB FR Jersey, XL, (44" chest)	0700 010 376
ESAB FR Jersey, XXL, (46" chest)	0700 010 377



ESAB FR Jumper

ESAB Phoenix-FR Flame retardant, anti static, welders Jumper. Conforms to EN ISO11612 FR, ISO11611 Welding, EN1149-5 and is Anti Static. Sizes Small to XX-Large.

ESAB FR Jumper, S, (30" chest)	0700 010 378
ESAB FR Jumper, M, (40" chest)	0700 010 379
ESAB FR Jumper, L, (42" chest)	0700 010 380
ESAB FR Jumper, XL, (44" chest)	0700 010 381
ESAB FR Jumper, XXL, (46" chest)	0700 010 382

Head Protection



Proban Hood

Flame resistant head protection which cover not only the head but also the neck, nape and shoulders.

Proban Hood **0000 593 269**



Balaclava

The balaclava is worn underneath the welding helmet to give you full head protection when working in a cold environment. The balaclava is flame resistant, 100% zirpro treated wool, 385 gr/m² EN531.

Balaclava **0700 010 269**



Helmet Liner

The insulated helmet liner is worn underneath the welding helmet to offer protection from the elements when working in a cold environment.

Insulated Helmet Liner **0000 904 378**

Welding Gloves

Glove EN Standards and Materials

CE labelling – Risk Class – Categorising Personal Protective Equipment (PPE), EU Directive 89/686/EF.

The intention of this directive is to ensure that all PPE sold in Europe corresponds to the relevant EN standards. This will secure a generally identical quality standard throughout Europe. Products that meet the requirements in one or more standards must be branded with the CE logo.

Category 1, Simple Design:

These products protect against minimal risks and can only be used where any risk increases gradually and can be easily identified by the user in advance. The CE labelling consists of only the CE mark.

Category 2, Intermediate Design:

The products are tested and technically approved by an authorised test institute. The institute also examines the manufacturers technical documentation to establish that the product is produced in accordance with the relevant EN standard. The CE labelling consists of the CE mark, the test institute approval number, year of first time approval, pictograms and test performance.



EN 388:2003 – Protection against mechanical damage

- a) Abrasion resistance
- b) Blade Cut resistance
- c) Tear resistance
- d) Puncture resistance

Character

- 1 – 4
- 1 – 5
- 1 – 4
- 1 – 4



EN 407:2004 – Welding gloves Thermal resistance

- a) Burning behaviour
- b) Contact heat
- c) Convective heat
- d) Small splashes of molten metal
- f) Large splashes of molten metals

Character

- 1 – 4
- 1 – 4
- 1 – 4
- 1 – 4
- 1 – 4



EN 420 – general requirements for most protective gloves as

- Product and packaging information and labelling
- Care and maintenance
- Size
- The product itself must present no risk to users (requirements concerning chromium content and pH)
- Storage of the products

Welding Gloves

Glove EN Standards and Materials

Test Criteria achievable	Standard	Minimum performance required		Maximum performance
		A	B	
Abrasion resistance	EN 388	2	1	4
Blade cut resistance	EN 388	1	1	5
Tear resistance	EN 388	2	1	4
Puncture resistance	EN 388	2	1	4
Burning behaviour	EN 407	3	2	4
Contact heat	EN 407	1	1	4
Convective heat	EN 407	2	n/a	4
Small splashes of molten metal	EN 407	3	2	4
Dexterity	EN 420	1	4	5

Sizing of gloves	XS	S	M	L	XL	XXL
Size	6	7	8	9	10	11

Leather quality

Finding the right quality leather to meet the exacting requirements of the welding professional requires experience. ESAB have extensive knowledge and experience with tanning and finishing – important processes that determine the final quality of the leather. It is these processes that give the leather its qualities in relation to strength, softness and flexibility.

The upper skin is called “grain” and the inner skin is called “split” Grain leather is soft, durable, wear resistant and tolerates some water. It can also withstand heat up to 80°C. Split leather is porous and will therefore absorb humidity more easily than grain leather. Its naturally rough surface gives good grip properties. The thickness depends on how the skin is cut and whether it is cut in one or two layers. Without special treatment, split leather can resist heat up to 100°C.

Ox Leather

A wear resistant grain leather which tolerates water. The leather is often thick, which in addition to its wear resistant properties makes it suitable for use in working gloves that must tolerate rough use. It also gives good protection against heat.

Pig Leather

The surface of the leather is relatively porous which makes the breathability of the glove better than most other leathers. Pig leather is also softer.

Goat Leather

Goat leather is the longest lasting leather. Natural lanolin content makes goat leather extremely flexible. It also has very good wear resistance. Strength and flexibility make this leather very suitable for work where good finger feel and dexterity is required.

Welding Gloves

MIG/MAG/MMA

All ESAB gloves are CE approved. The heavy duty welding gauntlets and riggers have been tested and certified by a third party notifying body. The glove is then a Cat 2 product.



Test against mechanical stress such as abrasion, cut, tear and puncture.



Test for thermal performance such as exposure to an open flame, contact heat, convective heat, radiant heat, small and large splashes of molten metal.



ESAB Curved MIG Glove

These superior new welding gloves from ESAB offer a whole new approach to fit, form and function. Ergonomically designed to fit the natural curve of the hand, offering increased quality & comfort to the wearer. The MIG glove is made from heavy & fine cut leather, and is lined from hand to cuff. With the curved design the glove fits the hand perfectly, and also has a flexible wrist area which reduces friction. With welted seams, kevlar stitching & reinforced thumb, the glove is very strong and offers a very high level of protection to the wearer. EN 12477 and EN 388 Cat 2.

ESAB Curved MIG, M	0700 005 038
ESAB Curved MIG, L	0700 005 043
ESAB Curved MIG, XL	0700 005 040
ESAB Curved MIG, XXL	0700 005 039



Heavy Duty Basic

A high quality 1.2/1.3mm thick side split cow leather welding gauntlet with Wing thumb, fully Kevlar stitching, fully welted. The glove is fully lined with FR cotton to cuff and full fleece jersey liner to palm. This glove offers the welder durability, longevity and total comfort. CE approved to EN12477 and EN388 Cat 2.

Heavy Duty Basic, L	0700 005 007
---------------------	---------------------



Welding Gloves

MIG/MAG/MMA



Heavy Duty Regular

A Heavy duty durable yet flexible welding gauntlet. Made from 1.3mm side split cow leather which is fully heat resistant and hard wearing. Features reinforced thumb, fully Kevlar stitched and welted with additional vein patch for added protection. The glove is fully lined with FR cotton to the cuff and fleece jersey liner to the palm. CE approved to EN12477 and EN388 Cat 2.

Heavy Duty Regular

0700 005 008



Heavy Duty Black

Our most popular product, made from high performance cow split leather, high dexterity palm and fingers with wing thumb, fully welted fingers and Kevlar stitched. Ideal for areas of high mechanical stress. CE approved to EN12477 and EN388 Cat 2.

Heavy Duty Black, L

0467 222 007



Heavy Duty EXL

A high quality welding gauntlet made from both cow split and grain leather. The grain leather back offers excellent heat properties while the split leather offers excellent dexterity, durability and comfort. Features fully reinforced three fold thumb, fully welted, Kevlar stitched with grain back. Fully lined inner with FR cotton to cuff and full jersey lining to palm. CE approved to EN12477 & EN388 Cat 2.

Heavy Duty EXL, L

0700 005 009

Heavy Duty EXL, XL

0700 005 029



Red Gauntlet

ESAB's entry level welders gauntlet, made from cow split leather with a cotton FR lining. Fully welted with a wing thumb for added comfort. CE approved to EN12477 & EN388.

Red Gauntlet, L

0701 380 498

Welding Gloves

Welding Gloves TIG



ESAB Curved TIG Gauntlet

These superior new welding gloves from ESAB offer a whole new approach to fit, form and function. Ergonomically designed to fit the natural curve of the hand, offering increased quality & comfort to the wearer. The TIG glove is made from thin high quality leather, with improved fit for higher dexterity. The glove is highly durable, with welted seams & kevlar stitching. The glove is also extremely light weight, which increases the comfort to the wearer.

ESAB Curved TIG Gauntlet, M	0700 005 036
ESAB Curved TIG Gauntlet, L	0700 005 041
ESAB Curved TIG Gauntlet, XL	0700 005 042
ESAB Curved TIG Gauntlet, XXL	0700 005 037



TIG Basic

A lightweight durable traditional Tig welders gauntlet upgraded to EN12477 & EN388 Cat 2.

TIG Basic, L	0700 653 532
--------------	---------------------



TIG Soft

A unique ultra thin Goat split leather welding glove, suitable for all Tig applications. Features a reinforced straight thumb, wraparound first finger, vein patch and 13cm extended cuff. CE approved to EN12477 & EN388 Cat 2.

TIG Soft	0700 005 005
----------	---------------------



Welding Gloves

Welding Gloves TIG



TIG SuperSoft

ESAB exclusive Tig welding gauntlet made from high quality sheepskin with full Kevlar stitching. Features gun cut straight thumb, cow split 13cm cuff, wraparound 1st finger for increased dexterity, extremely comfortable, dexterous and durable. CE approved to EN12477 & EN388 Cat 2.

TIG SuperSoft, L

0700 005 006



TIG Professional

A high quality Tig gauntlet made from selected cow hide, features wing thumb with reinforcement, 13cm split leather cuff, vein patch and with the addition of a jersey lightweight liner to the palm. CE approved to EN12477 & EN388 Cat 2.

TIG Professional, L

0701 415 963

Welding Gloves General Handling



ESAB Heavy Duty Worker

A durable, hardwearing rigger style work glove made from high quality cow side split leather, featuring wing thumb, fully welted seams, vein patch, 6cm rubberised cotton cuff with finger tip protection and knuckle strap. Fully jersey lined for added comfort. CE approved to EN388 Cat 2.

Heavy Duty Worker

0700 005 011

Welding Gloves

Welding Gloves Heat Resistant



Aluminised Hand Shield

Woven Kevlar Aluminised Welders hand shield for use in conjunction with welding gauntlets, to give added protection from radiant heat and general heat stress. Aluminised Kevlar is bonded and Stitched onto a 1.2mm cow split leather which is elasticated to fit all hand sizes.

Aluminised Hand Shield

0700 010 009



Heavy Duty Aluminium 250°C

A high temperature addition to the range. Featuring unique aluminised woven Kevlar back capable of withstanding a radiant heat of up to 1000°C with a heavy duty 1.3mm ceramic fibre supported leather palm capable of Contact palm heat up to 250°C. The glove features wing thumb, fully welted seams, Kevlar stitched with a heavy duty FR drill cotton liner which features a Thermolate treatment to the palm. The aluminium reflects all thermal radiation away from the user. CE approved to EN12477 & EN388 Cat 2.

Heavy Duty Aluminium 250°C, L

0700 005 010



Heavy Duty Aluminium 500°C

An ultra high temperature 500°C welding gauntlet featuring: unique aluminised woven Kevlar back capable of withstanding 1000°C, with a heavy duty 1.3mm ceramic fibre supported leather palm capable of Contact heat up to 500°C. The glove features wing thumb, fully welted seams, full Kevlar stitching with a heavy duty cotton jersey liner which features a shearwater treatment to the palm. The aluminium reflects all thermal radiation away from the user. CE approved to EN12477 & EN388 Cat 2.

Heavy Duty Aluminium 500°C, L

0700 005 046



Heavy Duty Aluminium 1500°C

A revolutionary new product which incorporates high technology woven ceramic fibre to the back of the Aluminised Kevlar Gauntlet, which offers protection against 1500°C radiant heat. This is incorporated into a high grade 1.3mm side split leather palm with full Thermolate felt offering 120°C contact heat protection to the palm. The glove is fully lined with jersey palm, offers a wing thumb, fully welted stitching and full Kevlar stitching. CE approved to EN12477 & EN388 Cat 2.

Heavy Duty Aluminium 1500°C, L

0700 005 045





Safety Footwear

Premium Welding Safety Footwear

ESAB safety shoes and boots are specially developed for the welder. Made of leather to give the best durability against welding spatter and heat. The tongue is designed to prevent welding sparks entering the shoe. If this should still happen, the shoes can be quickly removed because there are no laces. All ESAB Safety shoes for welding are approved according to EN 345 to the highest protection class S3.

Key to safety classes and symbols:

- SB** Safety class Basic according to EN 345 (Lowest protection class, not recommended by ESAB)
- S1** Safety class 1 (Antistatic properties and energy absorbent heel) according to EN 345
- S2** Safety class 2 (Antistatic properties, energy absorbent heel and water repellent upper)
- S3** Safety class 3 (Antistatic properties, energy absorbent heel, water repellent upper, toecap and sole puncture protection) according to EN 345
-  Antistatic properties
- DD** The double density means that the inner sole is made of an advanced impact absorbent material with reinforced arch. The outer sole is made of a non-slip material
-  Toe cap and sole puncture protection



ESAB Welding Safety Boot



The ESAB black welding safety boot with external welding sparks protection guard ideal for spark and spatter environments. Offers toe and midsole protection conforming to safety workplace standards, with water-resistant upper and antistatic, heel heat absorption and an energy absorbing rubber sole. Quick release pin for additional safety.

Features

- Toe protection tested to 200j impact
- Heat resistance rubber sole (300° / 60 seconds)
- Antistatic
- Welding sparks protection cove
- Water resistance upper leather

Welders Ankle Boot, size 5 (39)	0700 010 417
Welders Ankle Boot, size 6 (40)	0700 010 418
Welders Ankle Boot, size 7 (41)	0700 010 419
Welders Ankle Boot, size 8 (42)	0700 010 420
Welders Ankle Boot, size 9 (43)	0700 010 421
Welders Ankle Boot, size 10 (44)	0700 010 422
Welders Ankle Boot, size 11 (45)	0700 010 423
Welders Ankle Boot, size 12 (46)	0700 010 424



TM-200 PM-300 TM-80

CarryVac 2 Portable Smoke Extractor

The CarryVac 2 P150/P150 AST are two small, lightweight, portable extraction units designed to be carried to the working area. Connected to a welding torch or to an extraction nozzle, the CarryVac 2 units extract the fume directly at source. The polluted air is filtered and captured in a hygienically-packed filter. The CarryVac 2 is equipped with a filter indicator, which shows when the filter must be replaced. It is ideal for maintenance welding, low and medium-duty cycle. The filter capacity is approximately 200kg of solid wire or twelve 15kg spools. The CarryVac 2 P150 AST is equipped with an automatic start/stop function, which increases the service life of each filter and of the unit itself. Please also see ESAB Centrovac extraction torch range.

Delivery contents:

Supplied complete with 2.5m suction hose (Filter Included).

CarryVac 2 P150 220-240V	0700 003 883
CarryVac 2 P150 AST 220-240V	0700 003 884
CarryVac 2 110V	0700 003 885
CarryVac 2 AST 110V	0700 003 886
Hose 45mm, 1.6m	0154 352 015
Hose 45mm, 5m	0700 003 224
Hose 45mm, 15m	0700 003 225
Suction nozzle TM-80, round 80mm	0700 003 221
Suction nozzle TM-200, 200mm wide	0700 003 222
Suction nozzle PM-300, 300mm wide	0700 003 223
Magnet for suction nozzle	0332 010 880
Main filter CarryVac 2	0700 003 004
Pre filter	0468 455 002
Main filter CarryVac (previous model)	0468 455 001

Technical data

Length.....	810mm
Width	226mm
Height	410mm
Weight incl. filter.....	16kg
Mains power supply	230/1~
Output.....	1000 W
Noise level.....	75 dB (A)
Max vacuum	2170mm wp
Filter area	5.3m ²
Air flow (with 2.5m suction hose).....	150m ³ /h
Suction hose diameter	Ø45mm
Filter efficiency.....	99.7%



DNV BUSINESS ASSURANCE

MANAGEMENT SYSTEM CERTIFICATE

Certificate No. 106973-2011-AQ-SWE-SWEDAC / 2006-SKM-AE-1093 / 2008-SKM-AHSO-143

This is to certify that

ESAB GROUP

WORLDWIDE

has been found to conform to the Management System Standards:

ISO 9001:2008, ISO 14001:2004, OHSAS 18001:2007

This Certificate is valid for:

Management, development, design, purchase, production, warehousing, sales, services and supply of welding and cutting products

Initial Certification date:
2006-01-22 (14001)
2008-11-01 (18001)
2012-04-18 (9001)

This Certificate is valid until:
2017-01-31 (9001)
2015-01-31 (14001)
2017-01-31 (18001)

Place and date:

Stockholm, 2014-01-23



for the Accredited Unit:
DNV CERTIFICATION AB,
SWEDEN

*The audit has been performed
under the supervision of:*

Henrik Bäckman
Lead Auditor

Ann-Louise Pätt
Management Representative

Lack of fulfilment of conditions as set out in the Certification Agreement may render this Certificate invalid.

ACCREDITED UNIT: DNV CERTIFICATION AB, BOX 6046, SOLNA, SWEDEN, TEL: +46 (0) 8 587 940 00, WWW.DNVIA.SE / WWW.DNVBA.COM

UNRIVALLED SERVICE AND SUPPORT

Every ESAB product is backed by our commitment to superior customer service and support. Our skilled customer service department is prepared to quickly answer any questions, address problems, and help with maintenance and upgrading of your equipment. Our products are backed with the most comprehensive warranty in the business.

With ESAB, you can be sure that you purchased equipment that will meet your needs today and in the future. Ask your ESAB sales representative or distributor for a complete ESAB solution.

For more information, visit www.esab.com



XA00175020 / 2015/02 ESAB reserves the right to alter specifications without prior notice



ESAB / esab.com

COMPANY WITH
MANAGEMENT SYSTEM
CERTIFIED BY DNV

= ISO 9001 =
= ISO 14001 =
= OHSAS 18001 =