



SERIES ARC300



Series ARC300

CE
LVD 2006/95/EC valid until April 19th 2016
LVD 2014/35/EU valid from April 20th 2016
EMC 2004/108/EC valid until April 19th 2016
EMC 2014/30/EU valid from April 20th 2016
RoHS 2011/65/EU

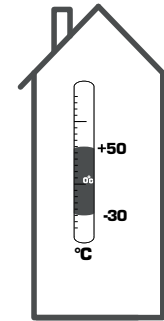

Mtrl.nr. 9814 09 56 • Ritn.nr 8467 vers. A • Rev 1512



ARC300
Valve
Assembly
ARC300
Damper
Assembly

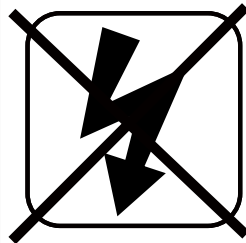

ARC361/ARC363

E 2A

2-point

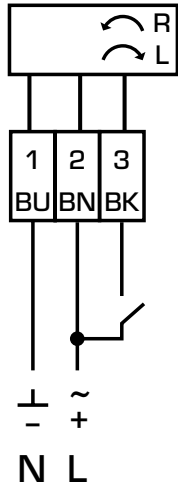

3-point

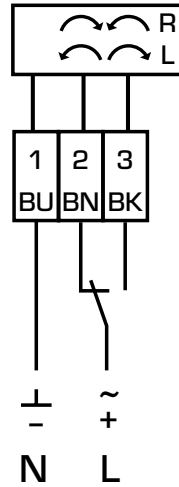

i

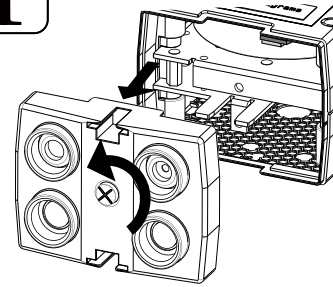

ARC361=85...265V AC/DC

ARC363=19...29V AC/DC

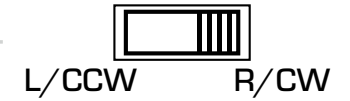
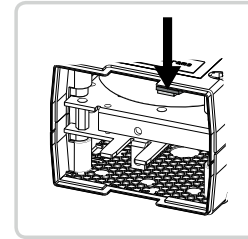

R/CW=Clockwise working direction
L/CCW=Counter clockwise working direction

ARC368/ARC369

E 2B

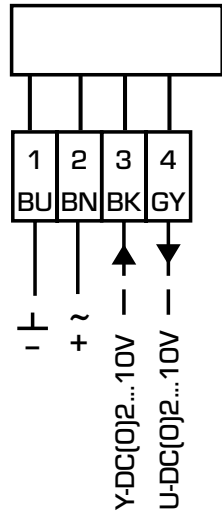

AC 19...29 V
DC 19...29 V

Y-DC(0)2...10V
U-DC(0)2...10V

i

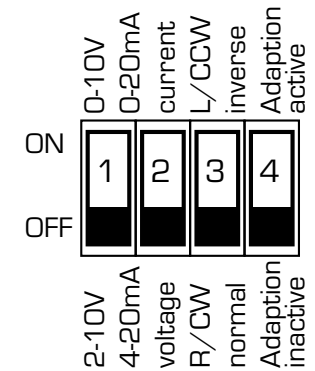
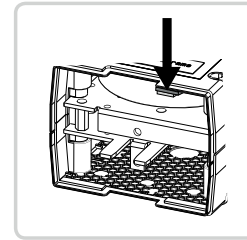
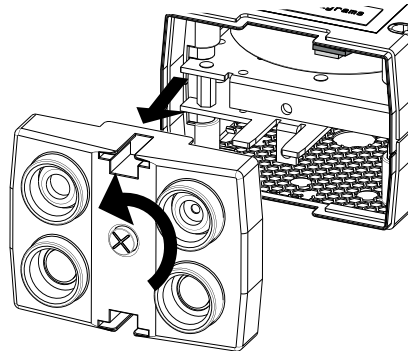

R/CW=Clockwise working direction
L/CCW=Counter clockwise working direction

ARC368/ARC369

E 3

Y=0 - 10 V DC/0-20mA

U = 0-10 V DC

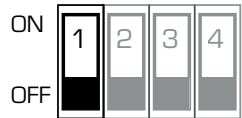

Y = 2 - 10 V DC/4-20mA



U = 2 - 10 V DC

Current (mA)

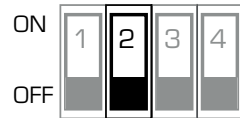

Voltage (V DC)

L/CCW

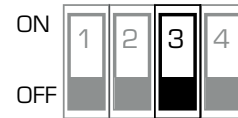

R/CW



Adaption active

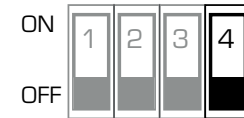

Adaption inactive

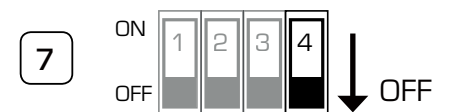
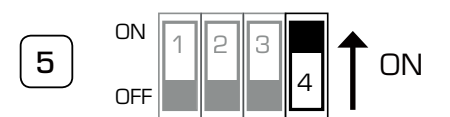

ARC368 Auxiliary switch S1/S2

E 4a

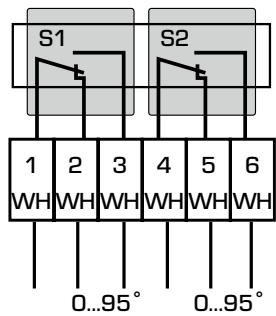

i

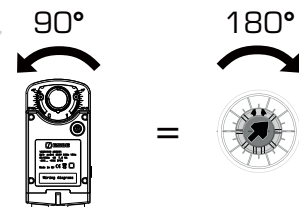
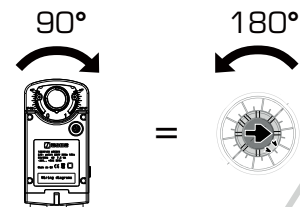
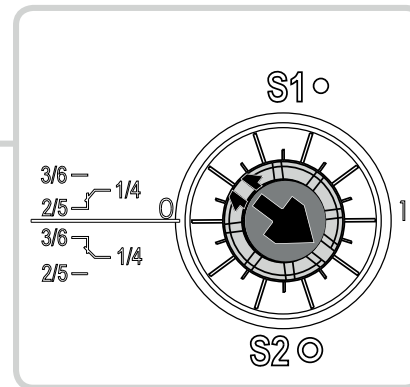
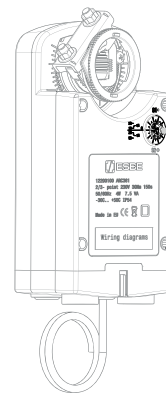

S1

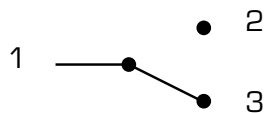
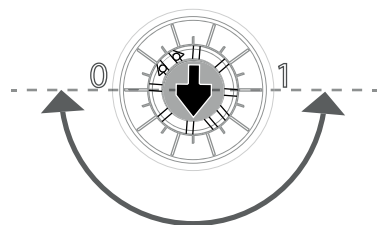
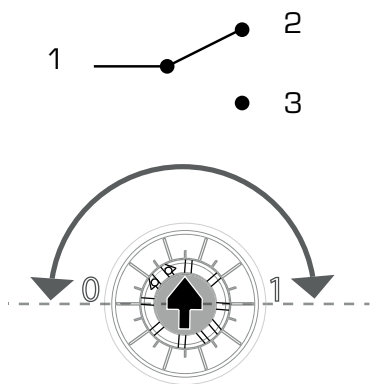

S2

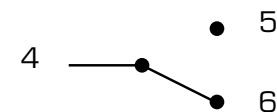
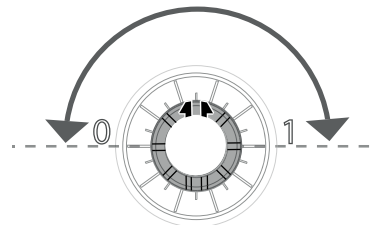
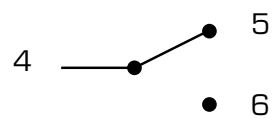

Example R/CW operation

Example L/CCW operation

E 4b

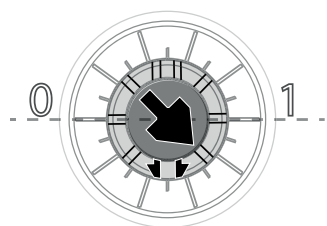

= 0° (Closed position)

Ex. **S1** 0° - 20° 1 — 3
 20° - 90° 1 — 2

Ex. **S2** 0° - 45° 4 — 6
 45° - 90° 4 — 5

E 4c

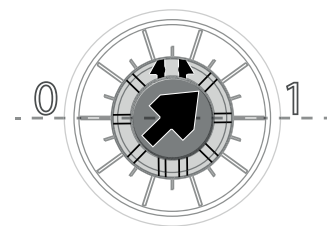

= 0° (Closed position)

Ex. **S1** 0° - 20° 1 — 2
 20° - 90° 1 — 3

Ex. **S2** 0° - 45° 4 — 5
 45° - 90° 4 — 6

All examples are general representations