

1 Material composition

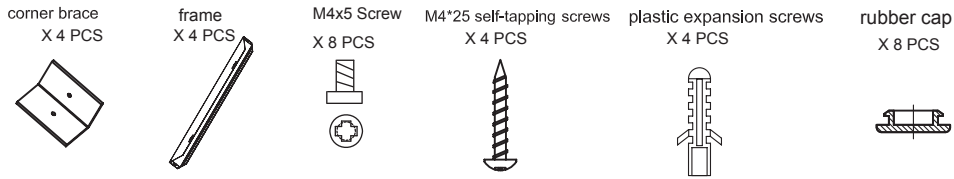

2 Assemble the parts as below frame with screw driver

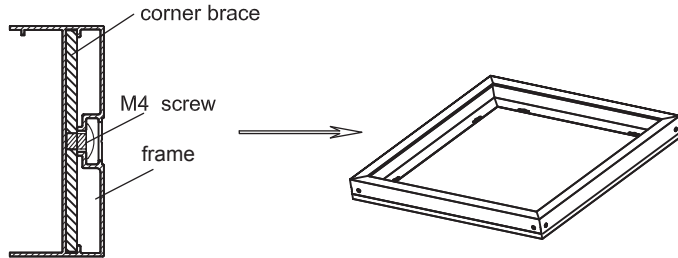

3 Mark position details as below

Frame Type	L*W(mm) Mounting Dimensions
IM-600x600	350*531.5

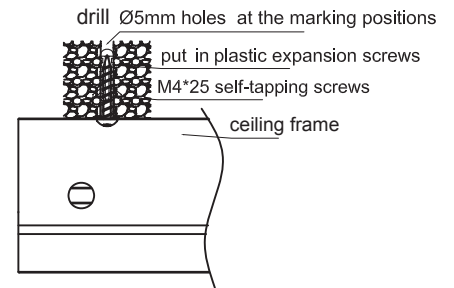
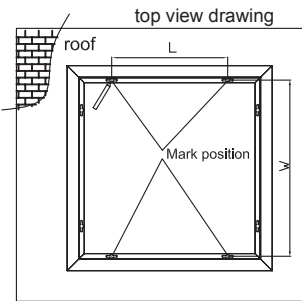

4 Install the frame on the roof, then open the frame on one side

move the ceiling frame then screw

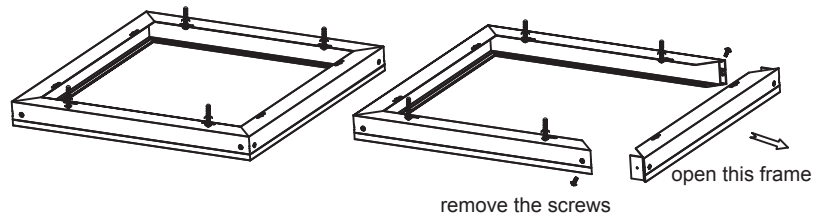
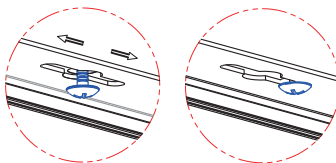

5 Put the panel into the frame, then seal the frame.

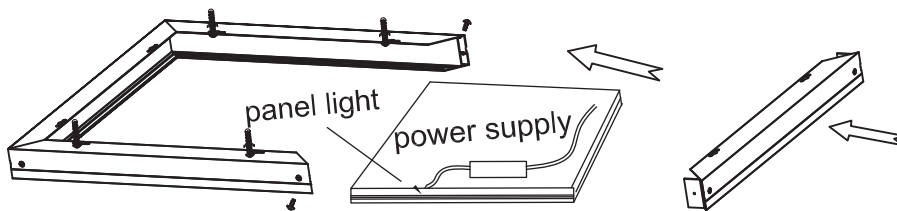

6 Seal the hole with rubber cap, finished top view drawing (right)

