







Ravaglioli

COMPANY WITH
QUALITY SYSTEM
CERTIFIED BY DNV GL
= ISO 9001 =

DUE COLONNE ELETTROIDRAULICI 
ELECTRO-HYDRAULIC 2 POST LIFTS 
ELEKTROHYDRAULISCHE 2-SÄULEN HEBEBÜHNEN 
2 COLONNES ELECTRO-HYDRAULIQUES 
DOS COLUMNAS ELECTRO-HYDRAULICOS 



*For long wheel-base
vehicles 5500 kg
7000 kg*

KPH370.55LIKT / 5500 kg
KPH370.70LIKT / 7000 kg

Modello equipaggiato con **4 bracci extra lunghi a tre stadi**: ideali per il sollevamento di furgoni e furgonati a passo lungo incluso Mercedes Sprinter e VW Crafter.

Model equipped with **four extra long three-stage arms**: ideal to lift long wheel-base vans like Mercedes Sprinter and VW Crafter.

Modell mit **vier zweifach ausziehbaren extra langen Armen** ausgestattet: ideal zum Heben von Lieferwagen auch mit langem Radstand wie Mercedes Sprinter and VW Crafter.

Élévateur équipé de **quatre bras extra longs à 3 étages**: idéal pour le levage de fourgons à châssis long inclus les Mercedes Sprinter and VW Crafter.

Modelo equipado con **4 brazos extra largos de tres extensiones**: ideal sea para el levantamiento de furgonetas normales y de chasis largo incluido Mercedes Sprinter and VW Crafter.

KPH370.55LIKTA / 5500 kg
KPH370.70LIKTA / 7000 kg

Versioni con due bracci lunghi a 3 stadi e due a 4 stadi, consentono caricabilità ottimale anche per le autovetture.

Models equipped with **two long 3-stage arms and two long 4-stage arms**, to allow easy lifting of large cars.

Ausführungen mit **zwei zweifach und zwei dreifach ausziehbaren langer Armen**, um eine optimale Aufnahme von PKWs auch zu garantieren.

Versioni équipées de deux bras longs à 3 étages et deux à 4 étages pour garantir aussi le levage optimal de voitures.

Versiones con dos brazos largos de 3 extensiones y dos de 4 extensiones, por el levantamiento tambien de turismos.

Dispositivo di appoggio meccanico ad inserimento automatico a garanzia della massima sicurezza in fase di stazionamento.

Mechanical safety latch with automatic engagement ensuring maximum safety when lift is in standing position.

Mechanische Stützvorrichtung mit automatischer Einschaltung um eine maximale Sicherheit im aufgehobenen Zustand zu garantieren.

Dispositif de soutien mécanique avec enclenchement automatique pour garantir la sécurité totale pendant le stationnement.

Dispositivo de apoyo mecánico de funcionamiento automático como garantía de la máxima seguridad en la fase de estacionamiento.

I cavi non portanti garantiscono la sincronizzazione.

Synchronization cables grant the levelling of the two carriages.

Gleichlauf mittels Seile (nicht tragend).

La synchronisation est garantie grace à un cable d'acier non-portant.

Los cables no portantes garantizan la sincronización.

In ciascuna colonna è presente un pistone di sollevamento che non richiede alcuna manutenzione.

Each column features a maintenance-free lifting cylinder.

Wartungsfreie Zylinder in jeder Säule.

Chaque colonne est équipée d'un vérin conçu pour un fonctionnement "sans entretien."

En cada columna está presente un pistón de elevación que no requiere mantenimiento alguno.



SINCE 1958

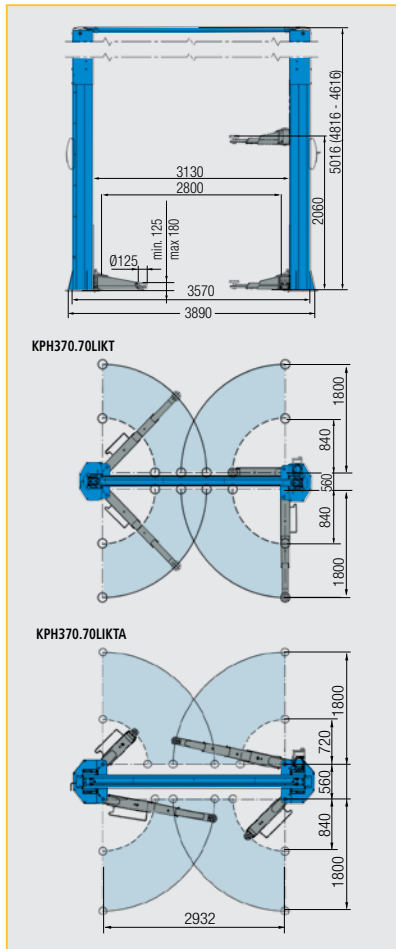
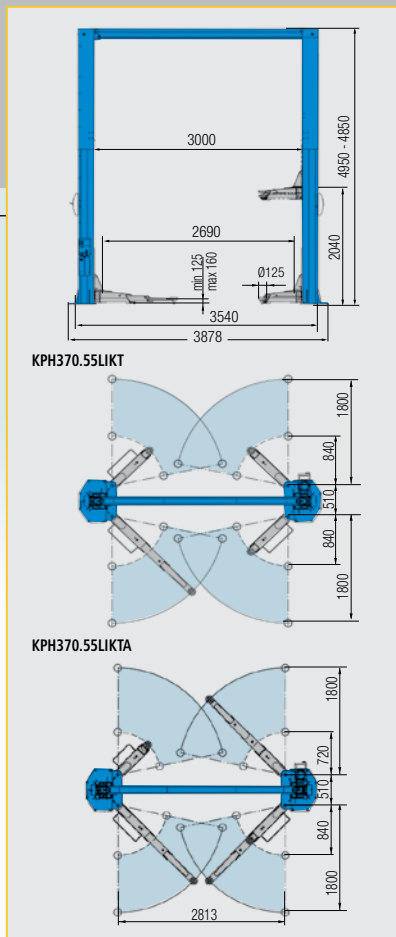

Altezza regolabile
Adjustable height
Justierbare Höhe
Hauteur réglable
Altura reglable

KPH370.55LIKT/LIKTA
4950 mm
4850 mm

KPH370.70LIKT/LIKTA
5016 mm
4816 mm
4616 mm

VARKPH370.55LIKT/T - VARKPH370.70LIK/T

Versione a richiesta con:	Version on demand featuring:	Version auf Anfrage:	Version sur demande avec:	Versión bajo pedido con:
1 Comando singolo per salita/discesa	Single lifting/lowering control	Drehwendschalter zum Hoch-und Runterfahren	Commande unique pour montée-descente	Mando individual para bajada/subida
2 Sgancio arresti pneumatico	Pneumatic release of locking devices	Pneumatische Entriegelung	Décrochage pneumatique des arrêts	Desenganche neumático de los trinquetes de seguridad
3 Centralina in alto	Control unit on the upper part of the column	Hydraulikaggregat oben	Unité hydraulique en haut	Centralita posicionada en la parte alta de la columna

OPTIONS

KPH370.55LIKT	S224A3		S370A19	S370A17
KPH370.70LIKT	S370A7 (H=80mm)	4x	S370A16	S370A14
	S224A4			
	S370A8 (H=140mm)	4x		
	S370A18			
	S370A15 (H=200mm)	4x		
		For Fiat Ducato, Peugeot Boxer, Citroën Jumper	Supporti presa telaio Frame adapters Distanziali Halierungen für Chassisaufnahme Spacers Abstandstücke Rehausses Espesores	For Mercedes Sprinter, VW LT+Crafter Supporti Adapters Halierungen Supports Adaptadores de agarre



Ravaglioli S.p.A.
via 1° maggio 3
Fraz. Pontecchio M.
40037 Sasso Marconi (Bo) - Italia
Tel. +39 - 051 - 6781511
Fax +39 - 051 - 846349
rav@ravaglioli.com
www.ravaglioli.com

RAV France
4, Rue Longue Raie
ZAC de la Tremblaie
91220 Le Plessis Pâté
Tel. 01.60.86.88.16
Fax 01.60.86.82.04
rav@ravfrance.fr

Ravaglioli Deutschland
Kirchenpoint 22
85354 Freising
Tel. 08165-646956
Fax 08165-646958
info@ravaglioli.de

RAV Equipment UK LTD
Prince Albert House
20 King Street
Maidenhead, SL6 1DT
Tel. 020-76286832
Fax 020-76286833
ravuk@ravaglioli.com

RAV en Belgique
Nederlandstalig
Tel. 0498-162016
Fax 016-781025
Zone Francophone
Tel. 0498-163016
Fax 078 055030

RAV Equipos España
Avenida Europa 17
Pol. Ind. de Constanti
Tarragona 43120
Tel. 977 524525
Fax 977 524532
ravequipos@ravaglioli.e.telefonica.net

