



CAREL



CAREL

I/O Module





Introduction

The Carel I-OM is a new instrument from the following features:



compact (4 DIN modules)



versatile



simple to install



for panel mounting

What is the I/O module?

It's a product of the RETAIL Carel range.

Application: Monitoring-Retrofit

Why RETROFIT?

It can acquire informations in plants fitted with electromechanical control or non Carel electronics.

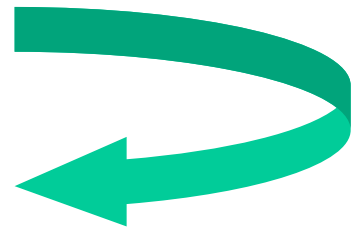

What can do the I/O module

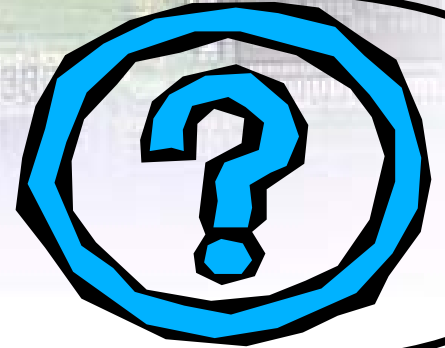

With Plant Visor it's a real complete Supervisory/Monitoring system.



WWW.

*will be monitored
by a simple PC
through supervisor system
(Plant Visor)*

*The informations
given by the I-OM*

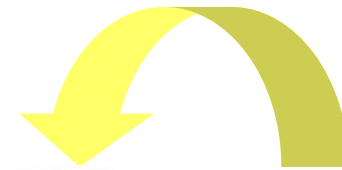
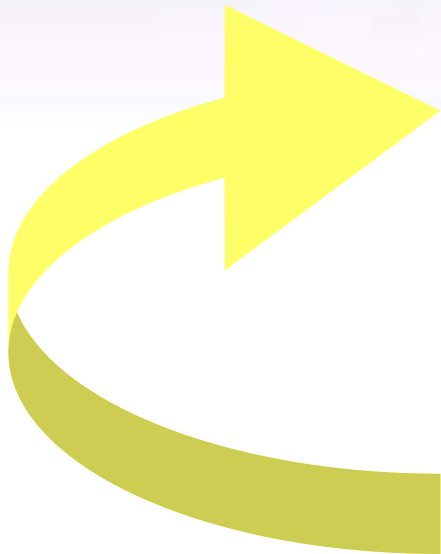

Connection

The I/O module can manage probes:

NTC



Standard Carel [-50÷+90°C]

4-20 mA



Temperature probes and pressure transducers

probes 5Vraz



VCC=5.02V

It can manage digital input:

Voltage opto-insolated
(n° 2 for instrument)

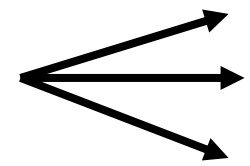

230Vac

115Vac

24Vac

Free contact
(n° 2 for instrument)



10mA

Electrical connections

Probe 5Vraz

Probe 4-20mA

Probe NTC

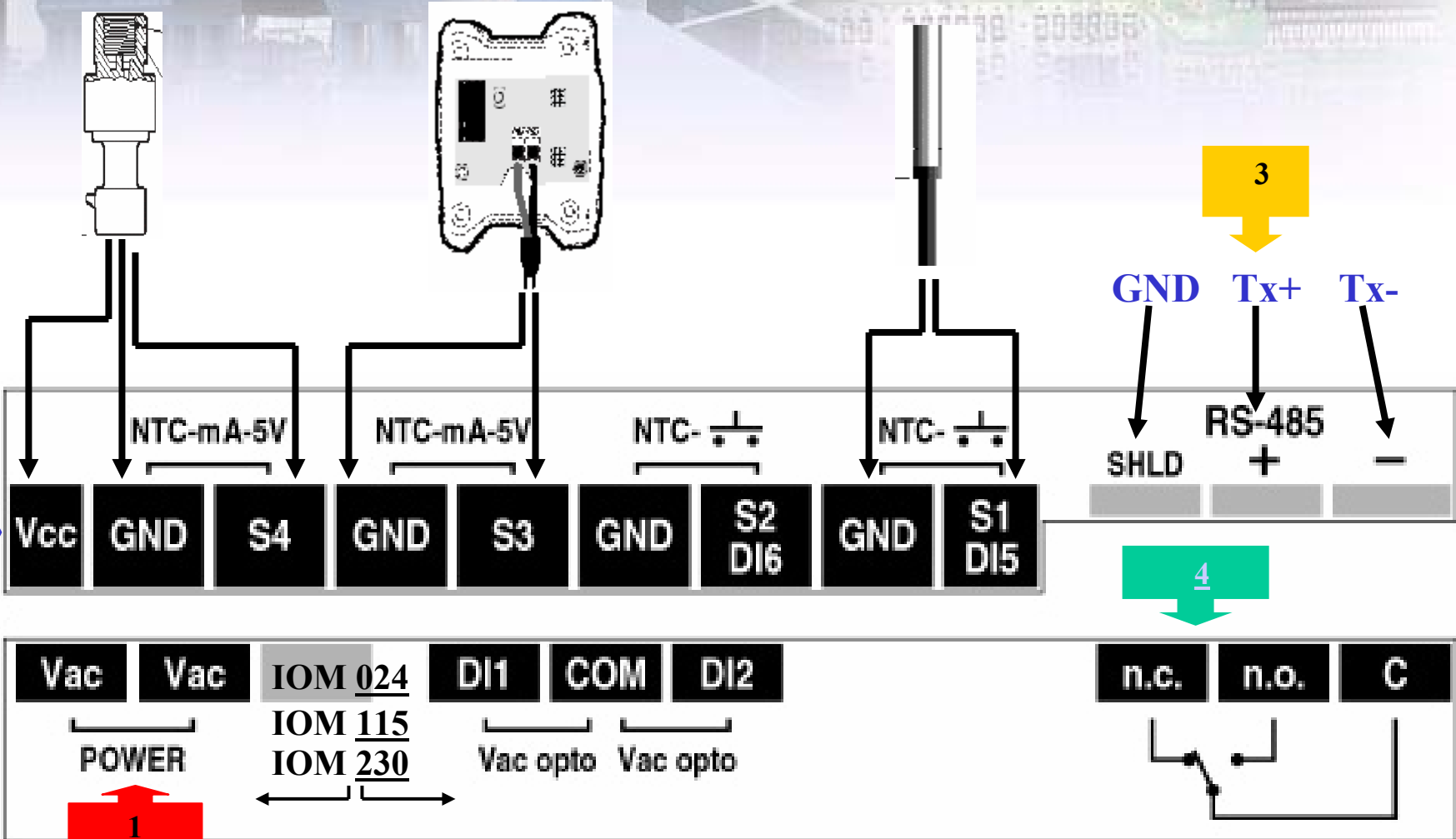

Alimentation

The power supply can be:

230 Vac



IOM0023000

115 Vac



IOM0011500

24 Vac



IOM0002400

Input combination

□ 4 NTC probes (in the analog inputs 1*,2*,3,4) +2 digit inputs D1,D2

*It is possible to configure them in digital input, respectively D5, D6 rather than in in analog input.

□ 2 digital inputs D5*,D6* +2 NTC probes in analog inputs 3,4 +2 digital inputs D1,D2

*If configured like that and not like analog.

□ The analog inputs 3,4 besides the NTC probes, can support voltages like 4-20mA or 5Vraz.



All in all

it is possible to configure:

□ 4 analog inputs

(of which only 3,4 can support NTC or 4-20mA or 5Vrat)

+

the two standard digital inputs D1,D2

....or

□ 4 digital and 2 analog inputs

(that support NTC, 4-20mA.5Vraz)



Serial output

The probe values and the operation parameters are available thanks to the serial output RS485 and to the supervisory system.

Supervision network

I/O module is scheduled to the RS485 serial communication with standard Carel protocol and speed.
Can be connected to the same 485 network until 100 I/O module.

Compatibility

Optimum application when used together with the PlantWatch and PlantVisor.

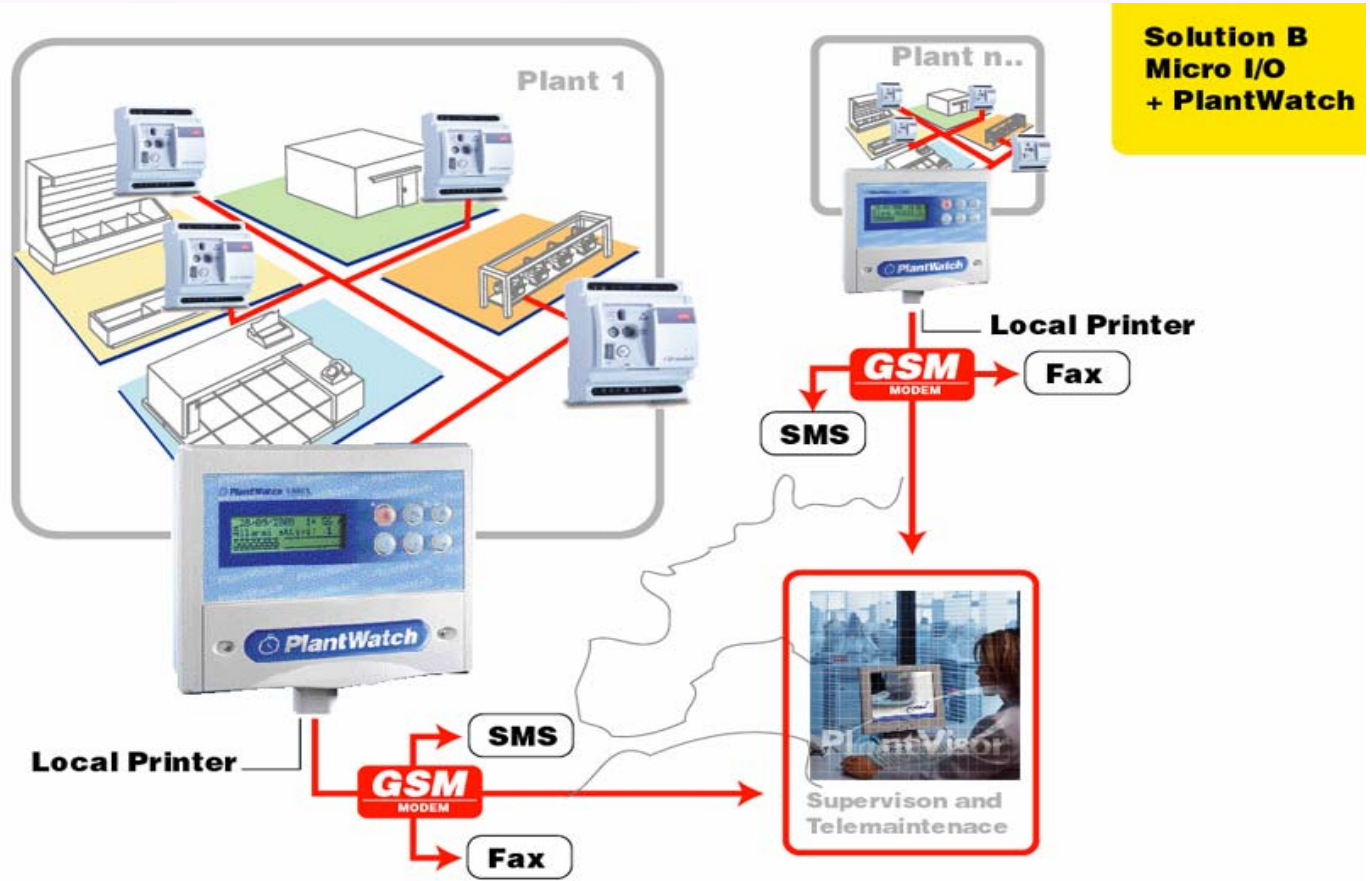

The modification of parameters and the I/O module supervision take place directly in the section provided of the Plant Visor.

Microsoft Internet Explorer

Visualizza Preferiti Strumenti ?

Termina Aggiorna Pagina iniziale Cerca Preferiti Cronologia Posta Stampa Modifica

.../First.htm

Vai Collegamenti

Services

Alarms/Events

Report

Service

Logout

Help

CAREL I/O module

25.4 °C	H1	High threshold of alarm for the probe 1 (FS disabled alarm)
25.4 °C	L1	Low threshold of alarm for the probe 1 (FS disabled alarm)
30.0 °C	H2	High threshold of alarm for the probe 2 (FS disabled alarm)
30.0 °C	L2	Low threshold of alarm for the probe 2 (FS disabled alarm)
-25.0 °C	H3	High threshold of alarm for the probe 3 (FS disabled alarm)
-25.0 °C	L3	Low threshold of alarm for the probe 3 (FS disabled alarm)
*** °C	H4	High threshold of alarm for the probe 4 (FS disabled alarm)
*** °C	L4	Low threshold of alarm for the probe 4 (FS disabled alarm)

*** °C
Probe 1

ACTIVE ALARMS

29/11/02 12:12:18 =====Start=====

Operazione completata

Intranet locale

Relè output

Power: 8 A resistive

- ❑ The relay output is managed by the telemaintenance system, as auxiliary if (OUT=0).
- ❑ If the suitable parameter is configured (OUT=1), the relay turns on automatically when the analog-digital inputs of the machine enter in alarm conditions (high/low temperature, damaged probes, input anomalies, time out defrost...).



Configuration

The configuration of the inputs, the relè output and alarms operating are customized by the supervision system or by key with cod. **PSOPZKEY00**

(is necessary a specific Software supplied by Carel)

User interface





Led 1 (Green)

The Power Supply LED turns on when the I/O module is properly powered.



Led 2 (Yellow)

- If ON, it signals the correct serial communication between the I/O module and the supervision system.
- The reading of the surveyed data from the instrument is available to be monitored



Led 3 (Red)

- If OFF, the operation is normal.
- If ON but not flashing, it signals the allarms inhibition for the time
- If flashing, it signals an alarm.



2 Rotary switch (BCD 0-99)

They can be regulated from 0 to 99, and supply a reading code (**serial address**) to the remote control system.

When more than one I/O module are connected to the same monitoring system, they determine the reading order.



Key

Programming writing/reading key of the internal parameters can be modified from the serial system.

Tool of programming Key



The Key Kit (PSOPZPRG00) includes:

- *1 parallel port connection cable*
- *1 convertor for Key (PSOPZKEY00) connection*
- *1 CD Rom with specific software of programming Key*

Key Software

The Keys present on the sheet "Parameters" (on the high left) enable to obtain the followings functions:

LETT : It reads the parameters memorized on the Key; they are visualized on the blue column.

SCRI : It writes the parameters on the Key (values previously inserts on the yellow column n).

CONF : It creates file that permit the I/O module configuration throught the Dtest or Plant Visor.

DEFAULT : It upload the default values about parameters on the writing column.

	A	B	I	J	K	U
	Let. Scri. Conf	Descrizione	Valore lettura	Valore scrittura	Unità di misura	
1	D11					
2	Default					
3	INFORMAZ.					
4	DISPOSIT.					
5		Checksum dati E2P		----	----	
6		Tipo macchina		122	----	
7		Versione software		1	----	
8	INGR. DIG.					
9	A1	Tipologia ingr. Digitale 1		0	----	
10	D1	Secondi di ritardo (ingr. Dig. 1): allarme, time-out defrost, tempo inibizione allarmi o tempo massimo cleaning cycle		20	secondi	
11	DK1	Secondi di mantenimento allarme ingr digit 1		20	secondi	
12	MTD1	Segnalazione in caso di timeout defrost da ingr 1		0	----	



Functions:

The functions managed by the device are mainly 7 :

[Probes]

- 1) Reading of the values and alarms related to the set thresholds

[Digital input]

- 2) Only reading function
- 3) Open input alarm
- 4) Closed input alarm
- 5) Defrost status
- 6) General alarm inhibition
- 7) Cleaning cycle status



Probes monitor

The measurements read by the probes installed on I/O module are monitored (**every 5 min**) by the supervision system, to satisfy the **HACCP** rule.



Reading digital inputs

The open/closed status of the devices connected to the digital inputs (selected like “Only reading”) will be monitored to the supervisor system



Open input alarm switch

At the digital switch opening, after any possible delay time (D1/2/5/6), the I/O module go in alarm status that will be memorized on the historical alarms of the supervisor system.



Closed input alarm switch

In this case the alarm will be active when the switch is closed, respecting the delay time of the parameter

D1/2/5/6.



Defrost status

This function permits the inhibition of the high/low alarms on the probes that are associate to the input in question when the switch closed.

The defrost endurance is setting with the parameter
D1/2/5/6.



General alarm inhibition

- The digital input qualified to this function is able to inhibit all the alarms after the closing of the switch in question.
- The inhibition is maintained until all the time **D1/2/5/6**.

It could correspond to the OFF status of unit controlled.



Cleaning cycle

This is a function that permits to inhibit the alarms and to signals the end of the cleaning cycle during all the time **D1/2/5/6 spent for the cleaning or the maintenance of the system until a new rehabilitation of the contact.**

COLD ROOM

I O M

Input-Output Modules

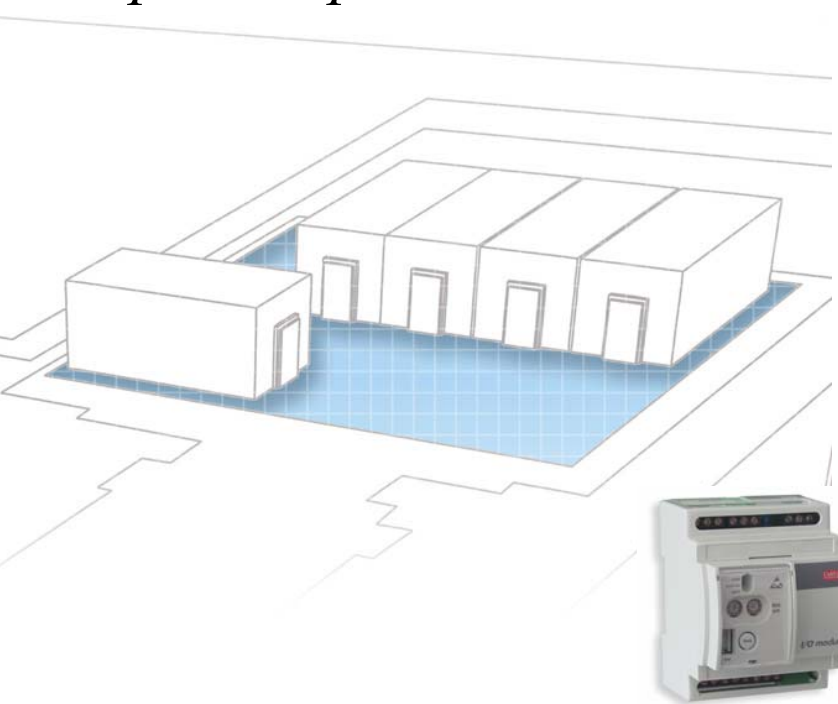

- Regulation (food)
Temperature → **NTC 1**
- Defrost
Temperature → **NTC 2**
- Defrosting → **DI defrost**
- Refrigerating → **DI ®**
- Fans running → **DI ®**
- Auxiliary / door
switch → **DI alarm n.o/n.c**
- remote Alarm /
Auxiliary output → **RELE'**

COMPRESSION UNIT

I O M

Input-Output Modules

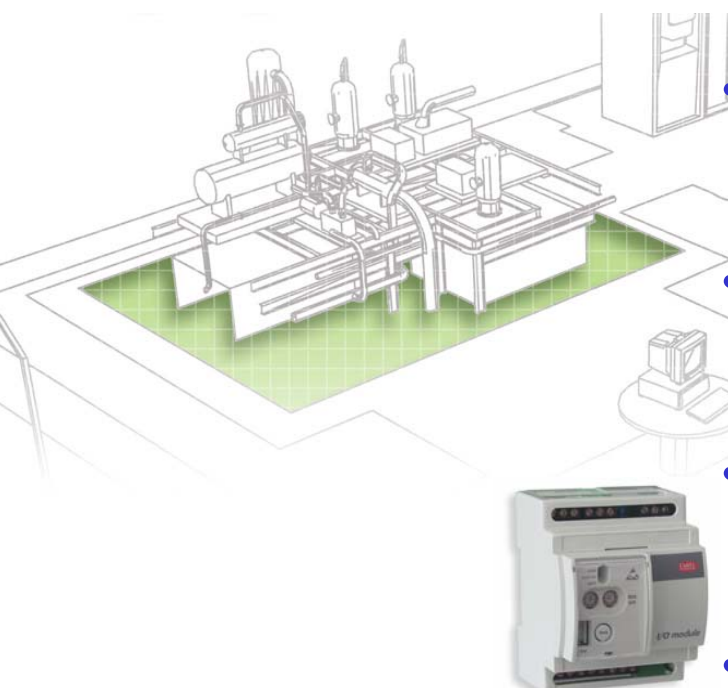

• Suction Pressure → Probe 4-20mA

• Discharge Pressure → Probe 4-20mA

• Compressor status (up to 3)
→ DI ®
→ DI ®
→ DI ®

• General failure → DI alarm n.o/n.c

• remote Alarm / Auxiliary output → RELE'

SINGLE LINE SHOWCASE

I O M

Input-Output Modules

- Regulation (food) Temperature for EACH unit

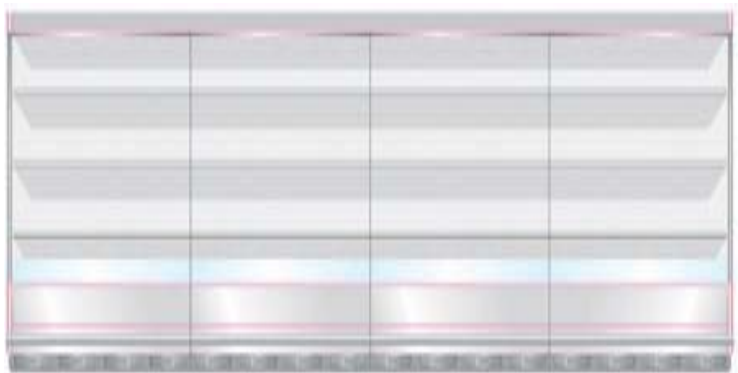
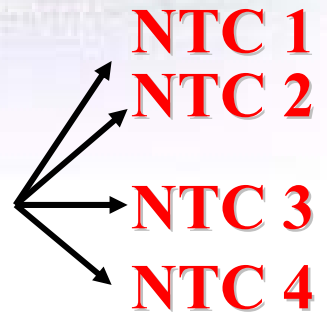

- Defrosting (group) → DI defrost
- Refrigerating (group) → DI ®



- Light on/off from remote System → RELE'

Prezzi:

<i>Code</i>	<i>Description</i>	<i>Price list</i>
IOM0002400	<i>Modulo 24 Vac</i>	<i>Euro 102.00</i>
IOM0011500	<i>Modulo 115 Vac</i>	<i>Euro 107.00</i>
IOM0023000	<i>Modulo 230 Vac</i>	<i>Euro 105.00</i>
PSOPZKEY00	<i>Programming Key</i>	<i>Euro 56.80</i>
PSOPZPRG00	<i>Tool of programming Key</i>	<i>Euro 80.00</i>



www.carel.com