

humiFog direct

CAREL



ENG User manual

**LEGGI E CONSERVA
QUESTE ISTRUZIONI**
→ **READ AND SAVE
THESE INSTRUCTIONS** ←

  **NO POWER
& SIGNAL
CABLES
TOGETHER**
READ CAREFULLY IN THE TEXT!

Integrated Control Solutions & Energy Savings



IMPORTANT WARNINGS:

The humidifiers manufactured by CAREL are advanced products, whose operation is specified in the technical documentation supplied with the product that can be downloaded, even prior to purchase, from the website www.carel.com. Every product made by CAREL Industries, in relation to its advanced level of technology, requires a qualification / configuration / setup phase in order to best fulfil your specific application. The lack of such phase of study, as indicated in the manual, can cause the final product to malfunction, of which CAREL cannot be held responsible. The client (builder, developer or installer of the final equipment) assumes all responsibility and risk relating to the configuration of the product in order to achieve the expected results in relation to the specific final installation and/or equipping. In this case, subject to specific agreements, CAREL acts as a consultant for the success of the installation / start-up / use of the machine, but in no case does it accept liability for proper operation of the humidifier and of the final plant, should the warnings and recommendations in this manual or in any other technical documentation of the product not be followed. In particular, in addition to the obligation to observe the above mentioned warnings and recommendations for proper use of the product, we recommend paying attention to the following warnings:

- **DANGER ELECTRIC SHOCK:** The humidifier includes live electrical parts. Disconnect the power supply before accessing internal parts, in case of maintenance and during installation.
- **DANGER WATER LEAKS:** The humidifier automatically and constantly sucks in/drains quantities of water. Malfunctions in the connections or humidifier may cause leaks.



WARNING:

- Environmental and power supply conditions must conform to the values specified on the product rating labels.
- Only qualified personnel who are aware of the necessary precautions and able to perform the required operations correctly may install, operate or carry out technical service on the product.
- Only water with the characteristics indicated in this manual must be used.
- All operations on the product must be carried out according to the instructions provided in this manual. Any uses or modifications that are not authorised by the manufacturer are considered improper. CAREL Industries declines all liability for any such unauthorised use.
- Do not attempt to open the system in ways other than those described in this manual.
- Observe the standards in force in the place where the humidifier is installed.
- Keep the humidifier out of the reach of children and animals.
- Do not install and use the product near objects that may be damaged when in contact with water (or condensate). CAREL Industries declines all liability for direct or indirect damage following water leaks from the humidifier.
- Do not use corrosive chemicals, solvents or aggressive detergents to clean the inside and outside parts of the humidifier, unless specifically indicated in the user manual.
- Do not drop, hit or shake the humidifier, as the inside parts and the linings may be irreparably damaged.

CAREL adopts a continuous development policy. Therefore, CAREL reserves the right to carry out modifications and improvements to any product described in this document without prior notice. The technical data in the manual can undergo modifications without forewarning. The liability of CAREL in relation to its own product is governed by CAREL general contract conditions published on the website www.carel.com and/or by specific agreements with clients; in particular, within the limits set by the applicable law, in no way will CAREL, its employees or its branch offices/affiliates be responsible for any lack of earnings or sales, loss of data and information, cost of replacement goods or services, damage to objects or persons, work interruptions, or any direct, indirect, accidental, patrimonial, coverage, punitive, special or consequential damage in any way caused, be they contractual, out-of-contract, or due to negligence or other responsibility originating from the installation, use or inability of use of the product, even if CAREL or its branch offices/affiliates have been warned of the possible damage.



DISPOSAL:

The humidifier consists of metal parts and plastic parts. With reference to the European Parliament and Council Directive 2002/96/EC issued on 27 January 2003 and the related national implementation legislation, please note that:

1. WEEE cannot be disposed of as municipal waste, said waste must be collected separately;
2. the public or private waste collection systems defined by local legislation must be used. Moreover, the equipment can be returned to the distributor at the end of its working life when buying new equipment;
3. the equipment may contain hazardous substances: the improper use or incorrect disposal of such may have negative effects on human health and on the environment;
4. the symbol (crossed-out wheeled bin) shown on the product or on the packaging and on the instruction sheet indicates that the equipment has been introduced onto the market after 13 August 2005 and that it must be disposed of separately;
5. in the event of illegal disposal of electrical and electronic waste, the penalties are specified by local waste disposal legislation.

Warranty for materials: 2 years (from the manufacture date, excluding consumables).

Certification: the quality and safety of CAREL products are guaranteed by CAREL's ISO 9001 certified design.

Contents

1. CARATTERISTICHE GENERALI E MODELLI	7	7. MASTER/SLAVE NETWORK OF HUMIDIFIERS	25
1.1 General description	7	7.1 Description of the Master/Slave system	25
1.2 Operating principle	7	7.2 Network switch for Master/Slave connection	25
1.3 Cabinet part numbers	8	7.3 Type of Master/Slave system installation	25
1.4 Hose part numbers	8	7.4 Master/Slave system configuration	26
1.5 Blower unit part numbers	8	8. CONNECTIVITY	28
1.6 Main components	9	8.1 Webservice	28
1.7 Dimensions and weights	10	8.2 Supervisor connection	29
1.8 Packaging and shipment	10	8.3 List of Modbus parameters	29
1.9 IP rating and standards	10	8.4 List of BACnet parameters	30
2. CABINET INSTALLATION	11	9. WIRELESS PROBES, INSTALLATION AND CONFIGURATION	31
2.1 Positioning	11	9.1 Type of installation and wireless probe electrical connections	31
2.2 Cabinet water connections	11	9.2 Wireless probe installation	31
2.3 Cabinet electrical installation	12	10. ALARM TABLE	32
2.4 Changing the oil cap	13	11. MAINTENANCE	35
3. DISTRIBUTION SYSTEM INSTALLATION	13	10.1 Routine maintenance	35
3.1 Blower unit installation	13	10.2 Special maintenance	35
3.2 Mounting single blower units on the wall / ceiling	14	10.3 Pump maintenance	35
3.3 Mounting double blower units on the ceiling	14	10.4 50 hour oil change warning	36
3.4 Blower unit electrical connection	15	10.5 Maintenance warning and alarm, reset hour counter	36
4. ELECTRONIC CONTROLLER SET UP AND CONNECTIONS	16	10.6 Blower spare parts	36
4.1 Remote ON/OFF signal connection	16	10.7 Cabinet spare parts	37
4.2 Analogue signal from the main probe and limit probe in the first zone	16	12. APPENDIX	38
4.3 Analogue signal from the main probe and limit probe in the second zone	16	12.1 Single-zone cabinet wiring diagram	38
4.4 Analogue signal from an external controller	17	12.2 Two-zone cabinet wiring diagram	39
4.5 Digital signal from humidistat or external controller	17	12.3 Datasheets	40
4.6 Serial or Ethernet communication	17		
4.7 Alarm relay output	17		
4.8 Unit status digital output	17		
4.9 Production percentage analogue outputs	18		
5. START-UP AND USER INTERFACE	19		
5.1 Start-up	19		
5.2 Keypad	19		
5.3 Configuration wizard	19		
5.4 Main screen	19		
5.5 Graphic area 2 – Request / Probe reading	20		
5.6 Graphic area 3 – Notification centre	20		
5.7 Graphic area 4 – Unit status	20		
5.8 Graphic area 5 – Quick access menu	20		
5.9 Graphic area 6 – Zone status icon	21		
5.10 Alarms	21		
6. OPERATION OPTIONS	22		
6.1 Main menu and overview of functions	22		
6.2 Scheduler	23		
6.3 Proportional control to an external signal (modulating operation)	23		
6.4 Autonomous control with humidity probes	23		
6.5 Modulation of production	24		

1. CARATTERISTICHE GENERALI E MODELLI

1.1 General description

humiFog Direct is a direct humidifier for room installation. It consists of a pumping unit (also called the cabinet) and a distribution system (comprising blower units) to be installed directly in the room to be humidified and cooled. The pumping unit is connected to the blower units by high pressure hoses.

The cabinet is fitted with a pump that delivers water at high pressure (70 bars) to the nozzles on the blower units, where it is atomised into very fine droplets that evaporate spontaneously.

The cabinets are available in the single zone and two-zone version. The latter can manage two independent zones, reading two separate signals (from a probe or external controller).

For all models, the minimum flow-rate delivered by the pump is 8 l/h. For this reason, it is recommended to couple a distribution line that can atomise a flow-rate of water equal at least to the minimum flow-rate delivered by the pump.

It is important to install the distribution system in a suitable environment (in terms of volume, air change and operating temperature) so as to ensure absorption of the atomised water. Carel can provide support for calculating the required humidification load.

1.2 Operating principle

System operation is based on a request signal from a probe (temperature or humidity) or external controller. When operation is enabled (remote on/off) and at the same time there is a humidification or cooling request signal, the system opens the fill solenoid valve and activates the pump, which pumps the water at high pressure (70 bars). After having also opened the outlet solenoid valve, the initial stage of operation begins, involving washing and filling the line, after which, when the line is filled and pressurised, the nozzles will start spraying water.

Modulation is available in PWM mode (pulse width modulation): the controller alternates a period (set on the display) in which the outlet solenoid valves are operation, thus atomising the water, with period in which the outlet valves are closed and the bypass valve is open, thus interrupting atomisation into the room.

The set point is managed directly by the electronic controller using a proportional band (P+) or an offset when reaching the set point.

On reaching the set point, the system stops and enters standby mode, restarting when there is a new request. For this reason, the system should be powered on at all times.

1.2.1 Functional diagram

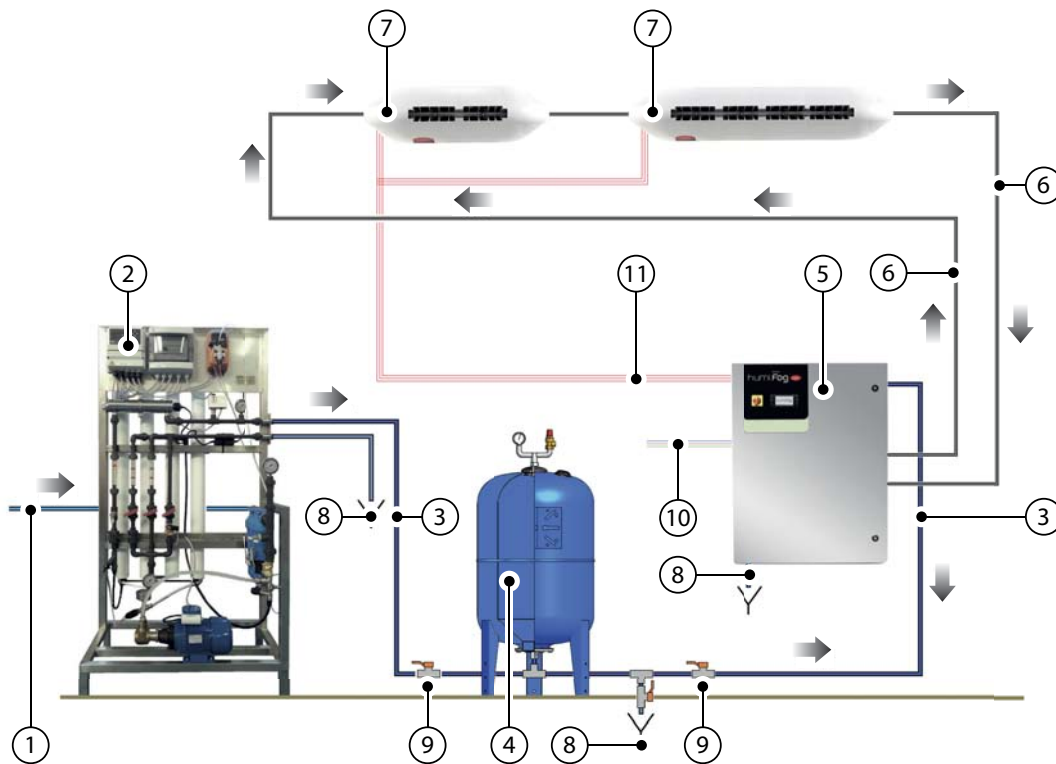

Fig. 1.a

Key

1	Mains water line
2	Reverse osmosis system
3	Demineralised water line
4	Expansion vessel
5	humiFog Direct cabinet
6	High pressure water hoses (70 bars)

7	humiFog Direct blower units
8	Water drain point
9	On-off ball valve
10	Power supply (230V 50 Hz or 120V 60 Hz)
11	Electrical connection from cabinet to the blowers

1.3 Cabinet part numbers



Fig. 1.b

The cabinets differ in terms of flow-rate delivered by the pump, power supply voltage/frequency, and the capacity to control one or two atomisation racks, managed independently from each other.

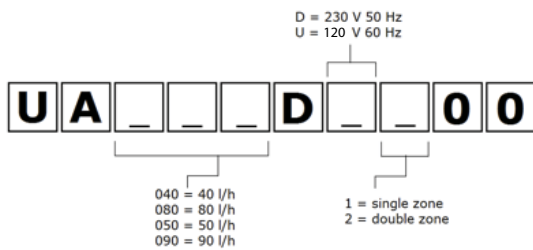

Part numbers available:

UA040DD100	40 l/h, 230V 50Hz, single zone
UA040DD200	40 l/h, 230V 50Hz, two zones
UA080DD100	80 l/h, 230V 50Hz, single zone
UA080DD200	80 l/h, 230V 50Hz, two zones
UA050DU100	50 l/h, 120V 60Hz, single zone
UA050DU200	50 l/h, 120V 60Hz, two zones
UA090DU100	90 l/h, 120V 60Hz, single zone
UA090DU200	90 l/h, 120V 60Hz, two zones

Tab. 1.a

N.B. to manage the 230V - 60 Hz power supply a 230V-120V transformer can be installed upstream and connected to the cabinet. The transformer must be installed according to safety standards in force.

1.4 Hose part numbers

The high pressure hoses (OD = 10 mm, ID = 6.4 mm) are supplied by Carel in different lengths. The part numbers available are listed below. All the hoses have with M16x1.5 female couplings with O-rings, ideal for direct connection to the cabinet and the blower units without needing to use sealants. Each hose kit includes an M16x1.5 nipple to be used for coupling different hoses together.

Stainless steel pipes can also be used to connect the blowers to the cabinet. The recommended outside diameter is 10 mm. This solution is the installer's responsibility.

Carel recommends using hoses rather than pipes.

UAKT005014	High pressure hose, L = 0.5 m
UAKT010014	High pressure hose, L = 1.0 m
UAKT020014	High pressure hose, L = 2.0 m
UAKT050014	High pressure hose, L = 5.0 m
UAKT100014	High pressure hose, L = 10 m
UAKT200014	High pressure hose, L = 20 m

Tab. 1.b

1.5 Blower unit part numbers



Fig. 1.c

The blower units differ based on the number of nozzles, the type of nozzles (the nozzles are already pre-assembled in the factory), power supply voltage/frequency and the direction of spray (front or two directions).

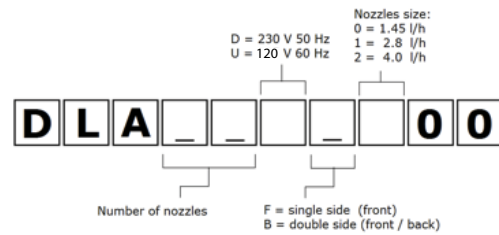

Part numbers available:

P/N	230 V 50 Hz BLOWERS (CE)
DLA02DF000	Front blower 3.0 l/h (2 x 1.45 l/h nozzles) 230 V 50 Hz
DLA02DF100	Front blower 5.0 l/h (2 x 2.8 l/h nozzles) 230 V 50 Hz
DLA02DF200	Front blower 8.0 l/h (2 x 4.0 l/h nozzles) 230 V 50 Hz
DLA04DF000	Front blower 6.0 l/h (4 x 1.45 l/h nozzles) 230 V 50 Hz
DLA04DF100	Front blower 11.0 l/h (4 x 2.8 l/h nozzles) 230 V 50 Hz
DLA04DF200	Front blower 16.0 l/h (4 x 4.0 l/h nozzles) 230 V 50 Hz
DLA04DB000	Double blower 6.0 l/h (4 x 1.45 l/h nozzles) 230 V 50 Hz
DLA04DB100	Double blower 11.0 l/h (4 x 2.8 l/h nozzles) 230 V 50 Hz
DLA04DB200	Double blower 16.0 l/h (4 x 4.0 l/h nozzles) 230 V 50 Hz
DLA08DB000	Double blower 12.0 l/h (8 x 1.45 l/h nozzles) 230 V 50 Hz
DLA08DB100	Double blower 22.0 l/h (8 x 2.8 l/h nozzles) 230 V 50 Hz
DLA08DB200	Double blower 32.0 l/h (8 x 4.0 l/h nozzles) 230 V 50 Hz

Tab. 1.c

P/N	120 V 60 Hz BLOWERS
DLA02UF000	Front blower 3.0 l/h (2 x 1.45 l/h nozzles) 120 V 60 Hz
DLA02UF100	Front blower 5.0 l/h (2 x 2.8 l/h nozzles) 120 V 60 Hz
DLA02UF200	Front blower 8.0 l/h (2 x 4.0 l/h nozzles) 120 V 60 Hz
DLA04UF000	Front blower 6.0 l/h (4 x 1.45 l/h nozzles) 120 V 60 Hz
DLA04UF100	Front blower 11.0 l/h (4 x 2.8 l/h nozzles) 120 V 60 Hz
DLA04UF200	Front blower 16.0 l/h (4 x nozzles from 4.0 l/h) 120 V 60 Hz
DLA04UB000	Double blower 6.0 l/h (4 x 1.45 l/h nozzles) 120 V 60 Hz
DLA04UB100	Double blower 11.0 l/h (4 x 2.8 l/h nozzles) 120 V 60 Hz
DLA04UB200	Double blower 16.0 l/h (4 x 4.0 l/h nozzles) 120 V 60 Hz
DLA08UB000	Double blower 12.0 l/h (8 x 1.45 l/h nozzles) 120 V 60 Hz
DLA08UB100	Double blower 22.0 l/h (8 x 2.8 l/h nozzles) 120 V 60 Hz
DLA08UB200	Double blower 32.0 l/h (8 x 4.0 l/h nozzles) 120 V 60 Hz

Tab. 1.d

1.6 Main components

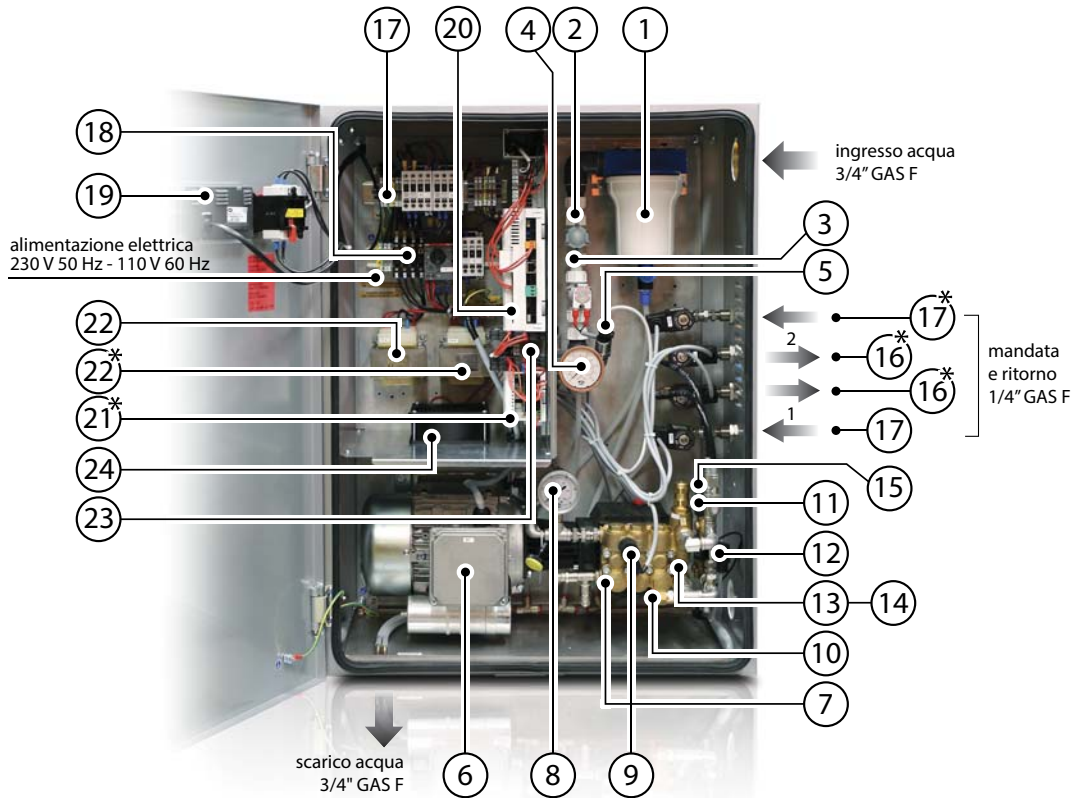

Fig. 1.d

Cabinet water circuit

Ref.	Description
1	Water inlet filter
2	Pressure reducer
3	NC fill solenoid valve
4	Low pressure gauge
5	Low pressure gauge
6	Motor
7	Pump
8	High pressure gauge
9	High pressure sensor
10	Temperature-controlled safety valve
11	High pressure sensor
12	Temperature sensor
13	Overflow valve
14	Drain solenoid valve
15	Bypass solenoid valve
16	NC fill solenoid valve
17	NO return solenoid valve
18	Fuse kit
19	pGD display
20	Controller
21	Expansion card
22	Transformer
23	SSR
24	Cooling fan

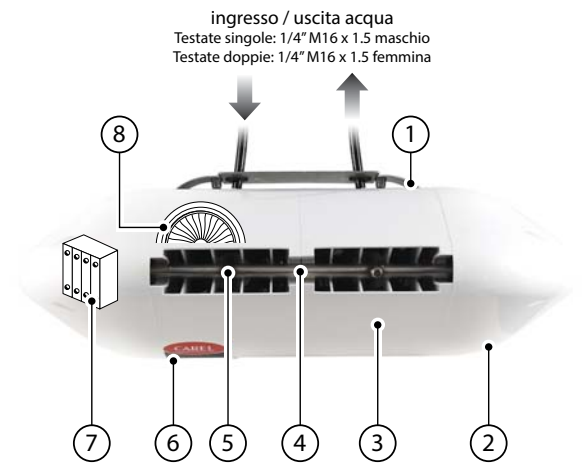

Fig. 1.e

Ref.	Description
1	metal support / wall bracket
2	side plastic cover
3	centre plastic cover
4	pressurised water manifold
5	nozzle
6	power LED
7	terminal block for blower power supply
8	fan

1.7 Dimensions and weights

1.7.1 Dimensions and weights of the cabinet

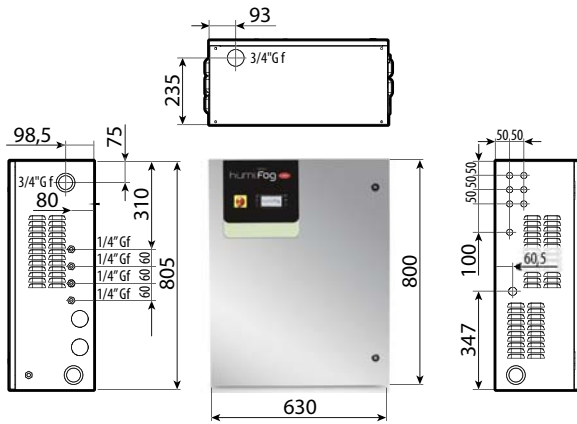

Fig. 1.f

Dimensions 630x300x800 mm (24.8"x11.8"x31.5")	Weight			
	UA040-UA050		UA080-UA090	
	single zone	two zones	single zone	two zones
	60 kg (132 lb)	64 kg (141 lb)	64 kg (141 lb)	68 kg (149 lb)

Tab. 1.e

1.7.2 Dimensions and weights of the single blowers

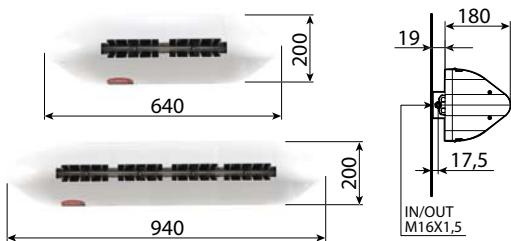

Fig. 1.g

P/N	Dimensions [a x b x c]	Weight
DLA02xFx00	640 x 200 x 180 mm (25 x 8 x 7 inches)	4.5 kg (9 lb)
DLA04xFx00	940 x 200 x 180 mm (37 x 8 x 7 inches)	5.6 kg (12 lb)

Tab. 1.f

1.7.3 Dimensions and weights of the double blowers

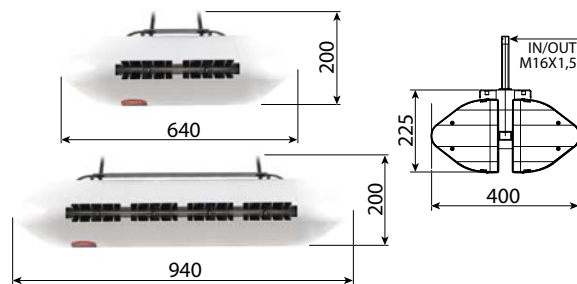

Fig. 1.h

P/N	Dimensions [a x b x c]	Weight
DLA04xBx00	640 x 200 x 400 mm (25 x 8 x 16 inches)	9.2 kg (20 lb)
DLA08xBx00	940 x 200 x 400 mm (37 x 8 x 16 inches)	15.5 kg (34 lb)

Tab. 1.g

1.8 Packaging and shipment

The cabinet is packaged and delivered on a wooden pallet with a cardboard cover. The user is responsible for moving the cabinet near the point of operation, removing the packaging and placing it in a position ready for the water and electrical connections.

The blowers are delivered already assembled in cardboard boxes. The user is responsible for removing the blower from the packaging, removing the side plastic covers so as to make the water and electrical connections, and then replacing the plastic covers before starting the system.

1.8.1 Dimensions and weights of the packages

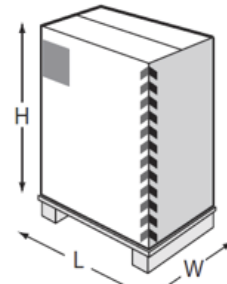

Fig. 1.i

Dimensions 720x460x1020 mm (28.5"x18"x40")	Weight			
	UA040-UA050		UA080-UA090	
	single zone	two zones	single zone	two zones
	64 kg (141 lb)	68 kg (149 lb)	68 kg (149 lb)	72 kg (158 lb)

Tab. 1.h



Fig. 1.j

P/N	Dimensions [L x W x H]	Weight
DLA02xFx00	755 x 235 x 295 mm (30 x 9 x 12 inches)	5.7 kg (12 lb)
DLA04xFx00	1050 x 235 x 295 mm (41 x 9 x 12 inches)	7.4 kg (16 lb)
DLA04xBx00	755 x 470 x 295 mm (30 x 18 x 12 inches)	11.4 kg (25 lb)
DLA08xBx00	1050 x 470 x 295 mm (41 x 18 x 12 inches)	18 kg (39 lb)

Delivery and storage temperature must be between -10°C - 50°C and humidity between 0% - 90% non-condensing.

1.9 IP rating and standards

The IP rating of the cabinet is IP20.

The IP rating of the blowers is IP20.

The IP rating of the blowers is not a problem for installation, as all the components inside have a higher IP rating.

The blowers can in fact be installed in rooms with very high humidity (up to 95% non-condensing).

The unit is compliant with the Machinery Directive.

The unit is CE marked in the 230 Vac 50 Hz version in accordance with IEC 60335-1, IEC 60335-2, EN 60335, EN 61000-6-2 (2006) and EN 61000-6-4 (2007).

The unit is UL marked in the 120 Vac 60 Hz version in accordance with directive UL998.

2. CABINET INSTALLATION

2.1 Positioning

The cabinet, being IP20, must be installed in a closed compartment, sheltered from the rain, water spray and direct sunlight.

The cabinet must be installed in an environment with a temperature between 5 and 40°C.

Around 1 m clearance must be left in front of the cabinet to allow the door to be opened and maintenance to be performed. Around 0.5 m clearance needs to be left on both sides of the cabinet to allow space for the water connections on the right and electrical connections on the left.

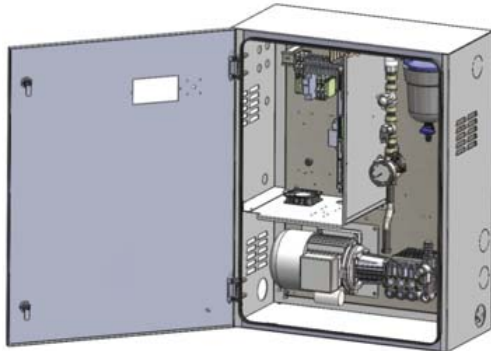

Fig. 2.a

2.1.1 Wall mounting

The cabinets can be wall-mounted or floor-standing.

In the event of wall mounting, it is recommended to use the metal frames and screws supplied. See the distances shown in the following image for drilling the holes and fastening the brackets.

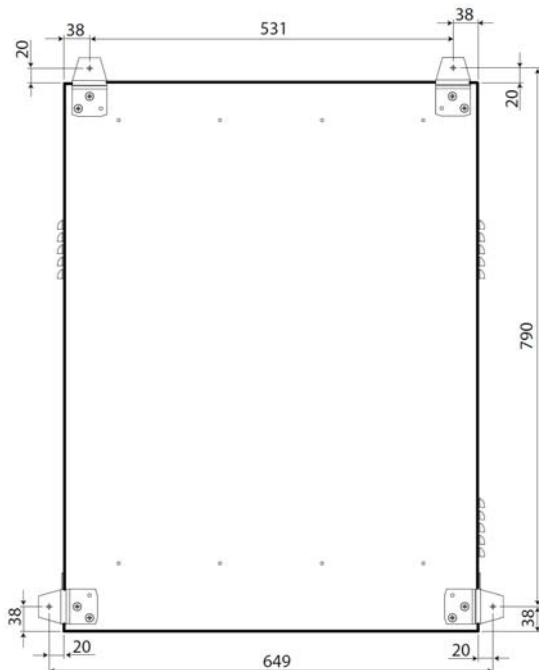

Fig. 2.b

2.1.2 Floor-standing installation

For floor-standing installation, the unit needs to rest on a raised platform so as to allow connection of the drain hose, located on the bottom of the cabinet (see chapter 2.2.3).

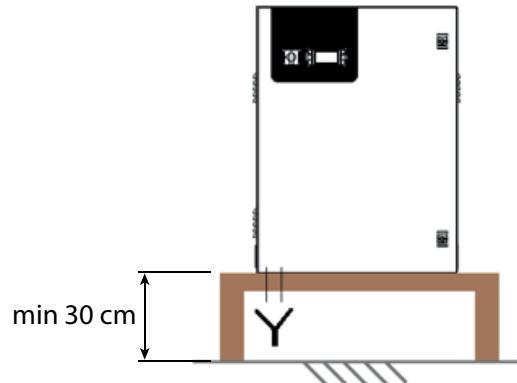

Fig. 2.c

2.2 Cabinet water connections

2.2.1 Feedwater line

An expansion vessel should always be installed upstream of the cabinet, so as to attenuate variations in pressure in the feedwater line. A 10 µm mesh filter should also be installed, in addition to the filter already supplied inside the cabinet. Finally, an on-off ball valve should be installed on the line upstream of the cabinet, so as to allow for any maintenance operations on the water circuit downstream.

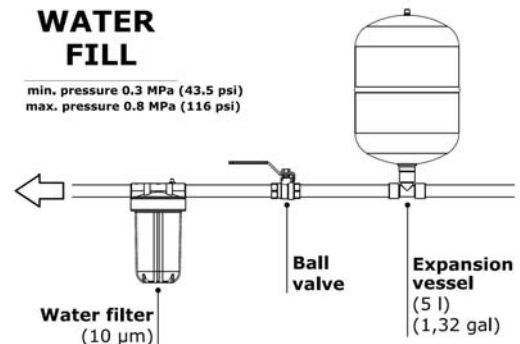

Fig. 2.d

A hose with a minimum diameter $\varnothing=1/2"$ should be connected upstream of the cabinet so as to ensure the right flow-rate and pressure to the humidifier. The humidifier inlet connection is 3/4" GAS F. The required humidifier inlet pressure is at least 3 bars.

2.2.2 Feedwater characteristics

- humifog Direct requires demineralised water, so as to ensure:
- minimum maintenance;
 - no blockages of the nozzles;
 - no dust (the droplets that evaporate will not leave mineral salts in the environment);
 - improved hygiene.

The use of demineralised water is also required to comply with standards UNI8883, VDI6022 and VDI3803.

humifog Direct must only operate on demineralised water that falls within the limits listed in the following table. Normally, these values can be obtained by reverse osmosis or nanofiltration of the feedwater.

Specific conductivity	25 - 80 µS/cm
pH	5.5 - 8.5
Total hardness (TH)	0 - 25 mg/l CaCO ₃
Temporary hardness	0 - 15 mg/l CaCO ₃
Chlorides (Cl)	0 - 10 ppm Cl
Iron + manganese (Fe + Mn)	0 mg/l
Silicon dioxide (SiO ₂)	0 - 1 mg/l
Chlorine ions (Cl ⁻)	0 mg/l
Calcium sulphate (CaSO ₄)	0 - 5 mg/l

2.2.3 Cabinet drain connection

The drain point located at the bottom of the cabinet must be connected externally (3/4" GAS F fitting) to an open discharge with drain trap.

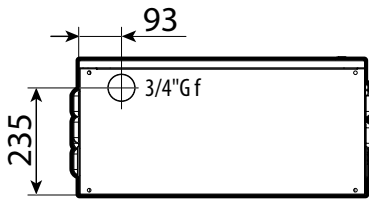

Fig. 2.e

Also remember that the cabinet cannot be installed on the floor without a support that keeps the cabinet raised by at least 20-30 cm.

2.2.4 Blower water supply line

With reference to the high-pressure hoses provided by CAREL (inside diameter Ø = 6.3 mm), in order to ensure correct operation of the atomisation system, the water supply line to the blowers in a single zone must respect the following maximum lengths:

Model	Rated pump capacity [L/h]	Maximum hose length supplying the blowers* [m]
UA040DD**/ UA050DU**	40/50	50
UA080DD**/ UA090DU**	80/90	100

Tab. 2.i

* The values shown refer to the water circuit in a single zone.

These lengths refer to linear metres of the hoses making up the water circuit, from the fill valve to the drain valve in the single zone, as shown in Fig. 1.a (part no. 6). Contact CAREL for longer circuit lengths.

2.3 Cabinet electrical installation

The cabinet must be connected to the mains by the user.
230 V 50 Hz for cabinet CE version UA***DD*00
120 V 60 Hz for cabinet UL version UA***DU*00

The connection must be compliant with local standards, using a suitably-sized cable.

A three-wire cable (line + neutral + earth/ground) must be connected to the three terminals (L + N + GR).

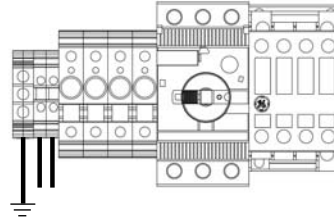

Fig. 2.f

Cabinet terminal	Power cable
L	L / F (line)
N	N / W (neutral)
GR	GR / PE (earth)

Important: fit an external power switch on the humidifier power supply line to isolate the power supply, and a TT earthing system with earth fault current of 30 mA.

No additional wiring is required to the cabinet terminal block, except for the power supply to the blower fans, using the terminals. For the electrical connections from the cabinet to the blowers, see chapter 3.4.

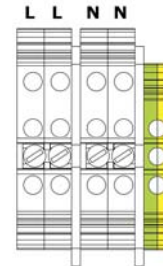

Fig. 2.g

2.3.1 Fuses

The following table lists the technical specifications of the fuses supplied for the different cabinets:

UA040DD100	UA080DD100	F1: 2.5 A (upstream of the transformer)
UA050DU100	UA090DU100	F2: 2.5 A (upstream of the transformer)
single zone		F3: 4.0 A (downstream of the transformer)
UA040DD200	UA080DD200	F1: 2.5 A (upstream of the transformer)
UA050DU200	UA090DU200	F2: 2.5 A (upstream of the transformer)
two zones		F3: 2.5 A (upstream of the transformer)
		F4: 2.5 A (upstream of the transformer)
		F5: 4.0 A (downstream of the transformer)
		F6: 4.0 A (downstream of the transformer)

Tab. 2.j

Fuses F1, F2, F3, F4 are placed in fuse carriers (Fig. 2.h).

Fuses F5, F6 are placed on the top of the respective transformers (components no. 21 and 22 in Fig. 1.d).

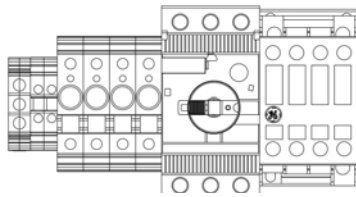

Fig. 2.h

2.4 Changing the oil cap

During installation, before starting the unit, remember to replace the red oil cap (A) on the pump with the yellow one (B) supplied. The red cap is closed and is only used for transport. The yellow cap has a vent opening and is used for normal operation of the system. The yellow cap is supplied inside the cabinet, tied to the high pressure gauge (see the image below).

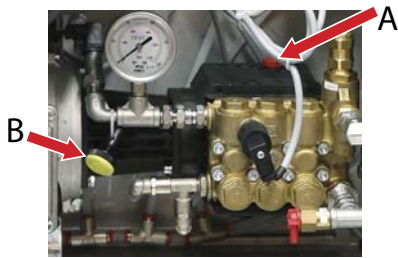

Fig. 2.i

3. DISTRIBUTION SYSTEM INSTALLATION

3.1 Blower unit installation

The humiFog Direct system works by connecting the cabinet to a number of blower units installed directly in the room to be humidified and/or cooled.

The following simple rules must be kept in mind when installing the blower units:

- the minimum flow-rate that can be atomised in the room is 8 l/h (irrespective of the size of the pump). The minimum number of blower units must therefore be defined based on the number and size of the chosen nozzles.

The maximum numbers of blower units that can be connected to a cabinet are:

- 12 blower units with 2 nozzles
- 6 blower units with 4 nozzles
- 3 blower units with 8 nozzles

The blower units must be suitably positioned so as to allow complete absorption of the sprayed water. Consequently it is recommended to install the blowers a due distance apart, at a sufficient height from the floor and with free space at the front without obstacles.

The blower units can be mounted either on the wall or on the ceiling.

For a correct installation, it is advisable to observe the distances and adjustments shown in Fig. 3.a.

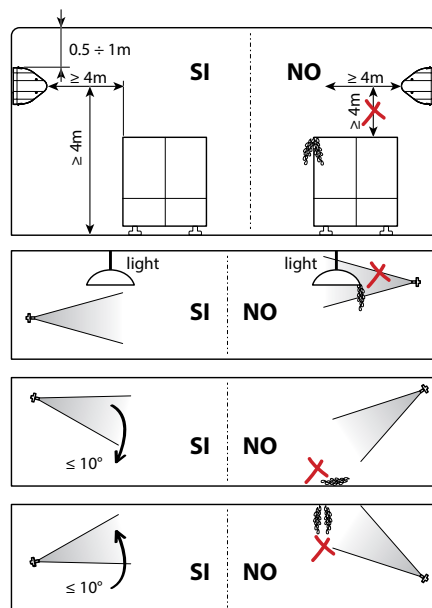

Fig. 3.a

The blower unit installation procedure is as follows:

1. Unpack the blower unit from the box it was delivered in. The blower units are delivered fully assembled.
2. Remove the side plastic covers cover from the blower. Unscrew the long screws on the side using a screwdriver. Make sure to keep the screws, as they will be needed again for assembly at the end.
3. Mount the blower unit on the metal support. See paragraph 3.2 for details.
4. Connect the water line to the inlet on the blower units (M16x1.5). See paragraph 3.3 for details.
5. Electrically connect the blower units to the cabinet, which supplies power and controls operation of the fans. See paragraph 3.4 for details.
6. Complete blower assembly by repositioning the side plastic covers removed previously, and fixing them with the same screws as removed at the beginning.

3.2 Mounting single blower units on the wall / ceiling

The single blower units (P/N DLA%F) are designed to be installed on a vertical wall using a special metal support to be fixed to the wall using screws. Check that the wall is made from suitable material and is able to support the weight of the blower unit (concrete, not plasterboard).

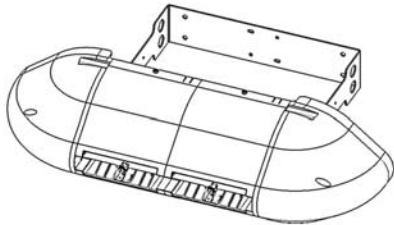

Fig. 3.b

First remove the blower unit from the packaging and take off the side plastic covers. Remove the blower unit from the steel bracket on the rear.

Rest the bracket against the wall in the position where the blower will be installed, and then drill four holes in the wall, using the steel bracket as the drilling template.

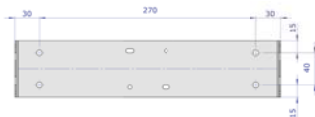

Fig. 3.c

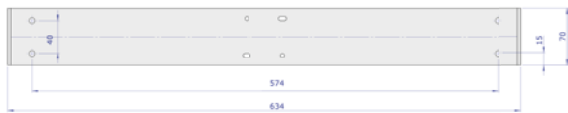

Fig. 3.d

After having drilled the holes in the wall, fix the metal support using anchor screws (not supplied).

Then attach the blower to the protrusions on the wall-mounting support bracket.

Fix the blower unit to the bracket using the screws supplied in a bag inside the packaging.

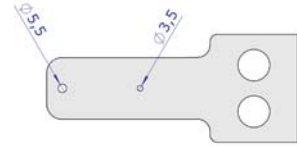

Fig. 3.e

When tightening the first screw (M6 self-tapping in $\text{Ø}=5.5$ mm holes), slightly loosen the screws on the ring clamps that support the nozzle manifold, so as to be able to turn it and free up space to continue mounting the unit. Tighten one screw on the right and one screw on the left.

Then tighten the third screw (M4 self-tapping in $\text{Ø}=3.5$ mm hole) on the right-hand side of the blower (opposite the terminal block). When tightening this screw, the angle of the blower can be adjusted between $-10^\circ/-5^\circ/0^\circ/+5^\circ/+10^\circ$ from horizontal, using one of the five small holes provided.

Then make the water connections, connecting the feedwater line either on the right or left of the blower, and the water return line on the opposite side.



Fig. 3.f

Finally, fit the two cable glands and complete the electrical wiring, as described in paragraph 3.4.

Carel also provides an additional kit (including a special plate bent at 90°) for mounting single blower units on the ceiling.

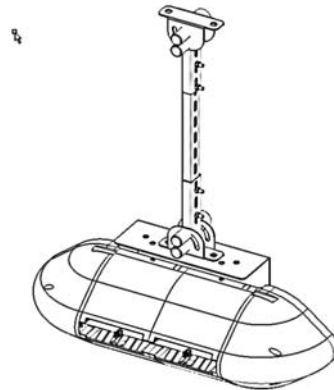

Fig. 3.g

3.3 Mounting double blower units on the ceiling

The double blower units (P/N DLA%B) are designed to be installed on the ceiling by anchoring them to a metal support that can support their weight and the vibrations due to the pressurised water. To mount the blower unit, use the special attachments provided on the unit's metal structure.

Carel provides additional kits with everything needed to complete installation easily. Make sure to carefully choose the point where the vertical support bar will be anchored. The support bar must not be longer than 1 metre, so as to avoid excessive bending and vibrations.

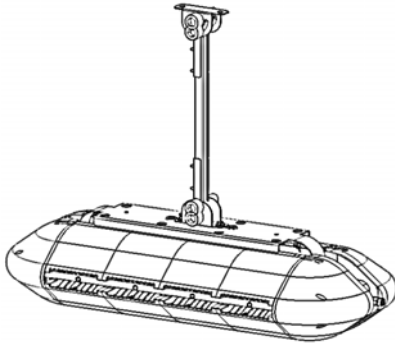

Fig. 3.h

After installing the blower, make the water connections by connecting the feedwater and return lines to the two pipes provided on the top of the blower. The feedwater/return lines can be connected either to the right or left.



Fig. 3.i

Finally, fit the two cable glands and complete the electrical wiring, as described in paragraph 3.4.

3.4 Blower unit electrical connection

The blower units must be electrically connected to the cabinet so that they are activated only when there is a humidification request

Before electrically connecting the blower units to the cabinet, make sure that the cable glands supplied with the cabinet and the blower units are available. All connections to be made by the user (cabinet power supply, blower unit power supply, probe connections, etc.) must be performed by running the cables through the cable glands, and in accordance with local safety standards.

Also check that the cable is the right size for the distance and voltages used. Carel recommends an AWG14 or AWG12 cable, as shown in the technical data at the end of the manual.

To connect power to the blower units, connect three suitably-sized wires (line + neutral + earth) from the terminals on the cabinet (shown in the figure) to the terminals on the blower (shown in the figure). To power a second and subsequent blowers, start from the free terminals on of the previous blower and connect to the terminals on the next blower, as shown in the figure.

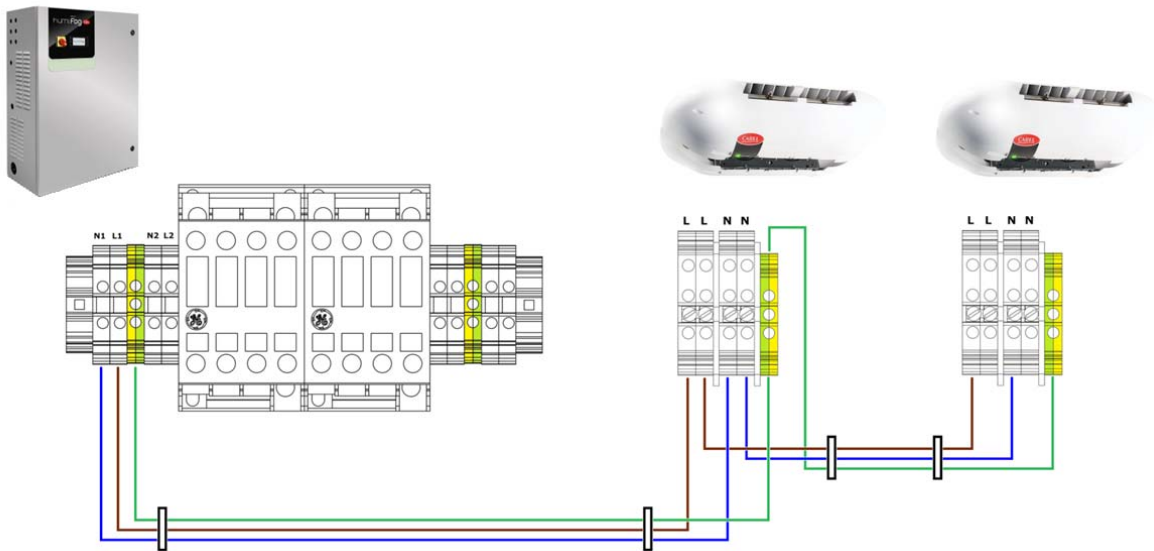

Fig. 3.j

Important:

- remember to run the wires through the cable glands (marked in the figure).
- check the maximum number of blower units that can be connected to each cabinet in the tables in Appendix 12 at the end of the manual.
- when connecting the line (L) and neutral (N) from the cabinet to the blower units, never reverse L and N. Reversing or crossing over the wiring may cause short-circuits.

After having completed the wiring, close the side plastic covers again and fix them using the screws. The system is now ready to operate.

4. ELECTRONIC CONTROLLER SET UP AND CONNECTIONS

After having correctly installed the cabinet and completed the water and electrical connections, connect the signals used to interface with the humiFog Direct humidifier to the c.pHC electronic controller (and the c.pCO controller on two-zone cabinets).



Fig. 4.a

4.1 Remote ON/OFF signal connection

The remote ON/OFF contact is used to enable operation from an external device. It is a digital contact that can be either open or closed: when the terminal is open, humiFog cannot operate. The contact refers to inputs 7 [GND]- 8 [digit] on terminal M2 on the c.pHC.

The remote ON/OFF contact must not be confused with the ON/OFF signal that manages operation, described in paragraph 4.5.

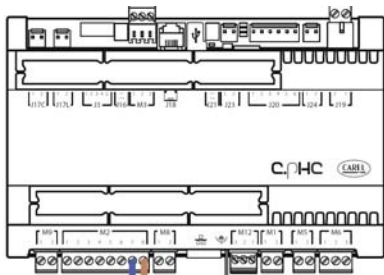

Fig. 4.b

If not intending to use an external contact to start / stop the unit, leave the terminal short-circuited (as supplied).

4.2 Analogue signal from the main probe and limit probe in the first zone

humiFog Direct can be controlled using an analogue signal (modulating) from a main humidity or temperature probe connected to the c.pHC electronic controller. If connected to a humidity probe, humiFog Direct will display the relative humidity read by the probe. If connected to a temperature probe, on the other hand, humiFog Direct will display the temperature. Based on the probe reading and the deviation from the set point, humiFog Direct will modulate the humidification load according to the PWM principle (see paragraph 6.5).

The following types of probes are allowed:

- 4-20 mA, 0-20 mA current probes
- 0-10 V, 0-1 V, 2-10 V voltage probes

The analogue signal from the main probe in the first zone is connected to the c.pHC controller via inputs 1 [IN a] 2 [GND] 3 [+12 Vdc] on terminal M2.

The limit probe (optional) is used for the auxiliary function to reduce humiFog Direct humidification or cooling capacity when approaching a set humidity or temperature threshold (on the display or external controller).

To set the threshold, select operation with limit probe on the display. The threshold will either be a humidity or temperature value. The limit probe can also be used without using a main probe.

The following types of probes are allowed:

- 4-20 mA, 0-20 mA current probes
- 0-10 V, 0-1 V, 2-10 V voltage probes

The analogue signal from the limit probe in the first zone is connected to the c.pHC controller via inputs 5 [IN a] 6 [GND] 3 [+12 Vdc] on terminal M2.

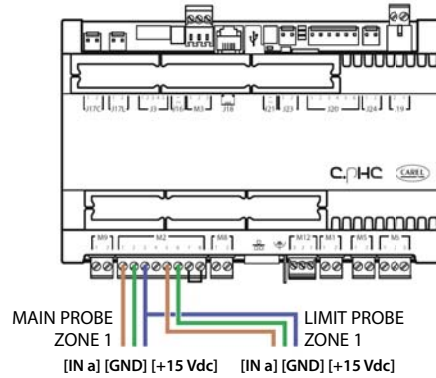

Fig. 4.c

Important: if connecting a probe with voltage signal that requires a power supply greater than the +12 Vdc supplied to the terminal on the c.pHC, the third wire must not be connected to input 3 [+12 Vdc] but rather to terminal GA1 [+24 Vac], made available on the cabinet terminal block, right above the c.pHC.

4.3 Analogue signal from the main probe and limit probe in the second zone

If a second zone is used (only with UA%DD200 and UA%DU200 cabinets), the main probe corresponding to the second zone must be connected to the c.pCOe expansion installed under the c.pHC controller.

The following types of probes are allowed:

- 4-20 mA, 0-20 mA current probes
- 0-10 V, 0-1 V, 2-10 V voltage probes

The inputs used for the main probe are U1 [IN a] and [GND] on terminal J2, and the power supply is taken from the +Vdc on terminal J9. The limit probe (optional) corresponding to the second zone is connected to inputs U2 [IN a] and [GND] on terminal J2, and the power supply is taken from the +Vdc on terminal J9.

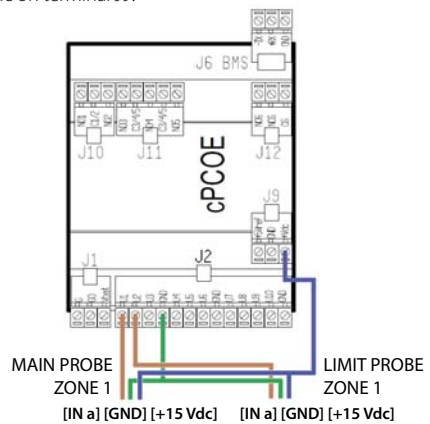

Fig. 4.d

Important: unlike the first zone, the connection to the c.pCOe expansion relating to the second zone can supply power to probes that require up to 21 Vdc.

4.4 Analogue signal from an external controller

As an alternative to the main probe, a signal from an external controller can be used. The latter processes the request to send to humiFog Direct via an analogue signal, which varies from 0 to 100%. humiFog will adjust the capacity delivered proportionally to the signal received, and the display will show the request sent as a percentage.

The following types of proportional signals are allowed:

- 4-20 mA, 0-20 mA current signals
- 0-10 V, 0-1 V, 2-10 V voltage signals

The external signal for the first zone is connected to the c.pHC controller via inputs 1 [IN a] and 2 [GND] on terminal M2.

The external signal for the second zone is connected to the c.pCOe controller via inputs U1 [IN a] and [GND] on the terminal J2.

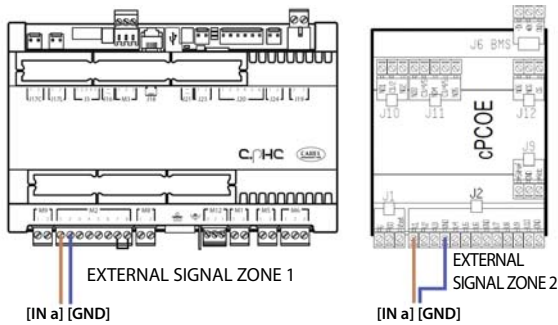

Fig. 4.e

Fig. 4.f

The limit probes can also be associated with the external proportional signal, and will be connected as shown in the previous paragraphs.

4.5 Digital signal from humidistat or external controller

The signal from the external controller can be replaced by the signal from a humidistat, thermostat, or any external device with digital contact. In this case, humiFog Direct will work in ON/OFF mode, either delivering 100% of flow-rate or remaining in standby. The capacity delivered can be reduced by setting parameter P0 (the reduction is managed by PWM, see paragraph 6.5).

The electrical connection is the same as in the previous case shown in Figure 4.e. Make sure to configure the humiFog Direct (via the screens on the display) so that it can be controlled by an ON/OFF signal from external controller or device.

4.6 Serial or Ethernet communication

humiFog Direct can be controlled by a supervisor that reads the humiFog Direct parameters and sends commands. To connect a supervisor, the RS485 serial port (terminal M12, inputs 1 [Tx/Rx-] 2 [Tx/Rx+] 3 [GND]) or Ethernet port is used. The choice of which port to use depends on the supervisor. Modbus and BACnet communication protocols are available as standard: no auxiliary cards need to be fitted on the c.pHC controller

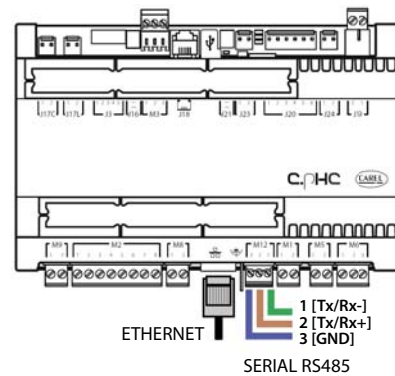

Fig. 4.g

The Ethernet port can also be used for the Webserver function (see Chapter 8), so as to monitor and control humiFog Direct via a local network, without needing a supervisor.

4.7 Alarm relay output

The digital output for communication of an alarm status is connected to contacts 1-2-3 on terminal M6 on the c.pHC. N.C. logic is set by connecting the two wires to contacts 1-2, while N.O. logic is set connecting the two wires to contacts 1-3.

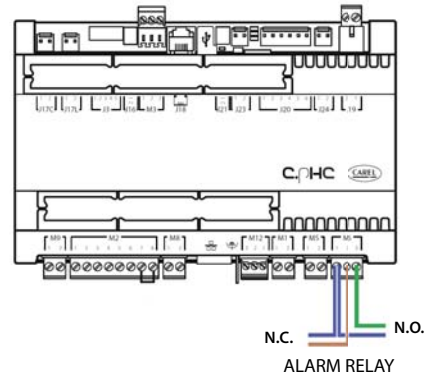

Fig. 4.h

4.8 Unit status digital output

The c.pHC controller provides a digital output corresponding to unit status. This is a voltage-free contact that provides the following information:

- contact closed: unit on or in standby
- contact open: unit off (OFF from keypad or from remote contact, or no power)

The unit status digital output is available at contacts 1-2 on terminal M5 on the c.pHC.

4.9 Production percentage analogue outputs

The c.pHC controller provides an analogue output (0-10 V) corresponding to the percentage of production that humiFog Direct is delivering. The output replicates the request signal relating to the corresponding humiFog Direct zone.

The production percentage analogue outputs are connected to the following terminals:

- zone 1: outputs 1 and 2 on terminal M8 on the c.pHC.
- zone 2: outputs U3 and GND on terminal J2 on the c.pCOe.

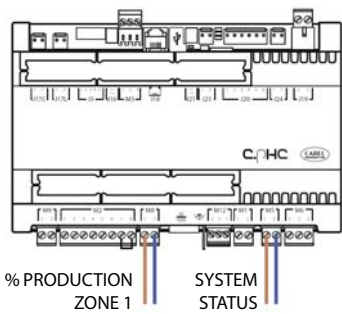

Fig. 4.i

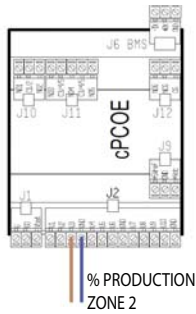

Fig. 4.j

Important: when several GND contacts are wired to the same terminal these are equivalent to each other, and can be used indifferently.

5. START-UP AND USER INTERFACE

Before starting the humidifier, check that the water and electrical connections have been completed in accordance with the instructions in chapters 2 and 3.

5.1 Start-up



Switch on humiFog Direct by moving the disconnect switch on the front panel from position O to position I.

The display shows the "humiFog Direct" logo, after which the menu language can be chosen, from the following options:

- English
- Italiano
- Deutsch
- Français
- Español

Scroll the languages using \uparrow or \downarrow , confirm by pressing ENTER. Then access the configuration wizard by pressing ENTER.

5.2 Keypad

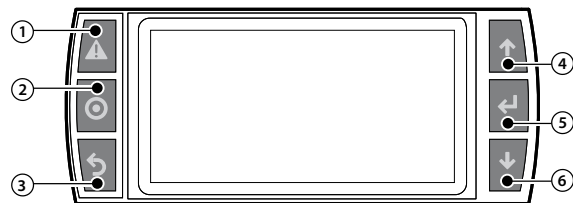

Fig. 5.a

Ref.	Button	Function
1	Alarm	List of active alarms, reset any active alarms and access the alarm log
2	PRG	Access the main menu
3	ESC	Return to previous screen. From the main screen access the notification centre
4	UP	Scroll cyclically around the main menu, parameters and parameter values. From the main screen, select the quick access menu
5	ENTER	Select and confirm From the main screen access the quick access menu
6	DOWN	Scroll cyclically around the main menu, parameters and parameter values. From the main screen, select the quick access menu

Tab. 5.a

5.3 Configuration wizard

The guided procedure (wizard) is used to configure the unit's main functions in a maximum of 9 steps.

Step 1/9

Enter the humidification load in kg/h relating to zone 1 and, if featured, relating to zone 2. The humidification load is easily calculable by multiplying the number of atomising nozzles in the zone by the flow-rate delivered by each individual nozzle.

Step 2/9

Select the control mode for zone 1 from the following options:

- ON/OFF contact (e.g. humidistat);
- external signal;
- external signal + limit humidity probe;
- external signal + limit temperature probe;
- main humidity probe;
- main temperature probe;

- main humidity probe+ limit humidity probe;
- main temperature probe+ limit temperature probe;
- main humidity probe + limit temperature probe;
- main temperature probe+ limit humidity probe;
- two main humidity probes (weighted average);
- two main temperature probes (weighted average).

Step 3/9

Select the control mode for zone 2. The options available are those listed for step 2/9.

Step 4/9

Select the type of signal from the main probe or the external controller for the control of zone 1:

- 0-10V
- 4-20mA
- 0-20mA
- 0-1V
- 2-10V
- NTC (temperature probe only)

Step 5/9

Select the type of signal arriving from the limit probe in zone 1. The signals available are those already listed in step 4/9.

Step 6/9

Select the type of signal arriving from the main probe or by external controller for the control of zone 2. The signals available are those already listed in step 4/9.

Step 7/9

Select the type of signal arriving from the limit probe in zone 2. The signals available are those already listed in step 4/9.

Step 8/9

Enter the set points for zone 1, corresponding to the main probe and the limit probe.

Step 9/9

Enter the set points for zone 2, corresponding to the main probe and the limit probe.

The wizard has now been completed: the user can choose whether to display it again the next time humiFog Direct is started. In any case, the wizard is always available on screen Df01.

5.4 Main screen

At the end of the guided configuration procedure, the display shows the main screen, divided into graphic areas.

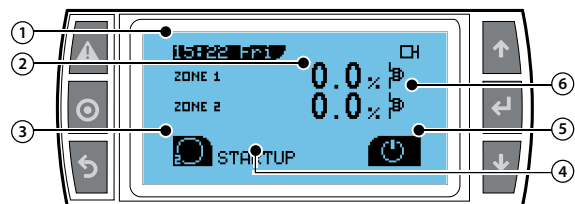

Fig. 5.b

Graphic area ref.	Description
1	Current time / day
2	Request / probe reading
3	Notification centre
4	Unit status
5	Quick access menu
6	Zone status icon

Tab. 5.b

5.5 Graphic area 2 – Request / Probe reading

This portion of the main screen displays the external request signal or the value measured by the main control probes for zone 1 and 2. If zone 2 is absent, only zone 1 is displayed, in full screen mode. The unit of measure indicated next to the value depends on the selected control mode.

Control mode	Unit of measure
External contact / external signal	%
Main humidity probe	%rh
Main temperature probe	°C

Tab. 5.c

5.6 Graphic area 3 – Notification centre

This portion of the main screen immediately shows the number of active notifications: for example, the screen illustrated in paragraph 5.4 shows two active notifications. To display these, access the notification centre by pressing ESC.

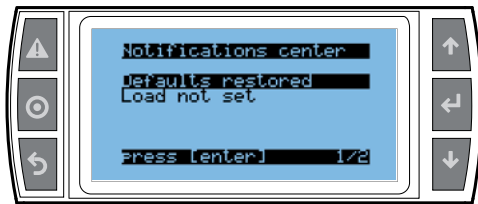

Fig. 5.c

Once having accessed the notification centre, the list of active notifications is displayed. Select the desired notification by pressing UP or DOWN and display the details by pressing ENTER.

Notification	Description
Default parameters restored	The default parameters have been restored from screen Df05 or Df06
Automatic start-up	The unit has commenced production automatically following a power failure
High temperature	The water temperature in the bypass has exceeded the threshold value due to extended recirculation
Low pressure	The cabinet feedwater pressure probe has measured a value that is less than minimum allowed limit: the water supply may have been shutoff
Wash completed	The unit has completed a washing cycle due to inactivity
1000 h maintenance	1000 operating hours elapsed, maintenance warning
3000 h maintenance	3000 operating hours elapsed, maintenance required
Load not set	The load for one or both zones has not been set in step 1/9 of the wizard
Limited network production	The network of humidifiers is not able to meet the load because one or more cabinets have an alarm or have been switched off by the user

Tab. 5.d

5.7 Graphic area 4 – Unit status

The message contained in this graphic area identifies the current unit status.

Unit status	Description
Start	Unit status on receiving the first production request signal after start-up; checking for feedwater and water pressure.
Wait	The unit is awaiting a request
Production	The unit is on and is delivering pressurised water to one or both zones
Alarm	There is at least one active alarm and the alarm button is on: press it to access the list of active alarms.
OFF from BMS	Production disabled by the supervisor
OFF from scheduler	Production disabled by time bands (scheduler)
OFF from remote	Production disabled by remote contact (voltage-free contact M2.7-M2.8 open)
OFF from keypad	Production disabled from the keypad
Wash	The unit is flushing water through the lines to wash the hoses
Filling	The unit is running water through the line to fill the hoses. Unit status when a production request is received and the line is empty.
Manual mode	The unit is managed in manual mode based on the controls sent on screens De01-De05
Backup ready	The unit is ready to start operating as backup for another unit on the network of cabinets (humidification capacity extended to a maximum of four single zone units)

Tab. 5.e

5.8 Graphic area 5 – Quick access menu

Using the arrows (↑ or ↓) and then pressing ENTER provides quick access to the following functions:

Paragraph	Icon	Meaning
5.8.1.		Unit ON/OFF
5.8.2		Set
5.8.3		Info

Tab. 5.f

5.8.1 Unit ON/OFF

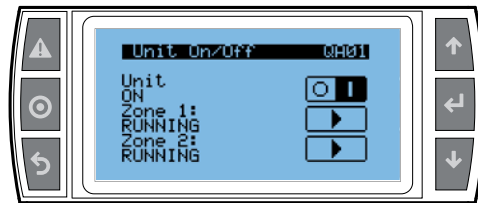

Fig. 5.d

Message	Value	Meaning
Unit	ON	Pump enabled for operation based on request for the zone
	OFF	Pumping unit switched OFF
Zone 1/2 (visible only if unit ON)	RUNNING	Atomisation allowed in zone 1/2 based on request
	PAUSED	Atomisation temporarily stopped in zone 1/2*

* This function is useful if needing to check and/or carry out maintenance on the blower units in one of the two zones: while the PAUSED zone is in standby, the RUNNING zone can continue atomising based on the request. As soon as the PAUSED zone is on again, it immediately restarts atomisation according to the request, without filling the water line.

- The unit is ready to start when the following conditions are all satisfied:
- the request from the external signal is greater than 10% or the humidity / temperature measured is less than the set point selected in steps 8/9 and 9/9 of the guided procedure;
 - the unit is in ON from the keypad and the zones are in RUNNING mode;
 - there an external signal that enables operation, i.e. the voltage-free contact between M2.7-M2.8 on the c.pHC controller is closed;
 - the unit is ON from scheduler (if enabled);
 - the unit is ON from the supervisor (if on/off from the supervisor via BMS or Ethernet port is enabled).

5.8.2 Set

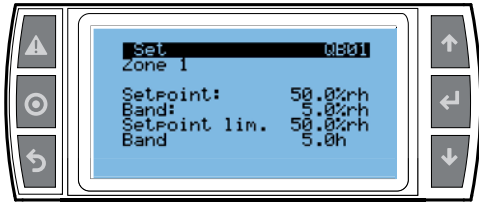

Fig. 5.e

The information on the Set screen depends on the selected control mode. When control by probe has been selected, this screen is used to set the zone humidity / temperature set point and the limit probe set point, if used. Each set point is associated with the amplitude of the proportional band inside which the unit modulates atomisation.

Example: set point = 50%rH and band = 5%rH means that atomisation in the room will be modulated starting from 45%rH.

Page	Title	Message	Value	Default
QB01	Set zone 1	Main probe set point	0-100%rh/ 0-40°C	50%rh / 25°C
(QB02)	(Set zone 2)	Main probe band	0-10%rh/ 0-10°C	5%rh / 2°C
		Limit probe set point	0-100%rh/ 0-40°C	80%rh / 15°C
		Limit probe band	0-10%rh/ 0-10°C	5%rh / 2°C

Tab. 5.g

5.8.3 Info menu

This is a read-only menu set out into different screens that display the main data on the humiFog Direct unit.

Page	Message	Value/notes
QC01	Unit ON	Yes/No
	Status	as per Ref. 4 on main screen
	Request	0-100%
	Production	0-80 kg/h
QC02	Maintenance hour counter	resettable
	Unit hour counter	not resettable
QC03	Current date and time	dd/mm/yy ; h:min:s
	Date and time of last shutdown	dd/mm/yy ; h:min:s
	Time since last shutdown	days ; hours ; min
	Expansion online	Yes/No
QC04*	Expansion firmware version	
QC05	Model	
	Power supply	115/230 V
	Phases	1
	Power supply frequency	50/60 Hz
	Pump rated production	40/80 kg/h
	No. of zones	1 or 2
QC06	SW version	
	OS version	
	Boot version	

Tab. 5.h

*Screen QC04 is only displayed if the second zone is used..

5.9 Graphic area 6 – Zone status icon

The symbol displayed in this graphic area identifies the status of the zone. Important: in general, the zone status is different from the unit status.

Icon	Meaning
	The zone is in standby or off
	The zone is atomising
	The zone has stopped due to an alarm
	The zone is temporarily disabled

Tab. 5.i

5.10 Alarms

If there are active alarms, these are shown on the corresponding screen, accessible by pressing the dedicated button (triangle with exclamation mark).

The ALARM button starts flashing when an alarm occurs: pressing the button once displays the type of alarm.

The alarms are divided into three categories:

- potentially dangerous alarms that automatically stop production, forcing the unit off until they are reset (alarm code AB***);
- signals that do not stop production (alarm code AL***);
- warnings only logged in the notification centre, neither signals nor alarms that stop production (alarm code WR***).

For some alarm events, together with the signal the alarm relay is activated. When the cause of the alarm is no longer present:

- the humidifier and the alarm relay are reset, either automatically or manually (see Chap. 7.1 "Alarm List");
- the message displayed can only be cleared manually

Even if no longer active, the alarm status will continue to be shown until the "reset display" button is pressed. Alarms that are still active cannot be reset. If more than one alarm is active, the display indicates all of these in sequence. From the alarm screens the log can be displayed by pressing ENTER. For the complete table of alarms see chap. 10 "Alarm table".

6. OPERATION OPTIONS

6.1 Main menu and overview of functions

Access the main menu by pressing PRG. This menu lists a number of submenus, where all the unit parameters can be read and set if necessary. Each submenu is divided into a number of screens identified by the index shown at the top right on the display. The table below provides a complete overview of the screens.

Menu		Index	Description
A. Clock	Change time and data	A01	Set date, time and date format
		B01	Enable time bands
B. Scheduler	Scheduler	B02	<i>(visible if time bands are enabled)</i> Time band setting: day, ON time, OFF time
		C01	Read water probes: feedwater pressure, outlet pressure, bypass temperature
C. Inputs/Outputs	Analogue inputs	C02	Read control probes: main zone 1, limit zone 1, main zone 2, limit zone 2
	Digital inputs	C03	Read digital inputs
	Analogue outputs	C04	Read production request [%] for zone 1 and for zone 2
	Unit digital outputs	C05	Read status of contactor, fill valve (feedwater), drain valve (cabinet), bypass drain valve
	Digital outputs, zone 1	C06	Read status of fill (outlet) and drain valve (return) for zone 1, fan status in zone 1
	Digital outputs, zone 2	C07	Read status of fill (outlet) and drain valve (return) for zone 2, fan status in zone 2
	Unit digital outputs	C08	Read unit status contact, alarm relay, cabinet fan enabling contact, external water treatment system enabling contact
	a. Control		Da01
Da02			Set type of control in zone 2 and maximum production
Da03			<i>(visible if control using two main probes is enabled)</i> Weight of control probes in zone 1
Da04			Set point and band for the main probe in zone 1
Da05			Set point and band for the limit probe in zone 1
Da06			<i>(visible if control using two main probes is enabled)</i> Weight of control probes in zone 2
Da07			Set point and band for the main probe in zone 2
Da08			Set point and band for the limit probe in zone 2
Da09			Maintenance hour counter, reset hour counter and set maintenance warning
Da10			Displayed after 40 hours of operation Possibility to reset the oil change hour counter <i>(warning activated after 50 h)</i>
Da11			Unit hour counter, not resettable
Da12			Unit hour settings (e.g. after replacing c.pHC controller) and maintenance warning
b. Functions		Db01	Enable filling and set fil duration
		Db02	Set wash duration and frequency
		Db03	Enable management of external water treatment system
		Db04	Manage blower fan delay at unit start-up and shutdown
		Db05	Export event log
		Db06	Export alarm log
c. Configuration		Dc01	Set type of signal from the main humidity probe in zone 1, minimum/maximum probe reading, probe offset, enable probe disconnected alarm and delay associated with the alarm
		Dc02	Set type of signal from the main temperature probe in zone 1, minimum/maximum probe reading, probe offset, enable probe disconnected alarm and delay associated with the alarm
		Dc03	Set type of external signal for zone 1, minimum/maximum signal, signal offset
		Dc04	Set N.O./N.C. logic for the control on/off external contact (humidistat)
		Dc05	Set type of signal from the limit humidity probe in zone 1, minimum/maximum probe reading, probe offset, enable probe disconnected alarm and delay associated with the alarm
		Dc06	Set type of signal from the limit temperature probe in zone 1, minimum/maximum probe reading, probe offset, enable probe disconnected alarm and delay associated with the alarm
		Dc07	Set type of signal from the main humidity probe in zone 2, minimum/maximum probe reading, probe offset, enable probe disconnected alarm and delay associated with the alarm
		Dc08	Set type of signal from the main temperature probe in zone 2, minimum/maximum probe reading, probe offset, enable probe disconnected alarm and delay associated with the alarm
		Dc09	Set type of external signal for zone 2, minimum/maximum signal, signal offset
		Dc10	Set N.O./N.C. logic for the control on/off external contact (thermostat)
		Dc11	Set type of signal from the limit humidity probe in zone 2, minimum/maximum probe reading, probe offset, enable probe disconnected alarm and delay associated with the alarm
		Dc12	Set type of signal from the limit temperature probe in zone 2, minimum/maximum probe reading, probe offset, enable probe disconnected alarm and delay associated with the alarm
		Dc13	Set wireless probes 1-4: main, limit or absent
		Dc14	Set wireless probes 5-8: main, limit or absent
		Dc15	Enable wireless probes 1-4 for the main control/limit function in zone 1/2
		Dc16	Enable wireless probes 5-8 for the main control/limit function in zone 1/2
		Dc17	Weight [%] of the wireless probes
		Dc18	Humidification load in zone 1/2
Dc19	Set delay in opening and closing the drain valve in zone 1		
Dc20	Set delay in opening and closing the drain valve in zone 2		
Dc21	Bypass valve opening delay from drain valve opening		
d. Network		Dd01	Enable network of humidifiers by Prg button <i>(if enabled, the network symbol is displayed at the top right of the main screen)</i>
		Dd02	IP address setting of cabinet 1/2/3/4 in the network and check online/offline status
		Dd03	Set maximum load and set grouped/balanced distribution
		Dd04	Set rotation time (0 h = rotation disabled)
		Dd05	Unit offline alarm timeout

Menu	Index	Description	
D. Settings (password_...)	d. Network	Dd06	Disable network settings for the current unit (if Y, the network symbol disappears from the top right on the main screen)
		Dd07	Current unit request and production
		Dd08	Check status and [%] production of unit 1/2/3/4 in the network
	e. Manual mode	De01	Enable manual zone request, set request [%] and enable management of individual outputs on the c.pHC to check function of electromechanical components
		De02	Manual management of contactor, fill valve (FV), cabinet drain valve, bypass valve
		De03	Manual management of fill valve in zone 1, drain valve in zone 1, fans in zone 1, set production [%] for zone 1
		De04	Manual management of fill valve in zone 2, drain valve in zone 2, fans in zone 2, set production [%] for zone 2
		De05	Manual management of unit status contact, alarm relay, fan on cabinet, WTS contact
	f. Initialisation	Df01	Access configuration wizard and enable/disable wizard at power-on
		Df02	Set screen language
		Df03	Change password to access menu "D. Settings"
		Df04	Set units of measure, international/Imperial
		Df05	Set unit model
		Df06	Restore default parameters
		Df07	Enable USB port reading to update unit software
	g. Supervision	Dg01	Serial address setting, enable unit on/off and control from the supervisor
		Dg02	Select supervisor protocol
		Dg03	BMS supervision port configuration: baud rate, stop bits, parity
		Dg04	Ethernet supervision port configuration: DHCP, IP address, mask, gateway, DNS. Important: these values must be supplied by the local network administrator
		Dg05	BACnet configuration: address, maximum no. of masters, maximum no. of frames
	h. Logout		Exit menu "D. Settings": password must be entered on next access

Tab. 6.a

6.2 Scheduler

The Scheduler menu enables operation based on time bands.

Index	Description	Parameter
B01	Scheduler	Enable time bands Default: time bands disabled

To configure the humidifier operating time bands for a specific day (24h), use screen B02 (visible only if the scheduler is enabled). A time band can be set with production disabled (OFF) or enabled (ON). Setting the ON time band, the unit uses the main set point configured on screen Qb01.

Index	Description	Parameter
B02	Scheduler	Define daily and weekly time bands

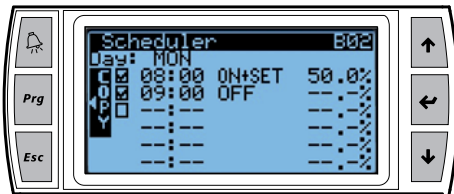

Fig. 6.a

In the example shown here in Fig.7.a, the time band from 8.00 to 9.00 is enabled for production. After 9.00, the humidifier will not be enabled.

unit of measure indication:	symbol displayed	Unit of measure
	%	%rH
	°C	Degrees Celsius
	°F	Degrees Fahrenheit

Once the time bands have been defined for one day, press **Prg** to copy the currently displayed bands (daily) to the next day. When the time bands have been set, the display shows the ☹️ symbol.

6.3 Proportional control to an external signal (modulating operation)

Atomisation is proportional to the value of an external signal Y, (selectable from the following options: 0 to 1 Vdc; 0 to 10 Vdc; 2 to 10 Vdc; 0 to 20 mA; 4 to 20 mA). The maximum production Pmax corresponds to the maximum value of the external signal Y, and will be the humidifier's rated production. The activation hysteresis hy is not settable by the user.

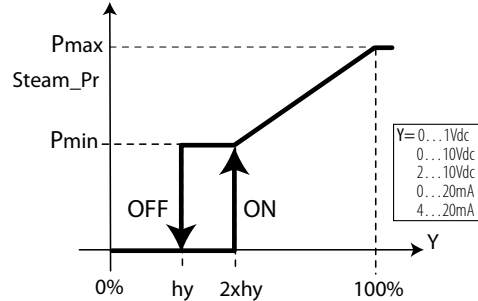

Fig. 6.b

Key:

Water_pr	Pressurised water production	Y	External signal
P0	Max production	hy	Activation hysteresis
Pm	Min production		

6.4 Autonomous control with humidity probes

When using a main humidity control probe and an optional limit humidity probe, atomisation is related to the % rH reading made by the relative humidity probe and increases as the value read deviates from the set point St. Maximum production Pmax corresponds to the case where the humidity value, read by the probe, is BP away (proportional band) from the set point. The activation hysteresis hy is not settable by the user.

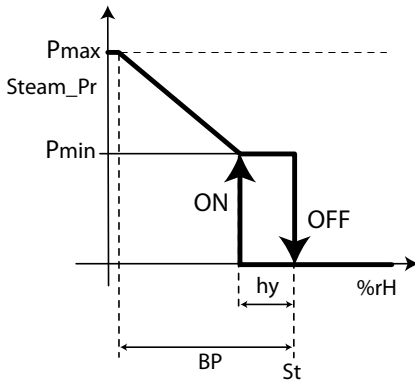

Fig. 6.c

Key:

Water_pr	Pressurised water production	Y	External signal
P0	Max production	hy	Activation hysteresis
Pm	Min production		

When using a main temperature control probe and an optional limit temperature probe, atomisation is related to the temperature reading in °C or °F made by the probe and increases as the value read deviates from the set point St. Maximum production Pmax corresponds to the case where the temperature value, read by the probe, is BP away (proportional band) from the set point. The activation hysteresis hy is not settable by the user.

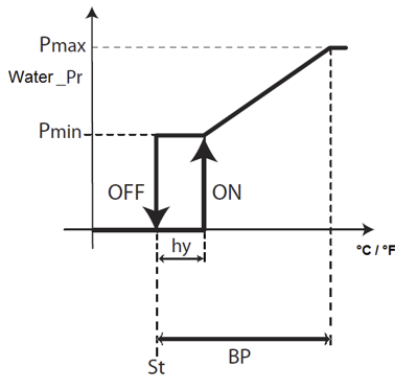

Fig. 6.d

Key:

Water_pr	Pressurised water production	Y	External signal
P0	Max production	hy	Activation hysteresis
Pm	Min production		

For "humidity (one probe)" or "temperature (one probe)" control, one single main probe can be connected and configured, either wired or wireless.

For "humidity with limit" or "temperature with limit" control, a wired probe can be connected as the main probe and a wired probe as the limit. If using wireless probes (maximum of four), two groups of probes can be defined: the group of main probes and the group of limit probes. In this case, the average will be calculated between the main probes, depending on the defined weight, and the limit probes will also have their own average, again depending on the defined weight.

For "humidity (two probes)" or "temperature (two probes)" control, only a group of main probes can be defined. Wired probes can be connected to the main probe input (M2.1) and the limit probe input (M2.5), which will be used as a second probe, with the average calculated. If using wireless probes (maximum of four), only a group of main probes can be defined, with the average calculated, depending on the defined weight.

For the connections of the signals and/or probes, see chap. 4.

6.4.1 Weighted average of the probes (installer menu)

If using two temperature probes or two humidity probes, the humidifier controller will calculate the weighted average of the probe readings. In this way, two probes can be used, for example humidity probes, at opposite ends of the room, calculating the average.

Index	Description	Parameter
Ea02	Weight of the probes	Set the weight of the probes Default: 100 Possible settings: 0 to 100 Step: 1

The weight of each probe should be expressed with a value from 0 to 100.

The weighted average is calculated as follows:

$$\text{Weighted average} = \frac{(S1 \times p1) + (S2 \times p2)}{(p1 + p2)}$$

where "Si" is the probe reading, and "pi" the relative weight.

To calculate the arithmetic average, equal weights should be set (for example: p1 = p2 = 100).

6.5 Modulation of production

The system modulates the atomisation of water intermittently, in PWM mode (pulse width modulation). Within a time period of 120 seconds (settable value), the unit will deliver pressurised water to the blower units for atomisation by the nozzles in the room:

- for 120 seconds continuously, when there is maximum production request;
- for a fraction of time Ton less than 120 seconds (minimum 8% of the entire period) and proportional to the request signal, if not at the maximum.

When atomisation stops, the pump remains active and the water is recirculated through an internal bypass circuit in the pumping unit, rather than being delivered to the blower units.

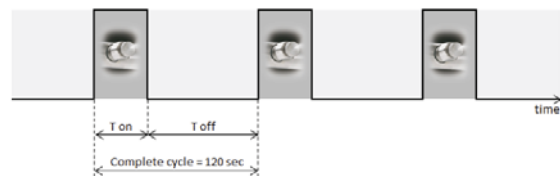

Fig. 6.e

7. MASTER/SLAVE NETWORK OF HUMIDIFIERS

7.1 Description of the Master/Slave system

To extend humidification capacity in an individual zone, several humidifiers can be connected together in a Master/Slave system. For example, if humidification request is 160 kg/h, a Master/Slave system can be created with two 80 kg/h humiFog Direct units.

A maximum of 3 Slave units can be connected to a Master, meaning a total of 4 humidifiers in the same system.

The Master and Slave units are connected using a local Ethernet network, and in the case of just two units (one Master and Slave) involves a direct connection between the two unit controllers via Ethernet RJ45 Category 5 cable.



Fig. 7.a

If the Master/Slave system comprises three or more units (maximum 4), a network switch is required.



Fig. 7.b

7.2 Network switch for Master/Slave connection

The Master/Slave connection of more than two units requires the use of an industrial grade switch.

Carel markets a switch (P/N: KITSE08000) that can connect a maximum of eight units (8 Ethernet ports). If necessary, use several KITSE08000 switches with a cascaded arrangement.

Main technical specifications of the KITSE08000 switch:

Number of ports	8
Installation	DIN rail
Operating temperature	-10 to 60°C (14-140°F)
Power supply	12/24/48 VDC
	18-30 VAC (47-63Hz)
Current @24VDC	0.13A
Protection	IP30

7.3 Type of Master/Slave system installation

The Master/Slave system features one main unit (Master), which manages operation of the secondary units (Slaves). The external signal or probe connections, depending on the set control type, are made to just one of the humidifiers in the system. The unit that the signal is connected to will automatically be identified as the Master. Consequently, the Master does not need to be especially configured.



The Ethernet port is available on the humidifier's c.pHC controller:

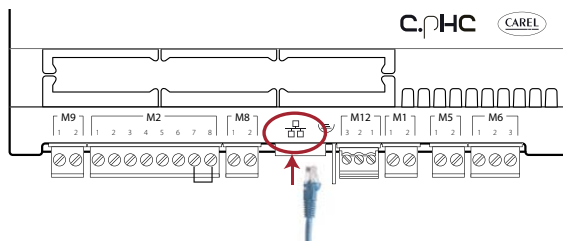

Fig. 7.c

Note: use Ethernet CAT-5 STP cable, maximum length 100 m. To connect the shield, use the earth connector provided on the controller.

While the Master unit is powered on, the system will be able to operate even in the event of malfunctions on the Master (alarms, stopped production,...), as the unit's controller will send all the required data to the Slaves. Obviously, unless redundancy has been factored into the total production capacity, atomised water output in this case will be lower than requirements.

If the Master is switched off completely, the Master/Slave system will not be able to read the control/probe signals. Consequently, it is suggested to connect all the humidifiers in the system (or at least two units) to the external signal or fit them with independent probes.

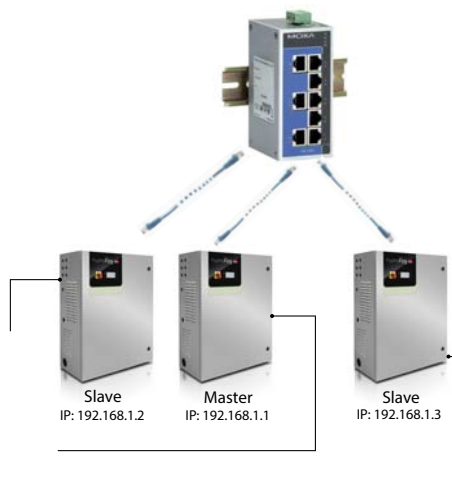

Fig. 7.d

Systems set up in this way will be able to cover the humidification requirement. In this specific case, the Master will always be the unit with the lowest IP address of those connected to the signal/probes. If necessary, an additional humidifier (backup) can be installed to cover request in the event of malfunctions on one of the units in the system.

7.4 Master/Slave system configuration

To configure the Master/Slave system, proceed as follows:

1. Connect the probes or the external signal to the unit and complete the configuration (control type, type of signal, maximum production ...);
2. Set the IP addresses of the individual units so that they belong to the same subnetwork (subnet mask); the screen index for this configuration is Dg04 (D. Settings – g. Supervision). The IP address is set on the display on each unit, assigning a different address to each unit in the same subnetwork. If necessary, contact the local network administrator. Remember that the default address for each unit is 192.168.0.1, and the default subnet mask is 255.255.255.0. For further details see paragraph 8.1.1 "IP address and network configuration"
3. Connect the units making up the Master/Slave system to the local Ethernet network via a switch. If using just two units, an RJ45 category 5 cable can be used, connected directly to the Ethernet ports on the two c.pHC controllers.
4. Configure the Master/Slave system by enabling the units one at a time (this operation can be performed on the display on any of the units):
 - 4.1 Display screen index Dd01 and then access configuration mode by pressing "PRG".
 - 4.2 Enter the IP address for "Unit 1" and confirm by pressing "ENTER".
 - 4.3 Repeat the operations described above (4.1 and 4.2) for all the other units in the Master/Slave system.
(The units will join the Master/Slave system (online) immediately after being added to the network.)

Note: the Master unit will always (automatically) be the one with the lowest IP address out of the units connected to the probes or external signal.

Note: it may take a few seconds (max 10 s) for the Master to start sending the production request to the Slave/Slaves. This is also true when, automatically, the Master unit is changed (for example, in the event of malfunctions).

7.4.1 Maximum Master/Slave system production

In the same way as for the individual unit configuration, for the Master/Slave system the maximum capacity can also be set. To set the maximum capacity, go to menu Dd03. The "Capacity" parameter identifies the maximum production request for the Master/Slave system, and can therefore be set by the user.

The "Maximum capacity" parameter (read-only), on the other hand, indicates the sum of the sizes of each unit added to the system; this value is therefore the maximum effectively available to the Master/Slave system. Consequently, "Capacity" will always be \leq "Maximum capacity". In any case, the maximum production can be defined for each individual unit in the system by limiting production from its maximum according to the size. In this case, "Maximum capacity" will be updated keeping in consideration these reductions.

7.4.2 Unit production distribution logic in the Master/Slave system

The activation logic of the units in the Master/Slave system can be set, choosing between "Grouped" or "Balanced", on screen Dd03.

Grouped distribution

- the units are activated in series, one after the other, according to the request.

Example: M/S system comprising two 80 kg/h units, for a maximum total capacity of 160 kg/h. While the request remains below 50% (80 kg/h) only one unit will be activated (for example, Unit 1), as soon as the request exceeds the 50%, the second unit will also be activated (in the example, Unit 2).

Balanced distribution:

- the units are activated in parallel at the same time, splitting the total production request between the number of units in the M/S system.

Example: M/S system comprising two 80 kg/h units, for a maximum total capacity of 160 kg/h. If the request is 50%, both Unit 1 and Unit 2 will be activated at 50% of production (40 kg/h + 40 kg/h = 80 kg/h). If the request is 90% (144 kg/h), both Unit 1 and Unit 2 will be activated at 90% (72 kg/h + 72 kg/h = 144 kg/h).

For Grouped Distribution only, if the request does not require the use of all the units, the automatic rotation function can ensure that the individual units total the same number of operating hours. To enable and configure the operating hours for unit rotation, set the "auto-rotation time" parameter on screen Dd04.

Note: if the "auto-rotation time" parameter is = 0, the auto-rotation function is disabled.

7.4.3 Disconnect unit from the Master/Slave system

To remove a unit from the Master/Slave system, thus reducing the number of units available in the system, use the "Disconnect unit" function on screen Dd06. This can be done on any of the humidifiers in the system.

Note: once the unit has been disconnected, this will no longer be visible in the Master/Slave system, as its IP address will be removed from the list. If a unit is disconnected erroneously, the system can be restored on screen Dd01 (entering its IP). This must be done from the display on a unit that is already connected to the system.

7.4.4 Display Master/Slave system

To display a summary of the Master/Slave system, go to screen Dd08. The menu displays all the units (01, 02, ...), the status of each unit and current production as a percentage. The following table lists the Master/Slave network unit status indications:

Symbol	Unit status in the Master/Slave system
	Indicates the current unit being displayed (PGD or web server)
	The unit is: online
	The unit is: offline
	Unit not configured and not included in the Master/Slave system

CAREL

The units in the Master/Slave system can also be selected one by one, displaying maximum production, unit status, operating hours, current production request and any alarms.

To enter this display, from screen Dd08, select the desired unit and press



, thus accessing screen Dd09. Scroll using the UP/DOWN buttons to display the details of all the units.

7.4.5 Software backup function in the Master/Slave system

Master/Slave mode can also be used to manage the software backup function; if one or more units in the Master/Slave system is affected by a malfunction, the system automatically restores humidification production by activating the backup units. The lost production in relation to the request is thus compensated by increasing production on the individual units (where possible) and/or starting any units in standby.

Even if not strictly necessary, to ensure the backup function, the external control signal must be sent to all the units in the Master/Slave system; if using probes on the other hand, each unit must be fitted with a probe. Only in this way can complete operation be guaranteed in the event of malfunctions.



Note: if a unit goes offline due to a malfunction or shutdown, it will temporarily be excluded from the system, and when next restarted it may take 15 seconds or more to automatically come online again.

7.4.6 Advanced backup functions (software) for maintenance

During maintenance or cleaning on a unit in the Master/Slave system, the backup function can be disabled for maintenance. This allows production to start on a unit in standby, set as backup, before switching off the humidifier in question for maintenance. In this way, service continuity can be guaranteed in applications where required humidity control is very precise and continuous over time.

To activate backup for maintenance, proceed as follows:

1. Enter the menu with screen index Dd07 (Network)
 2. Press the DOWN button to display the list of units (Dd08)
 3. Scroll to the unit on which maintenance is required (Unit 1, Unit 2, ...)
- and press  confirm (screen Dd09).
4. Press **Prg** to access screen Dd10 and set "Request switch unit off" = YES. Wait for the display to show the message: "The unit can now be switched off for maintenance" and then switch the unit off.

Once maintenance has been completed, simply switch the humidifier on again, and it will automatically come back online.



Note: to activate the advanced software backup functions for maintenance, the backup unit must be connected to the probes or external signal.

8. CONNECTIVITY

8.1 Webservice

The web server is a very interesting function when the user has a local network available that humiFog Direct can be connected to. The physical local network connection uses the Ethernet port with RJ45 connector on the humidifier controller (see Figure 4.G) and a normal Ethernet cable (category 5).

The integrated web server on the humiFog Direct c.pHC controller is used to configure and monitor the main unit parameters directly from a PC, tablet or smartphone.

In fact, using the Ethernet port on the humidifier controller, the humiFog Direct unit can be accessed via a local network by simply entering its IP address in the browser (Google Chrome, Internet Explorer, or others).

8.1.1 IP address and network configuration

An IP address is a numerical code that identifies the modem, computer, smartphone or any other device connected to a network, so as that these can communicate with one another. Typically the IP address of multiple devices connected to the same network is identical, except for a few numbers.

EXAMPLE:

- 192.168.1.1 device #1 connected to the network
- 192.168.1.2 device #2 connected to the same network
- 192.168.2.25 device #3 connected to the same network

Remember that when wanting to connect several devices to the same network, a switch is required (this can be supplied by Carel, P/N KITSE08000).

The IP address of the humiFog Direct unit is shown on the display, under:

- D. Settings
- d. Unit networks
- g. Supervisor

Dg04. Ethernet supervision port configuration: DHCP and IP address

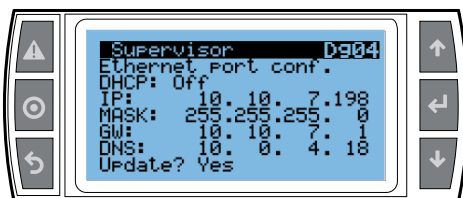

Fig. 8.a

Simply copy the numerical code (10.10.7.198 in the example in Figure 8.a) into internet address bar to access the humidifier's web server.

IP addresses may be :

- dynamic (if using the DHCP function that automatically assigns an IP address when a device is connected)
- static (if there is no DHCP function or it cannot be used, with manual assignment of the IP address directly by the user).

If using a dynamic IP address via the DHCP function on the server, DHCP needs to be enabled on screen Dg04 on the humiFog Direct unit. The IP address shown on the screen will be assigned automatically. The advantage of this feature is that the server and humiFog Direct communicate directly, and there is no need to configure the network parameters (subnet mask and gateway). The disadvantage is that if adding other devices to the same network with humiFog Direct off and not connected, the IP address originally assigned to the unit may change, and therefore the new address needs to be set on screen Dg04 and copied into the browser's address bar.

With a static IP address (with DHCP OFF as by default), on screen Dg04 enter the network parameters manually, as provided by the local network installer. Usually subnet mask and gateway have predefined values (which must be known), while the IP address can be assigned sequentially in relation to another device connected to the same network.

The default network configurations for the c.pHC are:

- unit IP address: 192.168.0.1
- subnet mask: 255.255.255.0
- gateway: 192.168.0.1

Important: in the "capacity extension" function (described in paragraph 6.4), DHCP cannot be activated, otherwise the units would not be able to communicate together. DHCP must be disabled on screen Dg04 (as by default).

Important: the controller is not accessible directly via the internet as a firewall guarantees remote access only over a secure connection (Carel tERA cloud connection). Consequently, outside of the local network the controller cannot be accessed, even if the network administrator assigns a public address.

8.1.2 Web server functions

Once having entered the web server, the login to access the various menu items requires the installer or service password (default 0077). The web server "home" provides direct access to a virtual display, allowing all the settings to be made in the same way as directly on the unit's actual display. In addition, an immediate response in terms of unit operation will be available on the interface overview. The following menus are available on the interface:

UNIT:

- Probes: information on the probe readings and the main and limit probe configuration. Select the type of signal and define the minimum and maximum values.
- Wireless: enable and associate each wireless probe to the group of main probes or limit probes. Read humidity and/or temperature, wireless probe signal level and battery charge.
- Control: select the type of control. Set the set point, differential and minimum / maximum.
- Scheduler: enable and set the daily and weekly time bands

NETWORK:

- Display a summary of the status of the units in the Master/Slave system.

MAINTENANCE

- Timers: display unit operating hours. Display time remaining until maintenance and set maintenance pre-alert.
- Logs: display the log of main variables (production, set point, pump status, request, unit status).
- Live: display the main variables in real time (production, set point, pump status, request, unit status).

INFO

- Unit info: information on the unit model and software version. Select language and unit of measure.
- Resources: useful links (Carel website, manuals and humiFog Direct page on the Carel website).
- Guide & FAQ: general information on using the web server.

Important: to avoid unwanted modifications, some of the main operating and unit parameters can only be set on the web server when the unit is off (off from keypad, settable on the web server).

8.2 Supervisor connection

The supervisor connection uses the serial or Ethernet port (as described in paragraph 4.6). The default communication settings are Modbus on serial port and BACnet on Ethernet port.

If connecting to the serial port, enable the chosen protocol (Modbus or BACnet) on the screens. For Modbus protocol only, set the baud rate/stop bits/parity. The default values (baud rate: 19000 / 2 stop bits / no parity) should work in almost all cases, unless otherwise specified by the supervisor network installer.

If connecting via Ethernet, follow the procedure (described in paragraph 8.1.1) to look up the unit's IP address, then establish whether the communication protocol will be BACnet and/or Modbus.

Important: if using BACnet protocol on a serial port, it cannot be used on the Ethernet port (and vice-versa). The Modbus protocol can on the other hand be used at the same time on both ports.

For all other information, see the manual for the supervisor used and/or contact the supervisor network manager.

8.3 List of Modbus parameters

Type	Section	Address	Parameter	Variable	Size		
Discrete inputs	Unit status	1	Unit on/off	UnitOn	1		
	Alarms	2	Circuit breaker intervention	Al_CircBreaker.Active	1		
		3	High pressure switch intervention	Al_HiPSwitch.Active	1		
		4	High pressure	Al_HiP.Active	1		
		5	Low pressure	Al_LoP.Active	1		
		6	High pressure on bypass	Al_HiPByPassBlk.Active	1		
		7	High pressure on bypass	Al_HiPByPass.Active	1		
		8	High temperature on bypass	Al_HiTByPassBlk.Active	1		
		9	High temperature on bypass	Al_HiTByPass.Active	1		
		10	Low pressure on bypass	Al_LoPByPass.Active	1		
		11	Zone drain valves error	Al_Drain.Active	1		
		12	Expansion offline	Al_ExpOffline.Active	1		
		13	Warning high temperature on bypass	Wr_HiTByPass.Active	1		
		14	Retain memory error	Al_Retain.Active	1		
		15	Retain memory writes error	Al_RetainWrite.Active	1		
		16	Main probe 1 error	Al_MainPrb_1.Active	1		
		17	Limit probe 1 error	Al_LimPrb_1.Active	1		
		18	Main probe 2 error	Al_MainPrb_2.Active	1		
		19	Limit probe 2 error	Al_LimPrb_2.Active	1		
		20	Low pressure trasducer error	Al_PressByPass.Active	1		
		21	Bypass temperature probe error	Al_TempByPass.Active	1		
		22	High pressure transducer error	Al_Press.Active	1		
		23	Missing model	Al_MissModel.Active	1		
		24	Water treatment system alarm	Al_WTS.Active	1		
		25 - 32	Wireless probe offline 1 - 8	Al_WPrb_1÷8.Active	1		
		33	Main probe 1 from wireless error	Al_WPrbMain_1.Active	1		
		34	Limit probe 1 from wireless error	Al_WPrbLim_1.Active	1		
		35	Main probe 2 from wireless error	Al_WPrbMain_2.Active	1		
		36	Limit probe 2 from wireless error	Al_WPrbLim_2.Active	1		
		37 - 40	Unit 1 - 4 alarm	Al_NetUnit_1÷4.Active	1		
		41	Change oil	Al_Maint_50.Active	1		
		42	Maintenance	Wr_Maint_1000.Active	1		
		43	Maintenance required	Al_Maint_3000.Active	1		
		Input registers	Unit status	1	Unit status	UnitStatus	1
				2	Request zone 1	ReqMsk_1	2
				4	Request zone 2	ReqMsk_2	2
				6	Production zone 1	Prod_1	2
				8	Production zone 2	Prod_2	2
				10	Water consumption 1	WProd_1	2
				12	Water consumption 2	WProd_2	2
				Inputs	14	Main probe 1	MainPrb_1
	16				Main probe 2	MainPrb_2	2
	18				Limit probe 1	LimPrb_1	2
20	Limit probe 2				LimPrb_2	2	
22	Pressure on bypass				PressByPass	2	
24	Pressure on main line		Press	2			
26	Bypass temperature		TempByPass	2			
28-32-36-40-44-48-52- 56	Humidity from wireless probe 1 - 8		Inputs_WPrbs.WirelessPrbVal_1 - 8.Hum	2			
30-34-38-42-46-50-54-58	Temperature from wireless probe 1 - 8		Inputs_WPrbs.WirelessPrbVal_1 - 8.Temp	2			
Coils	Remote control		1	Alarms reset	Alarms.AlrmResBySV	1	
		2	Unit on/off from supervisor	OnOff_Status.SVOn	1		
Holding registers	Remote control	1	Unit request from supervisor zone 1	Regulation.SVReq_1	2		
		3	Unit request from supervisor zone 2	Regulation.SVReq_2	2		
Holding registers	Remote control	5	Setpoint zone 1 (humidity)	RegCfg_1.SetP_hum	2		
		7	Setpoint zone 1 (temperature)	RegCfg_1.SetP_temp	2		
		9	Setpoint limit zone 1 (humidity)	RegCfg_1.SetPLim_hum	2		
		11	Setpoint limit zone 1 (temperature)	RegCfg_1.SetPLim_temp	2		
		13	Setpoint zone 2 (humidity)	RegCfg_2.SetP_hum	2		
		15	Setpoint zone 2 (temperature)	RegCfg_2.SetP_temp	2		
		17	Setpoint limit zone 2 (humidity)	RegCfg_2.SetPLim_hum	2		
19	Setpoint limit zone 2 (temperature)	RegCfg_2.SetPLim_temp	2				

Tab. 8.a

8.4 List of BACnet parameters

Type	Section	BACNet	Parameter	Variable	Dir		
Binary values	Unit status	0	Unit on/off	UnitOn	R		
	Alarms	1	Circuit breaker intervention	Al_CircBreaker.Active	R		
		2	High pressure switch intervention	Al_HiPSwitch.Active	R		
		3	High pressure	Al_HiP.Active	R		
		4	Low pressure	Al_LoP.Active	R		
		5	High pressure on bypass	Al_HiPByPassBlk.Active	R		
		6	High pressure on bypass	Al_HiPByPass.Active	R		
		7	High temperature on bypass	Al_HiTByPassBlk.Active	R		
		8	High temperature on bypass	Al_HiTByPass.Active	R		
		9	Low pressure on bypass	Al_LoPByPass.Active	R		
		10	Zone drain valves error	Al_Drain.Active	R		
		11	Expansion offline	Al_ExpOffline.Active	R		
		12	Warning high temperature on bypass	Wr_HiTByPass.Active	R		
		13	Retain memory error	Al_Retain.Active	R		
		14	Retain memory writes error	Al_RetainWrite.Active	R		
		15	Main probe 1 error	Al_MainPrb_1.Active	R		
		16	Limit probe 1 error	Al_LimPrb_1.Active	R		
		17	Main probe 2 error	Al_MainPrb_2.Active	R		
		18	Limit probe 2 error	Al_LimPrb_2.Active	R		
		19	Low pressure trasducer error	Al_PressByPass.Active	R		
		20	Bypass temperature probe error	Al_TempByPass.Active	R		
		21	High pressure transducer error	Al_Press.Active	R		
		22	Missing model	Al_MissModel.Active	R		
		23	Water treatment system alarm	Al_WTS.Active	R		
		24 - 31	Wireless probe offline 1 - 8	Al_WPrb_1 - 8.Active	R		
		32	Main probe 1 from wireless error	Al_WPrbMain_1.Active	R		
		33	Limit probe 1 from wireless error	Al_WPrbLim_1.Active	R		
		34	Main probe 2 from wireless error	Al_WPrbMain_2.Active	R		
		35	Limit probe 2 from wireless error	Al_WPrbLim_2.Active	R		
		36 - 39	Unit 1 - 4 alarm	Al_NetUnit_1 - 4.Active	R		
		40	Change oil	Al_Maint_50.Active	R		
		41	Maintenance	Wr_Maint_1000.Active	R		
		42	Maintenance required	Al_Maint_3000.Active	R		
		Remote control	43	Alarms reset	Alarms.AlrmResBySV	RW	
			44	Unit on/off from supervisor	OnOff_Status.SVOn	RW	
		P.I.V.	Unit status	0	Unit Status	UnitStatus	R
		Analog values	Unit status	0	Request zone 1	ReqMsk_1	R
				1	Request zone 2	ReqMsk_2	R
				2	Production zone 1	Prod_1	R
				3	Production zone 2	Prod_2	R
	4			Water consumption 1	WProd_1	R	
	5		Water consumption 2	WProd_2	R		
	Inputs		6	Main probe 1	MainPrb_1	R	
			7	Main probe 2	MainPrb_2	R	
8			Limit probe 1	LimPrb_1	R		
9			Limit probe 2	LimPrb_2	R		
10			Pressure on bypass	PressByPass	R		
11			Pressure on mail line	Press	R		
12			Bypass temperature	TempByPass	R		
13-15-17-19- 21-23-25-27			Humidity from wireless probe 1 - 8	Inputs_WPrbs.WirelessPrbVal_1 - 8.Hum	R		
14-16-18-20-22-24-26-28			Temperature from wireless probe 1 - 8	Inputs_WPrbs.WirelessPrbVal_1 - 8.Temp	R		
Remote control			29	Unit request from supervisor zone 1	Regulation.SVReq_1	RW	
	30		Unit request from supervisor zone 2	Regulation.SVReq_2	RW		
	31		Setpoint zone 1 (humidity)	RegCfg_1.SetP_hum	RW		
	32		Setpoint zone 1 (temperature)	RegCfg_1.SetP_temp	RW		
	33		Setpoint limit zone 1 (humidity)	RegCfg_1.SetPLim_hum	RW		
	34		Setpoint limit zone 1 (temperature)	RegCfg_1.SetPLim_temp	RW		
	35		Setpoint zone 2 (humidity)	RegCfg_2.SetP_hum	RW		
	36		Setpoint zone 2 (temperature)	RegCfg_2.SetP_temp	RW		
	37		Setpoint limit zone 2 (humidity)	RegCfg_2.SetPLim_hum	RW		
	38		Setpoint limit zone 2 (temperature)	RegCfg_2.SetPLim_temp	RW		

Tab. 8.b

9. WIRELESS PROBES, INSTALLATION AND CONFIGURATION

9.1 Type of installation and wireless probe electrical connections

Wireless probes are available for systems where standard wired probes cannot be used, for example modifications to existing installations. An Access Point (CAREL P/N: WS01AB2M20) is used to connect up to four wireless probes. Recommended Carel wireless probes are the room

(WS01G01M00) or industrial versions (WS01F01M00), both of which measure humidity and temperature. The type of installation is shown in the figure below (referring to four wireless room probes):

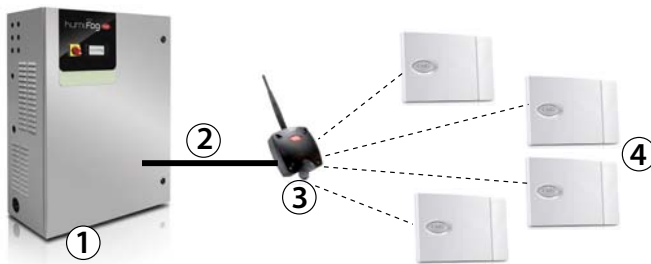

Fig. 9.a

Key:

1. humiFog Direct humidifier;
2. humidifier/access point connection;
3. Access point (WS01AB2M20);
4. Wireless probes for measuring temperature and humidity (WS01G01M00 or WS01F01M00).

humiFog Direct/Access point connection:

To connect the humidifier to the access point, use the Fieldbus connection on terminal M3 (M3.1: Tx/Rx-, M3.2: Tx/Rx+, M3.3: GND):

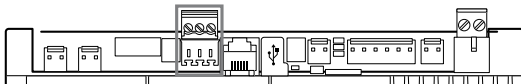

Note: the devices have a range of around a hundred metres in a free space, i.e. without any obstacles. In a closed space, the range varies considerably depending on the type of environment and the surrounding objects (shelves, metal partition walls etc.).

If installing multiple wireless probes, the controller will calculate the weighted average between the various probe readings, depending on the settings made by the user and the defined probe groups.

The table below shows the part numbers and descriptions of the Carel devices that can be used:

P/N	Model	Features	Power supply
WS01F01M00	SI Probe	Temperature/humidity for industrial use	Battery
WS01G01M00	SA probe	Room temperature/humidity	Battery
WS01AB2M20	Access Point	Gateway radio ZigBee™ – RS485 Modbus	12/24 Vac/dc ±10% 100 mA; 50/60 Hz; Use a Class II safety transformer with minimum power rating of 2 VA. A 12 Vac transformer is recommended

Tab. 9.a

9.2 Wireless probe installation

The main steps for installing the wireless devices are:

- power on the access point (12/24 Vac/dc ±10% ϵ m, 100mA) and complete the initialisation procedure, creating the network and selecting the channel;
- after having opened the domain on the access point, complete the binding procedure so as to uniquely identify each probe.

The address to be used by the access point is set using the dipswitches on the device, and is the following:



This assigns the address 2 to the access point, with a baud rate (bit/sec) of 19200 (N82). The addresses of the four serial probes, on the other hand, must be set as shown in the table below:

	Address	Dipswitch							
		1	2	3	4	5	6	7	8
Probe 1	16	0	0	0	0	1	0	0	0
Probe 2	17	1	0	0	0	1	0	0	0
Probe 3	18	0	1	0	0	1	0	0	0
Probe 4	19	1	1	0	0	1	0	0	0

Tab. 9.b

Remember to verify the quality of the wireless signal between the Access Point and each wireless probe.

For a complete description of the installation procedure, see the Carel manual on the corresponding probes and access point.

To configure the probes refer to screens: Dc13, Dc14, Dc15, Dc16 and Dc17.

In particular, screen Dc03 is used to enable the wireless probes connected to the access point, knowing that addresses 16, 17, 18 and 19 are probe 1, probe 2, probe 3 and probe 4 respectively.

- Address: 16
- Address: 17
- Address: 18
- Address: 19

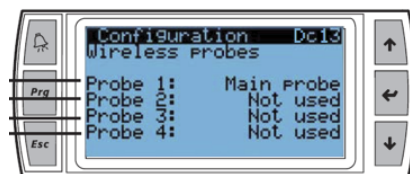

10. ALARM TABLE

The following table shows the alarms that can be displayed, with the corresponding description, causes and possible solutions.

Alarm	Code	Cause	Possible solution	Reset	Alarm relay	Action
Circuit breaker	ABA01	High current due to overload or short-circuit	Check: <ul style="list-style-type: none"> that the circuit breaker is set corresponding to the red dot marked by the manufacturer (+15% rated current motor); there are no short-circuits; that room temperature where the cabinet is installed meets specifications; that the pump shaft is not obstructed; that maintenance has been performed on the unit at regular intervals as described in this manual. 	Manual	Active	Shutdown
High pressure switch	ABA02	Water pressure at the outlet > 90 bars	The alarm corresponds to the opening of the high pressure switch. Check: <ul style="list-style-type: none"> that the pressure switch is correctly connected to terminals J23-1-J23.2; that the pressure switch contact is closed if the pressure is < 90 bars; that there are no blockages in the outlet line; correct calibration of the mechanical bypass valve on the pump. If necessary, replace the high pressure switch.	Manual	Active	Shutdown
High press. on probe HPS	ABA03	Water pressure at the outlet > 80 bars	The alarm corresponds to a pressure reading by probe HPS > 80 bars (screen C01). Check: <ul style="list-style-type: none"> that probe HPS is correctly connected to terminals J3.3-J3.5 and receives power from J3.1; that there are no blockages in the outlet line; correct calibration of the mechanical bypass valve on the pump. If necessary, replace probe HPS.	Manual	Active	Shutdown
Low press. on probe HPS	ABA04	Water pressure at the outlet < 20 bars for more than 30 s with pump running	The alarm corresponds to a pressure reading by probe HPS < 20 bars (screen C01). Check: <ul style="list-style-type: none"> that probe HPS is correctly connected to terminals J3.3-J3.5 and receives power from J3.1; that there are no leaks in the outlet line; correct closing of the drain solenoid valve in zone DR1/DR2 and bypass drain valve BYP (NO valves, 24 Vac to close); that filling is enabled for a duration suitable for the length of the water line. If necessary, replace probe HPS.	Manual	Active	Shutdown
High bypass press.	ABA05	Water pressure in bypass > 8 bars or alarm ALA06 activated more than 3 times in 1 hour	Possible return of pressurised water through the bypass. Check: <ul style="list-style-type: none"> that the bypass drain solenoid valve BYP is able to drain water; correct operation of the mechanical overflow valve (opens at 4 bars). If necessary, replace the bypass drain solenoid valve BYP and/or the overflow valve.	Manual	Active	Shutdown
High bypass temp.	ABA06	Water temperature in bypass > 65°C	Possible extended recirculation of water through the bypass. Check: <ul style="list-style-type: none"> that the humidification capacity set on screen Dc18 is equal to the no. of nozzles x capacity of each nozzle; that the zone can deliver a flow-rate of water ≥ the minimum flow-rate supplied by the pump; that the NTC probe is connected to terminals J5.2-J5.3 	Manual	Active	Shutdown
Low press. on probe LPS	ABA09	No water or feedwater pressure < 0.3 bars	Possible absence of feedwater or low feedwater pressure. Check: <ul style="list-style-type: none"> that there is no alarm on the reverse osmosis system upstream of humiFog Direct that there is an expansion vessel or storage vessel with suitably calibrated pump upstream of humiFog Direct. operation of the fill solenoid valve. 	Manual / automatic	Active	Shutdown (The unit periodically performs up to 30 attempts to restart automatically)
High fill/wash pressure	ABA10	Outlet pressure > 2 bars when filling or washing	Possible blockage of the outlet line. Check: <ul style="list-style-type: none"> correct opening of the NC zone fill solenoid valves (24 Vac when open); correct opening of the NO zone drain solenoid valves (0 Vac when open). 	Manual	Active	Shutdown
Probe LPS disconn.	ABP05	Pressure probe LPS broken or disconnected	Check: <ul style="list-style-type: none"> that probe LPS is correctly connected to terminals J16.1-J16.2 and receives power from J3.1. If necessary, replace the probe.	Manual	Active	Shutdown
Bypass T probe disconn.	ABP06	Bypass temperature probe broken or disconnected	Check: <ul style="list-style-type: none"> that the NTC probe is connected to terminals J5.2-J5.3. If necessary, replace the probe.	Manual	Active	Shutdown

Alarm	Code	Cause	Possible solution	Reset	Alarm relay	Action
Probe HPS disconn.	ABP07	Pressure probe HPS broken or disconnected	Check: • that probe HPS is correctly connected to terminals J3.3-J3.5 and receives power from J3.1. If necessary, replace the probe.	Manual	Active	Shutdown
Model not set	ABC01	Unit model not set	Set the unit model on screen Df05 according to the part number shown on the cabinet door	Automatic	Active	Shutdown
WTS alarm	ABE01	Water treatment system alarm	If input from water treatment system alarm relay is enabled Check the water treatment system upstream of humiFog Direct	Automatic	Active	Shutdown
High bypass press.	ALA06	Water pressure in bypass > 4 bars	Possible return of pressurised water through the bypass. Check: • that the bypass drain solenoid valve BYP is able to drain water; • correct operation of the mechanical overflow valve (opens at 4 bars). If necessary, replace the bypass drain solenoid valve BYP and/or the overflow valve.	Manual	Active	Signal
High bypass temp.	ALA08	Warning WRA12 activated more than 3 times in 1 hour	Possible extended recirculation of water through the bypass. Check: • that the humidification capacity set on screen Dc18 is equal to the no. of nozzles x capacity of each nozzle; • that the zone can deliver a flow-rate of water ≥ the minimum flow-rate supplied by the pump; • that the NTC probe is connected to terminals J5.2-J5.3	Manual	Active	Signal
c.pCOe offline	ALA11	c.pCOe disconnected from c.pHC or wired incorrectly	The c.pCOe expansion that controls zone 2 is offline. Check: • that the unit model is exact (the alarm goes off if the cabinet is single zone but the c.pHC controller is configured for two zones); • that the polarity (+, -, GND) of the wiring between the c.pHC (terminal M3) and c.pCOe (terminal J6 BMS) is correct, as shown on the wiring diagram; • that c.pCOe is powered (24 Vac between G-GO on terminal J1).	Automatic	Active	Signal
T mem. write error	ALM01	Problem on the electronic controller	Reload the default parameters from screen Df06 and reconfigure the unit. If the problem persists, replace the controller.	Manual	Active	Signal
Too many writes to T mem.	ALM02	Problem on the electronic controller	Reload the default parameters from screen Df06 and reconfigure the unit. If the problem persists, replace the controller.	Manual	Active	Signal
Main probe 1 disconn.	ALP01	Main probe in zone 1 broken or disconnected	Check the connection of the main probe in in zone 1 to terminals M2.1-M2.2-M2.3 on the c.pHC	Manual	Active	Signal
Lim. probe 1 disconn.	ALP02	Limit probe in zone 1 broken or disconnected	Check the connection of the limit probe in in zone 1 to terminals M2.4-M2.5-M2.3 on the c.pHC	Manual	Active	Signal
Main probe 2 disconn.	ALP03	Main probe in zone 2 broken or disconnected	Check the connection of the main probe in zone 2 to terminals J2.U1-J2.GND-J9.+Vdc of c.pCOe	Manual	Active	Signal
Lim. probe 2 disconn.	ALP04	Limit probe in zone 2 broken or disconnected	Check the connection of the limit probe in zone 2 to terminals J2.U2-J2.GND-J9.+Vdc of c.pCOe	Manual	Active	Signal
Wireless p. 1 offline	ALP08	No communication with probe 1	Check: • probe/access point binding • battery charge • probe signal level	Automatic	Active	Signal
Wireless p. 2 offline	ALP09	No communication with probe 2	Check: • probe/access point binding • battery charge • probe signal level	Automatic	Active	Signal
Wireless p. 3 offline	ALP10	No communication with probe 3	Check: • probe/access point binding • battery charge • probe signal level	Automatic	Active	Signal
Wireless p. 4 offline	ALP11	No communication with probe 4	Check: • probe/access point binding • battery charge • probe signal level	Automatic	Active	Signal
Wireless p. 5 offline	ALP12	No communication with probe 5	Check: • probe/access point binding • battery charge • probe signal level	Automatic	Active	Signal
Wireless p. 6 offline	ALP13	No communication with probe 6	Check: • probe/access point binding • battery charge • probe signal level	Automatic	Active	Signal

Alarm	Code	Cause	Possible solution	Reset	Alarm relay	Action
Wireless p. 7 offline	ALP14	No communication with probe 7	Check: • probe/access point binding • battery charge • probe signal level	Automatic	Active	Signal
Wireless p. 8 offline	ALP15	No communication with probe 8	Check: • probe/access point binding • battery charge • probe signal level	Automatic	Active	Signal
Main probe 1 offline	ALP16	No communication with all the wireless probes - main control in zone 1	Check: • probe connections • probe/access point binding • access point power supply	Automatic	Active	Signal
Limit probe 1 offline	ALP17	No communication with all the wireless probes - limit control in zone 1	Check: • probe connections • probe/access point binding • access point power supply	Automatic	Active	
Main probe 2 offline	ALP18	No communication with all the wireless probes - main control in zone 2	Check: • probe connections • probe/access point binding • access point power supply	Automatic	Active	Signal
Limit probe 2 offline	ALP19	No communication with all the wireless probes - limit control in zone 2	Check: • probe connections • probe/access point binding • access point power supply	Automatic	Active	Signal
Unit 1 alarm	ALN01	Alarm on unit no. 1 in network	Only if network function is active Carry out the checks based on the alarm displayed on the unit in question	Automatic	Active	Signal
Unit 2 alarm	ALN02	Alarm on unit no. 2 in network	Only if network function is active Carry out the checks based on the alarm displayed on the unit in question	Automatic	Active	Signal
Unit 3 alarm	ALN03	Alarm on unit no. 3 in network	Only if network function is active Carry out the checks based on the alarm displayed on the unit in question	Automatic	Active	Signal
Unit 4 alarm	ALN04	Alarm on unit no. 4 in network	Only if network function is active Carry out the checks based on the alarm displayed on the unit in question	Automatic	Active	Signal
High bypass temp.	WRA12	Water temperature in bypass > 50°C	Possible extended recirculation of water through the bypass. Check: • that the humidification capacity set on screen Dc18 is equal to the no. of nozzles x capacity of each nozzle; • that the zone can deliver a flow-rate of water ≥ the minimum flow-rate supplied by the pump; • that the NTC probe is connected to terminals J5.2-J5.3	-		Warning
Low pressure	-	Pressure measured by probe HPS < 60 bars with pump running	Possible small water leaks at the outlet, check tightness of the hose fittings and make sure there are no leaks from the drain solenoid valves DR1 and DR2. Check that the pump is able to deliver the flow-rate required to satisfy the load provided by the nozzles.	-	Inactive	Warning

Tab. 10.a

11. MAINTENANCE

11.1 Routine maintenance

Routine maintenance is recommended every three months, and mainly involves visual inspection of correct operation of the main components.

The following is a list of recommended operations:

- **Check water inlet filter.**

It is recommended to change the filter cartridge once every 6-12 months. To change the cartridge, switch the unit off and close the feedwater line. Empty the filter using the small tap at the bottom. Unscrew the white holder from the nut at the top using the tool provided. Remove the filter cartridge inside and fit a new one (P/N ECKFILT050). Tighten the holder, ensuring that the O-ring is still in good condition to ensure tightness. Close the tap under the holder and open the feedwater line.

- **Check pump oil level.**

To check the level visually, use a mirror that allows a view of side of the pump facing to the cabinet wall. There is a small mark behind a circular transparent Plexiglas cover. The oil level is correct when around the middle of the circle. If the level is lower than the minimum shown in the figure, top up with oil to the correct level (oil P/N 5024646AXX). Generally the oil level should remain constant and periodical top ups should not be needed. If oil leaks are found, contact CAREL.

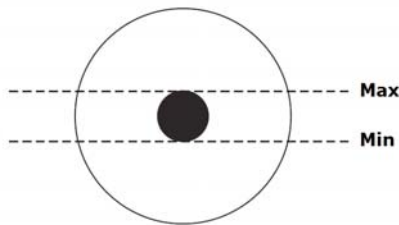

Fig. 11.a

- **Check the nozzles: make sure the spray cone from the nozzles is regular.**

Even when using demineralised water, some particle may at times build-up on the nozzle opening, making the spray cone less uniform and affecting absorption efficiency. If this happens, remove the nozzle (unscrew using a 10 mm spanner) and clean it (immersing in acetic acid to remove scale) or replace it (P/N UAKMTP%000). Before fitting the nozzle again, remove the residual Teflon from the thread and apply sealant again to ensure water-tightness.

- **Check the fans**

Make sure that all of the fans on the blower units are working. In the event of malfunctions, check the power supply wiring. If the wiring is OK, replace the fan.

- **Check** that there are no water leaks inside cabinet and on the distribution line and fittings.

11.2 Special maintenance

Special maintenance involves all those operations that are performed on a one-off basis in the event of malfunctions or breakages of certain components.

The following components are those susceptible to breakage:

- solenoid valves
- pressure reducer
- pressure switches
- pump motor
- pump
- electronic controller
- fuses
- nozzles
- nozzle manifold
- fans on the blower units

To replace these contact specialist and authorised personnel. For the spare part numbers, see table "9.5 Spare parts".

11.3 Pump maintenance

The pump is the most complex mechanical device inside the cabinet, as well as the heart of the high pressure system. It therefore requires specific regular maintenance, comprising at least three operations (described below).

11.3.1 Oil change

Important: after the first 50 hours of operation, the oil in the pump needs to be changed (P/N 5024646AXX). Failure to change the oil after the first 50 hours may cause damage to the pump and reduce its working life. The first oil supplied, in fact, will accumulate debris due to transport and commissioning, and a longer operating time cannot be guaranteed.

In normal operating conditions, except for the first oil change oil after 50 hours, it is recommended the change the oil every 3000 operating hours. Expiry of the 3000 operating hours is signalled by the electronic controller via the "3000 hour maintenance" alarm on the display.

To change the oil, follow the sequence described below (with the unit off and the water line closed):

1. Remove the yellow cap on the top of the pump and unscrew the oil drain plug attraction the bottom (steel hexagonal plug).
2. Empty the oil into a suitable container. Close the plug.
3. Dispose of the oil in accordance with local standards.
4. Fill the pump body with SAE 15W40 mineral oil, up to the level suggested by the circular marker on the side of the pump (the required oil content is around 350 ml).
5. Finally, close the yellow cap on the top of the pump.

11.3.2 Gasket and valve replacement

The gaskets and valves require replacement every each 3000 hours, as signalled on the display by the "3000 hour maintenance" alarm. Nonetheless, in specific conditions of stress replacement may be needed earlier.

Carel recommends to check the pump operation every 1000 operating hours (signalled by a warning). If the pump makes noise, or is not able to reach the required operating pressure (70 bars), the gaskets and valves may need to be replaced sooner.

Valves and gaskets are consumables, and wear does not reflect a product malfunction.

To replace the gaskets, proceed as follows:

1. Disconnect the wiring from the high pressure switch, solenoid valve BYP and the NTC probe.
2. Disconnect the pump outlet hose (at the top right).
3. Unscrew the eight hex screws that hold the pump head to the guard.
4. Remove the gaskets and replace them with new ones (P/N UAKVGO1501).
5. Tighten the eight hex screws so as to secure the pump head to the guard.
6. Connect the outlet hose to the pump.
7. Reconnect the pressure switch, solenoid valve and NTC probe

To replace the valves, proceed as follows:

1. Unscrew the three hexagonal caps on the front of the brass pump head.
2. Unscrew the three hexagonal caps on the top of the brass pump head.
3. Replace the six valves with new ones (P/N UAKVGO1501).
4. Tighten the six caps removed previously.

11.4 50 hour oil change warning

The first "oil change required" maintenance warning is shown after 50 operating hours: this indicates that the oil needs to be changed immediately. This warning is typically displayed a few days after the systems is first started. Therefore when starting the system, make sure a spare can of oil is available for the first oil change, in accordance with the procedure described in paragraph "9.3.1 Oil change".

The warning can be easily reset by pressing the "Alarm" button on the user interface (button at the top left).

For practical reasons, the warning can also be reset after 40 operating hours, entering the "control menu > screen Da10". The warning cannot be reset before 40 operating hours.

11.5 Maintenance warning and alarm, reset hour counter

After 1000 hours of operation, humiFog Direct shows a "1000 hour maintenance" warning, however without shutting down the unit. This warning reminds the user to check correct system operation. If the pump manages to reach the rated operating pressure of 70 bars, no action needs to be taken.

The warning can be easily reset by pressing the "Alarm" button on the user interface (button at the top left).

The same warning is shown after 2000 operating hours.

After 3000 operating hours, on the other hand, humiFog Direct shows a "3000 hour maintenance" alarm and the unit shuts down. In this case is necessary intervene on the unit, changing the oil and replacing the gaskets and the valves of the pump (as described in paragraph 9.3.1 and 9.3.2).

Will be necessary subsequently reset the alarm in the menu "Control > screen Da09" and press subsequently the "Alarm" button of the display.

If for some reason the gaskets and valves need to be replaced before 3000 operating hours, the hour counter needs to be reset on screen Da09. It is recommended, whenever replacing the gaskets and valves, to also change the oil before resetting the hour counter.

11.6 Blower spare parts

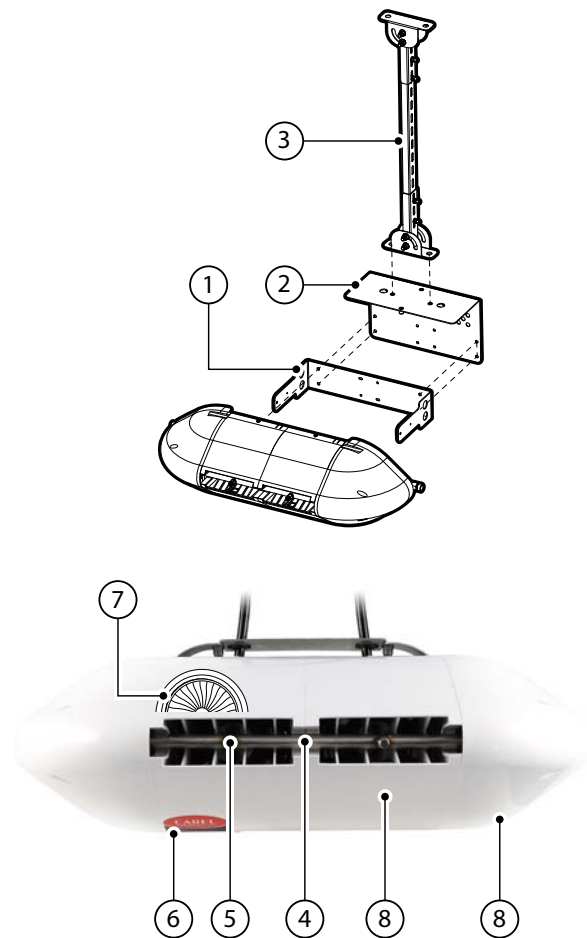

Fig. 11.b

No.	Description	Code
1	Wall mounting bracket, single blower, 2 nozzles (DLA02*F*00)	UAKHW20000
	Wall mounting bracket, single blower, 4 nozzles (DLA04*F*00)	UAKHW40000
2	Ceiling mounting adapter, single blower, 2 nozzles (DLA02*F*00)	UAKHC20000
	Ceiling mounting adapter, single blower, 4 nozzles (DLA04*F*00)	UAKHC40000
3	Ceiling mounting bracket, L = 0.5 m	UAKVC00500
	Ceiling mounting bracket, L = 1.0 m	UAKVC01000
4	2 nozzle water manifold, single blower	Contact CAREL
	4 nozzle water manifold, single blower	Contact CAREL
	4 nozzle water manifold, double blower	Contact CAREL
	8 nozzle water manifold, double blower	Contact CAREL
5	Individual nozzle, flow-rate 1.45 l/h @ 70 bars	UAKMTP0000
	Individual nozzle, flow-rate 2.8 l/h @ 70 bars	UAKMTP1000
	Individual nozzle, flow-rate 4.0 l/h @ 70 bars	UAKMTP2000
6	Power LED	Contact CAREL
7	CE fan – 230 V 50 Hz	Contact CAREL
	UL fan – 120 V 60 Hz	Contact CAREL
8	Plastic cover	Contact CAREL

Tab. 11.b

11.7 Cabinet spare parts

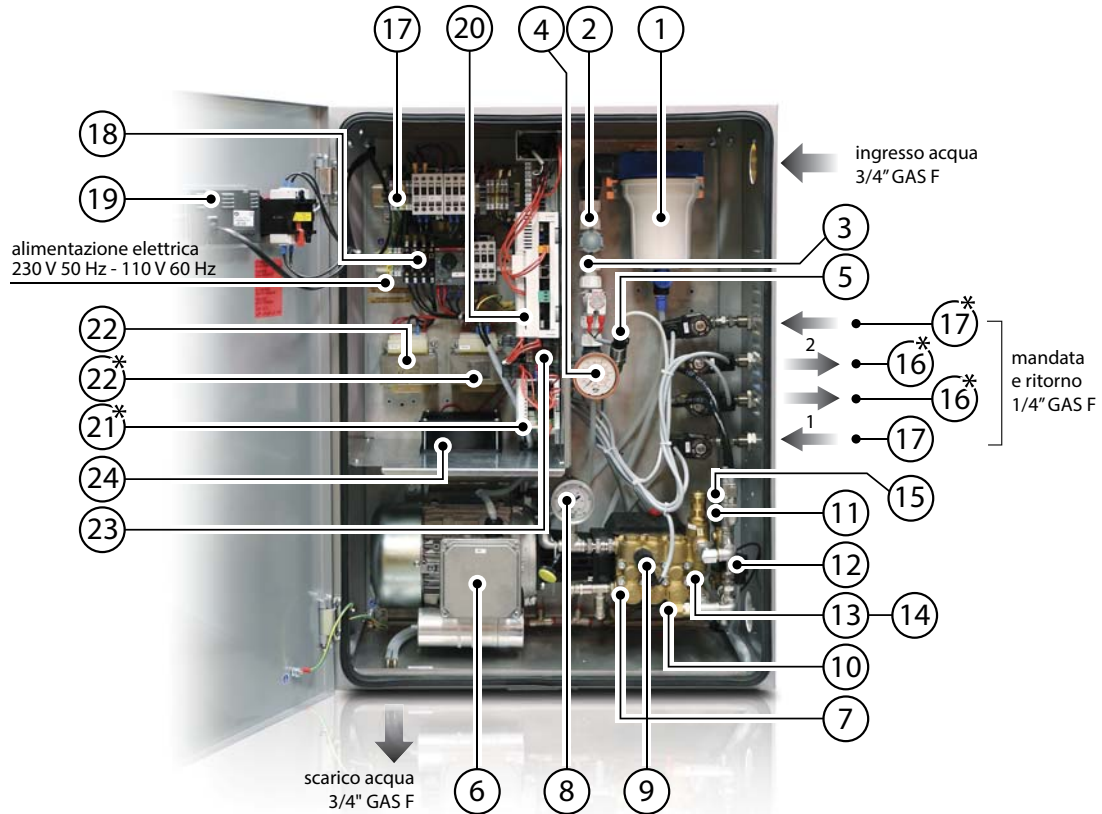

Fig. 11.c

No.	Description	Code
1	Inlet filter holder (casing only), 5", with drain tap	ECKVESS050
	Inlet filter cartridge, 5", 60 µm pore size	ECKFILT050
2	Pressure reducer	UAKRID0010
3	N.C. fill solenoid valve	ECKFSV0000
4	Low pressure gauge, scale 0-12 bars, rear fitting 1/4" GAS	MCKMA12000
5	LPS pressure transducer on low pressure inlet line	UAKSPLPV00
6	CE motor, 4 poles, 180 W power (for UA040DD%00)	UAKM018F51
	CE motor, 4 poles, 370 W power (for UA080DD%00)	UAKM037F51
	UL motor, 4 poles, 180 W power (for UA050DU%00)	UAKM018F52
	UL motor, 4 poles, 370 W power (for UA090DU%00)	UAKM037F52
7	40-50 l/h pump kit, brass	UAKP040M00
	80-90 l/h pump kit, brass	UAKP080M00
	Valve and gasket kit for pump (for all humiFog Direct models)	UAKVGO1501
	Replacement oil	5024646AXX
8	High pressure gauge, scale 0-100 bars, radial fitting 1/4" GAS	UAKMWHP001
9	Pump high pressure switch (calibration 90 bars)	UAKPSHP000
10	Temperature-controlled safety valve	1309549AXX

No.	Description	Code
11	HPS pressure transducer on high pressure outlet line	UAKSPHPA00
12	NTC probe for measuring bypass water temperature	NTC030WH01
13	Mechanical overflow valve, brass	Contact CAREL
14	Pump drain solenoid valve, 1/8" GAS fitting	UAKDRC00003
15	Bypass solenoid valve	UAKFL000000
16	N.C. fill solenoid valve	UAKFL000000
17	N.O. return solenoid valve	UAKDR000000
18	Fuse kit (see paragraph 2.3.1)	UAKFUSEDRO
19	pGD display	PGD1000FW0
20	c.pHC programmed for humiFog Direct	UAKCPHCD00
21	c.pCOe for humiFog Direct (two-zone cabinet only, plug & play)	P+E0000000000
22	Transformer for CE cabinet (1 for single zone, 2 for two-zone)	URKTR20000
	Transformer for UL cabinet (1 for single zone, 2 for two-zone)	Contact CAREL
23	SSR relay, Vdc (1 for single zone, 4 for two-zone)	UAKRES2411
	SSR relay, Vac (one for all models)	UAKRES2401
24	Pump motor cooling fan	1312545AXX

Tab. 11.c

12. APPENDIX

12.1 Single-zone cabinet wiring diagram

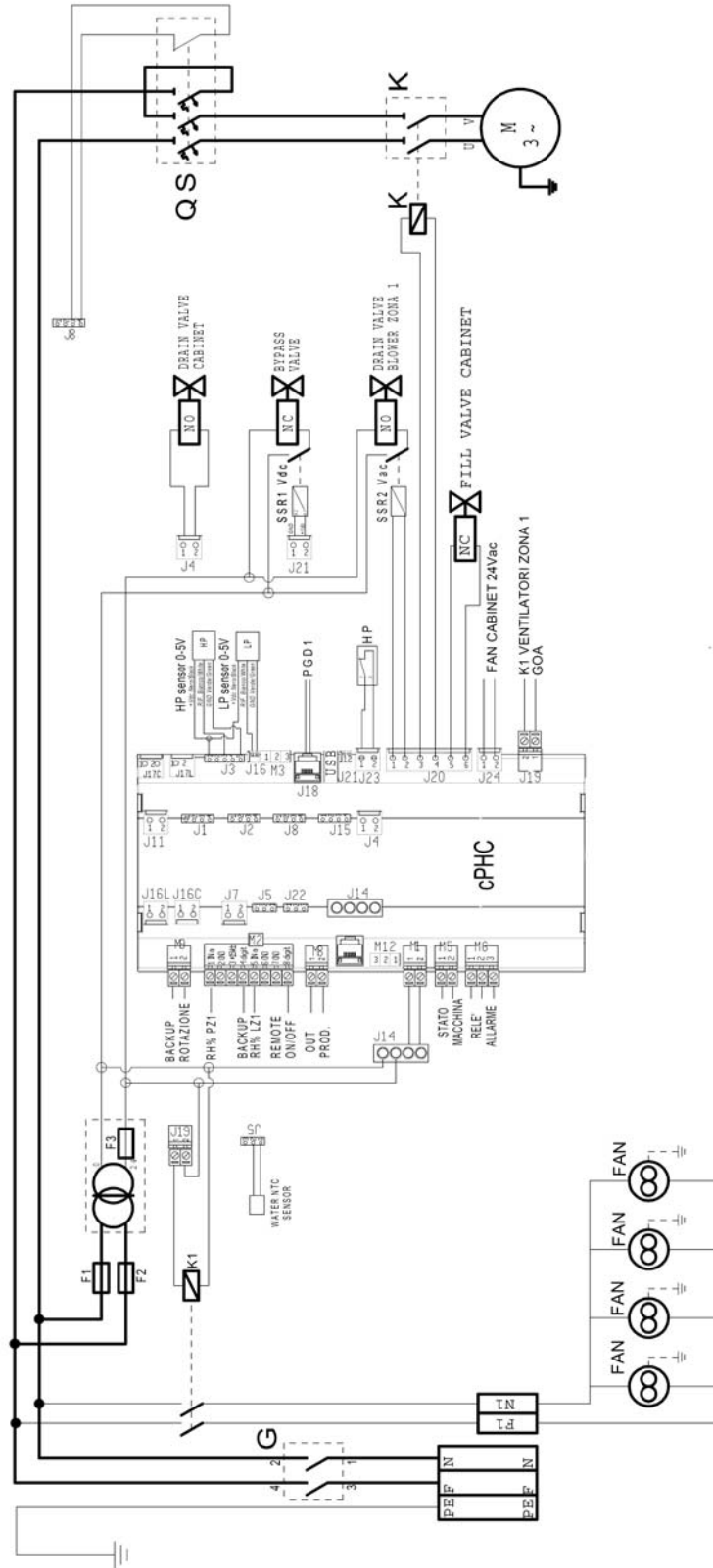

Fig. 12.a

12.2 Two-zone cabinet wiring diagram

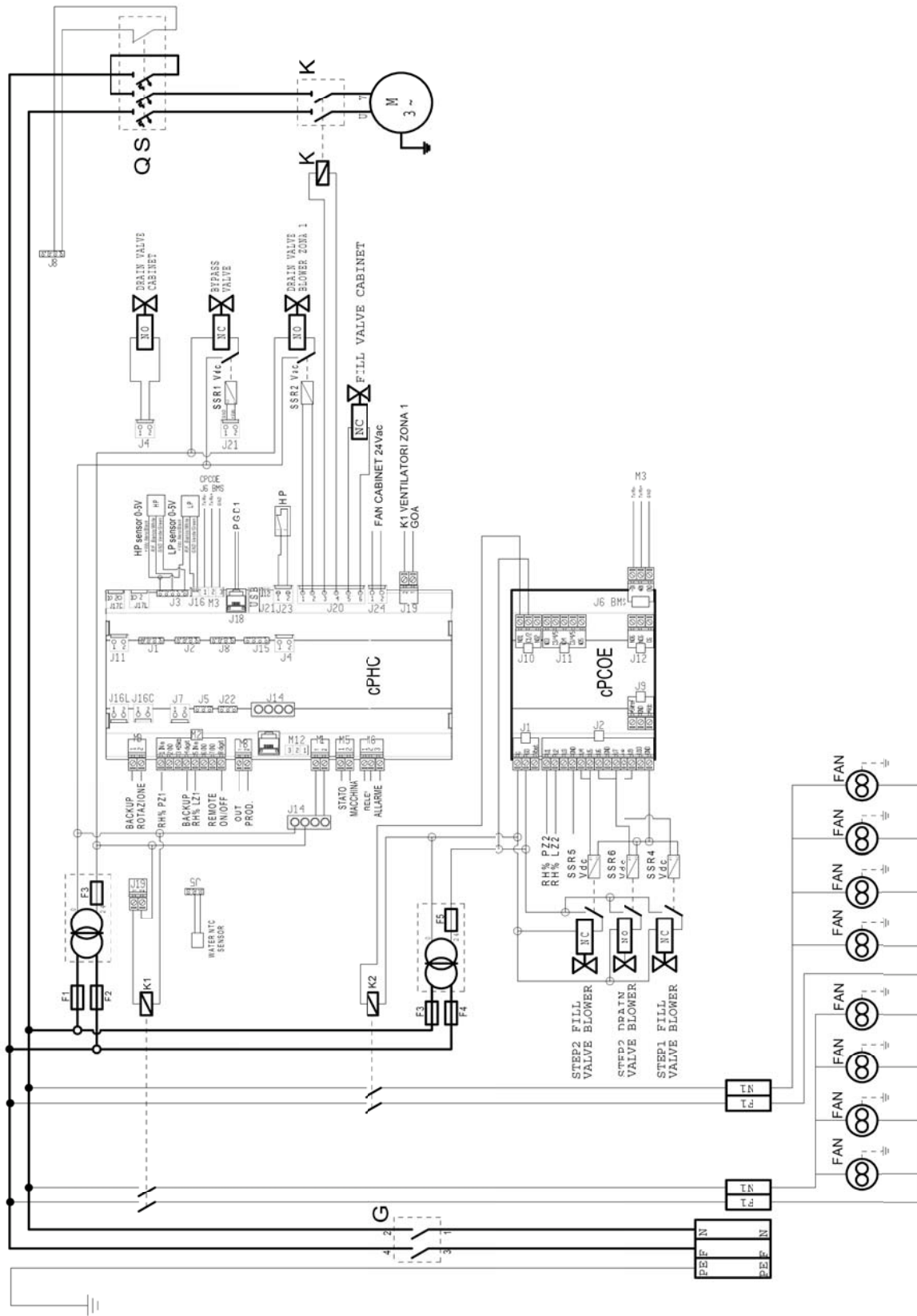

Fig. 12.b

12.3 Datasheets

12.3.1 CE version cabinet datasheet

PHYSICAL SPECIFICATIONS	UA040DD*00	UA080DD*00
Dimensions	630 x 800 x 300 mm	630 x 800 x 300 mm
Weight	60 kg (single-zone)	64 kg (single-zone)
	64 kg (two zones)	68 kg (two zones)
Packaged dimensions	720 x 1020 x 460 mm	720 x 1020 x 460 mm
Packaged weight	64 kg (single-zone)	68 kg (single-zone)
	68 kg (two zones)	72 kg (two zones)
Delivery and storage temperature and humidity	-10/50°C 0-90% rH	-10/50°C 0-90% rH
Operating temperature and humidity	2/40°C 5-95% rH	2/40°C 5-95% rH
IP rating	IP20	IP20
Conformity	EN60204-1 2006; EN61000-6-2 2006; EN61000-6-4 2007	EN60204-1 2006; EN61000-6-2 2006; EN61000-6-4 2007

Tab. 12.a

ELECTRICAL SPECIFICATIONS	UA040DD*00	UA080DD*00
Power supply	230 V 50 Hz single-phase	230 V 50 Hz single-phase
Cabinet power cable	AWG 14	AWG 14
Power (cabinet only, without blowers)	0.28 kW (single-zone)	0.47 kW (single-zone)
	0.38 kW (two zones)	0.57 kW (two zones)
Current (cabinet only, without blowers)	2.5 A (single-zone)	3.5 A (single-zone)
	3.0 A (two zones)	4.0 A (two zones)
Maximum power (cabinet with blowers)	0.81 kW (single-zone)	1.0 kW (single-zone)
	0.91 kW (two zones)	1.1 kW (two zones)
Maximum current (cabinet with blowers)	4.8 A (single-zone)	7.1 A (single-zone)
	5.0 A (two zones)	7.6 A (two zones)
FLA (Full Load Amperes)	0.25HP/180W 2 A	0.5HP/370W 3 A
SCCR (Short Circuit Current Rating)	5 kA	5 kA
Minimum cable size required for blower power supply	AWG 14	AWG 14

Tab. 12.b

WATER CIRCUIT SPECIFICATIONS	UA040DD*00	UA080DD*00
Required feedwater quality	demineralised	demineralised
Required feedwater conductivity	5-80 µS/cm	5-80 µS/cm
Required feedwater pressure	3-8 bars	3-8 bars
Water inlet connection	3/4" GAS F	3/4" GAS F
Water drain connection	1/2" GAS F	1/2" GAS F
Water outlet connection	1/4" GAS F	1/4" GAS F
Water outlet pressure	70 bars	70 bars
Maximum capacity	40 l/h	80 l/h

Tab. 12.c

FUNCTIONAL SPECIFICATIONS	UA040DD*00	UA080DD*00
Number of probes allowed (temperature and/or humidity)	1 (single-zone) + limit	1 (single-zone) + limit
	2 (two-zone) + limit	2 (two-zone) + limit
External signal or type of probes	0-10 V, 4-20 mA, 0-1 V, 2-10 V, 0-20 mA, NTC probe	0-10 V, 4-20 mA, 0-1 V, 2-10 V, 0-20 mA, NTC probe
Multi-probe	available	available
Web server	available	available
Serial communication (via Ethernet and/or via RS485)	Modbus, BACnet	Modbus, BACnet

Tab. 12.d

12.3.2 UL version cabinet datasheet

PHYSICAL SPECIFICATIONS	UA050DU*00	UA090DU*00
Dimensions	630 x 800 x 300 mm	630 x 800 x 300 mm
Weight	60 kg (single-zone)	64 kg (single-zone)
	64 kg (two zones)	68 kg (two zones)
Packaged dimensions	720 x 1020 x 460 mm	720 x 1020 x 460 mm
Packaged weight	64 kg (single-zone)	68 kg (single-zone)
	68 kg (two zones)	72 kg (two zones)
Delivery and storage temperature and humidity	-10/50°C 0-90% rH	-10/50°C 0-90% rH
Operating temperature and humidity	2/40°C 5-95% rH	2/40°C 5-95% rH
IP rating	IP20	IP20
Conformity	UL998	UL998

Tab. 12.e

ELECTRICAL SPECIFICATIONS	UA050DU*00	UA090DU*00
Power supply	120 Vac 60 Hz single-phase	120 Vac 60 Hz single-phase
Cabinet power cable	AWG 14	AWG 12
Power (cabinet only, without blowers)	0.28 kW (single-zone) 0.38 kW (two zones)	0.47 kW (single-zone) 0.57 kW (two zones)
Current (cabinet only, without blowers)	5.0 A (single-zone) 5.8 A (two zones)	8.0 A (single-zone) 8.8 A (two zones)
Maximum power (cabinet with blowers)	0.74 kW (single-zone) 0.84 kW (two zones)	0.93 kW (single-zone) 1.03 kW (two zones)
Maximum current (cabinet with blowers)	10.3 A (single-zone) 11.0 A (two zones)	13.3 A (single-zone) 14.0 A (two zones)
FLA (Full Load Amperes)	0.25HP/180W 4.2 A	0.5HP/370W 7.1 A
SCCR (Short Circuit Current Rating)	5 kA	5 kA
Minimum cable size required for blower power supply	AWG 14	AWG 12

Tab. 12.f

WATER CIRCUIT SPECIFICATIONS	UA050DU*00	UA090DU*00
Required feedwater quality	demineralised	demineralised
Required feedwater conductivity	5-80 µS/cm	5-80 µS/cm
Required feedwater pressure	3-8 bars	3-8 bars
Water inlet connection	3/4" GAS F	3/4" GAS F
Water drain connection	1/2" GAS F	1/2" GAS F
Water outlet connection	1/4" GAS F	1/4" GAS F
Water outlet pressure	70 bars	70 bars
Maximum capacity	50 l/h	90 l/h

Tab. 12.g

FUNCTIONAL SPECIFICATIONS	UA050DU*00	UA090DU*00
Number of probes allowed (temperature and/or humidity)	1 (single-zone) + limit 2 (two-zone) + limit	1 (single-zone) + limit 2 (two-zone) + limit
External signal or type of probes	0-10 V, 4-20 mA, 0-1 V, 2-10 V, 0-20 mA, NTC probe	0-10 V, 4-20 mA, 0-1 V, 2-10 V, 0-20 mA, NTC probe
Multi-probe	available	available
Webserver	available	available
Serial communication (via Ethernet and/or via RS485)	Modbus, BACnet	Modbus, BACnet

Tab. 12.h

12.3.3 CE version blower datasheet

Single blower units (for wall-mounting)	DLA02DF*00	DLA04DF*00
Dimensions	640 x 200 x 180 mm	940 x 200 x 180 mm
Weight	4.5 kg	5.6 kg
Packaged dimensions	755 x 235 x 295 mm	1050 x 235 x 295 mm
Packaged weight	5.7 kg	7.4 kg
Delivery and storage temperature	-10/50°C 0-90%	-10/50°C 0-90%
Operating temperature	2/40°C 5-95%	2/40°C 5-95%
Ingress protection (IP)	IP10	IP10
Conformity	CE	CE
Water fitting	M16x1.5 Male	M16x1.5 Male
Water outlet	M16x1.5 Male	M16x1.5 Male
Number of nozzles	2	4
Flow-rate (depending on the type of nozzles)	3.0 l/h - 5.6 l/h - 8.0 l/h	6.0 l/h - 11.2 l/h - 16.0 l/h
Power supply	230 Vac 50 Hz	230 Vac 50 Hz
Fan total air flow-rate	300 m3/h	600 m3/h
Blower connection cable	AWG 14	AWG 14
Maximum number of blower units (connected to one cabinet)	12	6

Tab. 12.i

Double blower units (for mounting in centre of corridor) CE version	DLA04DB*00	DLA08DB*00
Dimensions	640 x 200 x 400 mm	940 x 200 x 400 mm
Weight	9.2 kg	15.5 kg
Packaged dimensions	755 x 470 x 295 mm	1050 x 470 x 295 mm
Packaged weight	11.4 kg	18.0 kg
Delivery and storage temperature	-10/50°C 0-90%	-10/50°C 0-90%
Operating temperature	2/40°C 5-95%	2/40°C 5-95%
Ingress protection (IP)	IP10	IP10
Conformity	CE	CE
Water fitting	M16x1.5 Female	M16x1.5 Female
Water outlet	M16x1.5 Female	M16x1.5 Female
Number of nozzles	4	8
Flow-rate (depending on the type of nozzles)	6.0 l/h - 11.2 l/h - 16.0 l/h	12.0 l/h - 22.4 l/h - 32 l/h
Power supply	230 Vac 50 Hz	230 Vac 50 Hz
Fan total air flow-rate	600 m3/h	1,200 m3/h
Blower connection cable	AWG 14	AWG 14
Maximum number of blower units (connected to one cabinet)	6	3

Tab. 12.j

12.3.4 UL version blower datasheet

Single blower units (for wall-mounting) UL version	DLA02UF*00	DLA04UF*00
Dimensions	640 x 200 x 180 mm	940 x 200 x 180 mm
Weight	4.5 kg	5.6 kg
Packaged dimensions	755 x 235 x 295 mm	1050 x 235 x 295 mm
Packaged weight	5.7 kg	7.4 kg
Delivery and storage temperature	-10/50°C 0-90%	-10/50°C 0-90%
Operating temperature	2/40°C 5-95%	2/40°C 5-95%
Ingress protection (IP)	IP10	IP10
Conformity	UL	UL
Water fitting	M16x1.5 Male	M16x1.5 Male
Water outlet	M16x1.5 Male	M16x1.5 Male
Number of nozzles	2	4
Flow-rate (depending on the type of nozzles)	3.0 l/h - 5.6 l/h - 8.0 l/h	6.0 l/h - 11.2 l/h - 16.0 l/h
Power supply	120 Vac 60 Hz	120 Vac 60 Hz
Fan total air flow-rate	360 mc/h	720 mc/h
Blower connection cable	AWG 14 with UA050%	AWG 14 with UA050%
	AWG 12 with UA090%	AWG 12 with UA090%
Maximum number of blower units (connected to one cabinet)	12	6

Tab. 12.k

Double blower units (for mounting in centre of corridor) UL version	DLA04UB*00	DLA08UB*00
Dimensions	640 x 200 x 400 mm	940 x 200 x 400 mm
Weight	9.2 kg	15.5 kg
Packaged dimensions	755 x 470 x 295 mm	1050 x 470 x 295 mm
Packaged weight	11.4 kg	18.0 kg
Delivery and storage temperature	-10/50°C 0-90%	-10/50°C 0-90%
Operating temperature	2/40°C 5-95%	2/40°C 5-95%
Ingress protection (IP)	IP10	IP10
Conformity	UL	UL
Water fitting	M16x1.5 Female	M16x1.5 Female
Water outlet	M16x1.5 Female	M16x1.5 Female
Number of nozzles	4	8
Flow-rate (depending on the type of nozzles)	6.0 l/h - 11.2 l/h - 16.0 l/h	12.0 l/h - 22.4 l/h - 32 l/h
Power supply	120 Vac 60 Hz	120 Vac 60 Hz
Fan total air flow-rate	720 m3/h	1,440 m3/h
Blower connection cable	AWG 14 with UA050%	AWG 14 with UA050%
	AWG 12 with UA090%	AWG 12 with UA090%
Maximum number of blower units (connected to one cabinet)	6	3

Tab. 12.l

CAREL

CAREL INDUSTRIES - Headquarters
Via dell'Industria, 11 - 35020 Brugine - Padova (Italy)
Tel. (+39) 049.9716611 - Fax (+39) 049.9716600
e-mail: carel@carel.com - www.carel.com

Agenzia / Agency: