

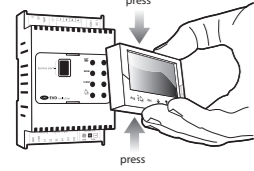

**LEGGI E CONSERVA QUESTE ISTRUZIONI**  
**READ AND SAVE THESE INSTRUCTIONS**



### Montaggio scheda display Display board mounting



### Compatibilità refrigeranti Refrigerant compatibility

R22; R134a; R404A; R407C; R410A; R507A; R290; R600; R600a; R717; R744; R728; R1270; R417A; R422D; R413A; R422A; R423A; R407A; R427A; R245Fa; R407F; R32; HTR01; HTR02

### Tabella codici / Table of product codes

EVD evolution		display (accessorio/accessory)	
code	description	code	description
EVD0000E00	EVD Evolution universal (tLAN)	EVDIS00CNO	Display (Chinese)
EVD0000E01	EVD Evolution universal (tLAN), 10 pz* (pcs)	EVDIS00CZO	Display (Czech)
EVD0000E10	EVD Evolution universal (pLAN)	EVDIS00DEO	Display (German)
EVD0000E11	EVD Evolution universal (pLAN), 10 pz* (pcs)	EVDIS00ENO	Display (English)
EVD0000E20	EVD Evolution universal (RS485/Modbus*)	EVDIS00ESO	Display (Spanish)
EVD0000E21	EVD Evolution universal (RS485/Modbus*), 10 pz* (pcs)	EVDIS00FRO	Display (French)
EVD0000E30	EVD Evolution for CAREL valves (tLAN)	EVDIS00ITO	Display (Italian)
EVD0000E31	EVD Evolution for CAREL valves (tLAN), 10 pz* (pcs)	EVDIS00JPO	Display (Japanese)
EVD0000E40	EVD Evolution for CAREL valves (pLAN)	EVDIS00PLO	Display (Polish)
EVD0000E41	EVD Evolution for CAREL valves (pLAN), 10 pz* (pcs)	EVDIS00PTO	Display (Portuguese)
EVD0000E50	EVD Evolution for CAREL valves (RS485/Modbus*)	EVDIS00RUO	Display (Russian)
EVD0000E51	EVD Evolution for CAREL valves (RS485/Modbus*), 10 pz* (pcs)	EVDIS00SEO	Display (Swedish)
EVD0002E10	EVD Evolution universal optoisolated (pLAN)		
EVD0002E20	EVD Evolution universal optoisolated (RS485/Modbus*)		

(\* La confezione con imballo multiplo non è fornita di connettori / The multiple packages are not supplied with connectors)

### Tabella compatibilità valvole / Table of valve compatibility

Model	Model
CAREL E*v****	
ALCO EX4; EX5; EX6; EX7; EX8 330 Hz (consigliato da CAREL/supported by CAREL); EX8 500 Hz (da specifiche ALCO/from ALCO specifications)	
SPORLAN SEI 0.5-11; SER 1.5-20; SEI 30; SEI 50; SEH 100; SEH 175	
Danfoss ETS 12.5-25B; ETS 50B; ETS 100B; ETS 250; ETS 400; CCM 10-20-30; CCM 40	
CAREL Due EXV CAREL collegate insieme / Two CAREL EXv connected together	
SPORLAN SER(I) G, J, K	

**ITA** Per ulteriori informazioni, consultare la "Guida al sistema EEV" (code +030220810) e il manuale d'uso (codice +03000005IT) disponibili sul sito [www.carel.com](http://www.carel.com), alla sezione "Documentazione".

Tabella LED EVD		
LED	accesso	spento
net	collegamento presente	collegamento assente
open	apertura valvola	errore di comunicazione
close	chiusura valvola	prima configurazione
alarm	allarme attivo	prima configurazione
driver	driver alimentato	driver non alimentato
		alimentazione errata

Nota: se i LED open e close lampeggiano contemporaneamente, deve essere eseguita la procedura di prima messa in servizio.

### Tastiera scheda display

- Prig** presenta direttamente la maschera per l'immissione della password per l'accesso al modo di programmazione
- Esc** esce dalla modalità di programmazione (assistenza, costruttore) e visualizzazione; dopo la modifica di un parametro esce senza salvare la modifica.
- Help** se in stato di allarme permette di visualizzare la coda allarmi; nel livello "costruttore", durante lo scorrimento dei parametri, fa apparire le maschere di spiegazioni relative /help.

**ENG** For further information, see the "EEV system guide" (code +030220810) and the user manual (code +03000005EN) available at [www.carel.com](http://www.carel.com), under the "Literature" section.

Table of EVD LEDs		
LED	on	off
net	connection made	no connection
open	valve opening	communication error
close	valve closing	first configuration
alarm	alarm active	first configuration
driver	driver powered	driver not powered
		wrong power supply

Note: if open and close LEDs blink at the same time, the commissioning procedure has to be executed.

### Display keypad

- Prig** goes directly to the screen for entering the password to access programming mode
- Esc** exits programming mode (service, manufacturer) and display;
- Help** after setting a parameter, exits without saving the change.
- Help** in alarm mode displays the alarm queue;
- Help** in the "manufacturer" level, when scrolling the parameters, shows the help screens.

### Modalità di connessioni e alimentazione tLAN, pLAN e RS485 tLAN, pLAN and RS485 connections and power supply

Caso 1: applicazione di più driver collegati in rete, all'interno dello stesso quadro elettrico, alimentati dallo stesso trasformatore  
Case 1: a series of drivers is connected in a network, installed in the same electrical panel, powered by the same transformer

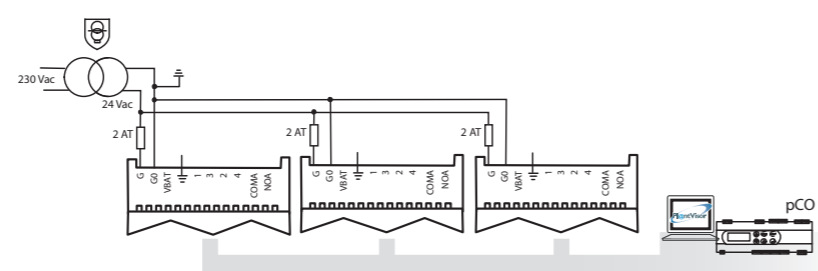

Caso 2: applicazione di più driver collegati in rete, all'interno di quadri elettrici diversi, alimentati da trasformatori diversi (G0 non connesso a terra).  
Case 2: a series of drivers is connected in a network, installed in electrical different panels, powered by different transformers (G0 not connected to earth).

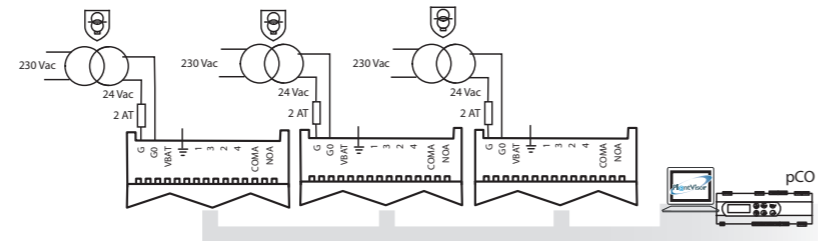

Caso 3: applicazione di più driver collegati in rete, all'interno di quadri elettrici diversi, alimentati da trasformatori diversi con un unico punto di messa a terra.  
Case 3: a series of drivers is connected in a network, installed in electrical different panels, powered by different transformers with just one earth point.

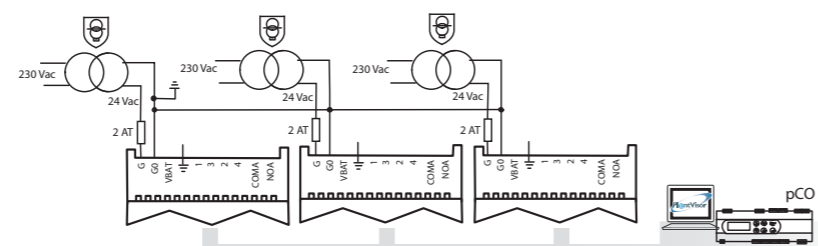

CASO 1/ CASE 1:  
alimentazione 230 Vac con modulo di emergenza/  
230 Vac power supply with emergency module

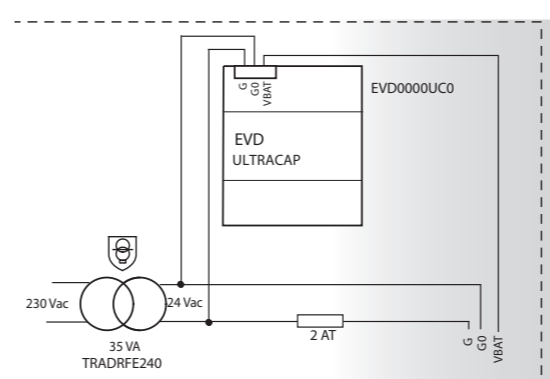

CASO 2 / CASE 2  
alimentazione 230 Vac senza  
modulo di emergenza/ 230  
Vac power supply without  
emergency module

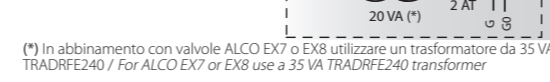

(\* In abbinamento con valvole ALCO EX7 o EX8 utilizzare un trasformatore da 35 VA TRADRFE240 / For ALCO EX7 or EX8 use a 35 VA TRADRFE240 transformer

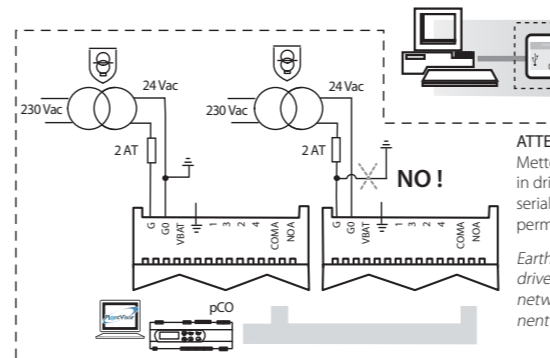

CASO 3/ CASE 3:  
alimentazione 24 Vdc/  
24 Vdc power supply

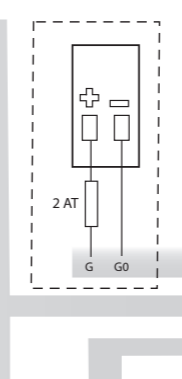

### Schema elettrico per il controllo del surriscaldamento / Wiring diagram for superheat control

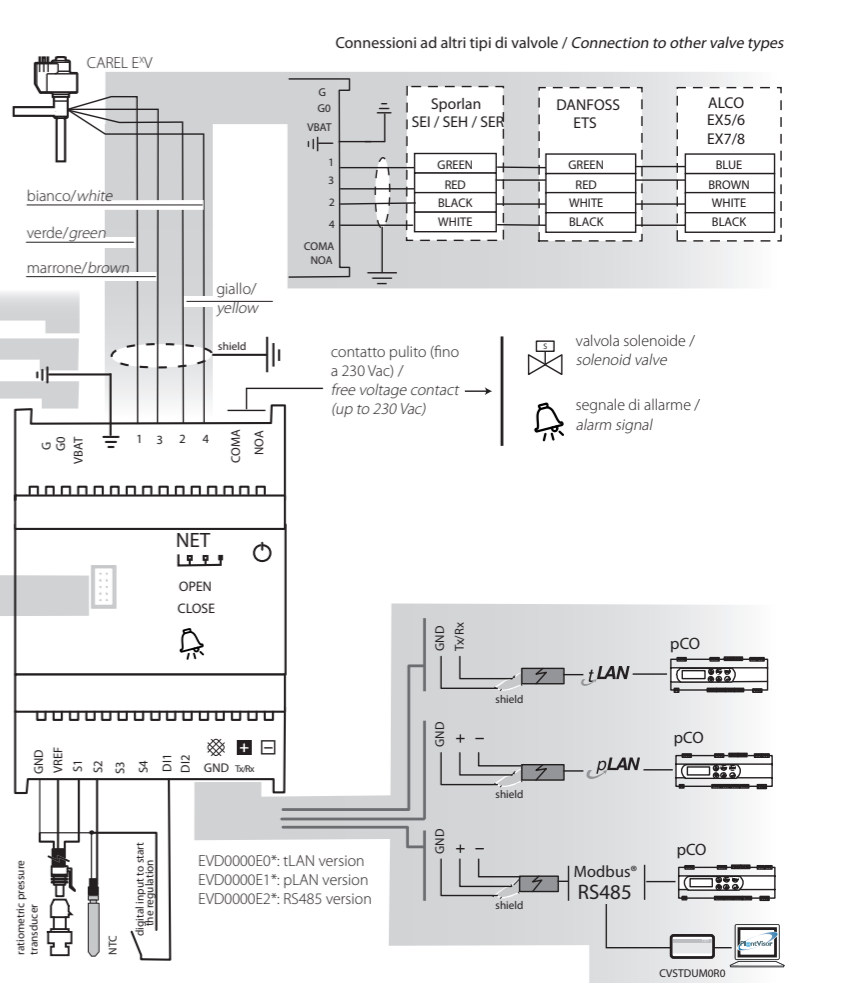

NOTA 1: utilizzare un trasformatore di sicurezza in classe 2, adeguatamente protetto da cortocircuito e sovraccarico / Use a class 2 safety transformer, suitably protected against short-circuits and voltage surges

### ITA Impostazione dei parametri base

- appare il primo parametro: indirizzo di rete;
- premere UP/DOWN per modificare il valore;
- premere Enter per passare al valore del parametro
- premere Enter per confermare il valore
- premere UP/DOWN per passare al parametro successivo, refrigerante
- ripetere i passi 2, 3, 4, 5 per modificare i valori dei parametri: refrigerante, valvola, sonda pressione S1, regolazione principale;
- verificare la correttezza dei collegamenti elettrici;
- se la configurazione è corretta uscire dalla procedura, altrimenti scegliere NO e ritornare al passo 2;

### ENG Setting the basic parameters

- the first parameter is displayed: network address;
- press Enter to show the value of the parameter
- press UP/DOWN to change the value
- press Enter to confirm the value
- press UP/DOWN to move to the next parameter, refrigerant
- repeat steps 2, 3, 4, 5 to change the values of the parameters: refrigerant, valve, pressure sensor S1, main type of control;
- check that the electrical connections are correct;
- if the configuration is correct, exit the procedure, otherwise choose NO and return to step 2;

### CHI 设定基本参数

- 显示第一个参数: 网络地址;
- 按下Enter键显示参数值
- 按下UP/DOWN键, 改变参数值
- 按下Enter键确认值
- 重复步骤2, 3, 4, 5, 改变参数的值: 制冷剂, 阀, 压力传感器S1, 控制的主要类型;
- 检查电气连接是否正确;
- 如果设置正确, 退出程序, 否则选择NO并返回到步骤2;

### RUS Установка основных параметров

- первый показываемый параметр: сетевой адрес;
- нажмите Enter для индикации значения параметра
- нажмите UP/DOWN для изменения значения
- нажмите Enter для подтверждения значения
- нажмите UP/DOWN для перехода к следующему параметру, хладагент
- повторите шаги 2, 3, 4, 5 для изменения значений параметров: хладагент, клапан, датчик давления S1, главный тип управления;
- проверьте правильность электрических соединений;
- если конфигурация правильная, выйдите из процедуры, в противном случае выберите NO и перейдите к шагу 2;

**ITA** Il driver EVD evolution per valvola di espansione elettronica a motore passo-passo bipolare è un controllore PID per la regolazione del surriscaldamento del refrigerante in un circuito frigorifero. Tramite il display (accessorio) è possibile eseguire la messa in servizio del driver, ma non è necessario per il funzionamento dello stesso. La configurazione del driver può essere effettuata anche tramite computer, utilizzando il software CAREL VPM (Visual Parameter Manager), disponibile sul sito http://ksa.carel.com. Il driver può essere collegato ad un controllore CAREL della serie pCO via seriale, oppure può essere connesso ad un supervisore CAREL PlantVisorPRO.

**▲Avvertenze per l'installazione:**
1. effettuare tutte le operazioni di installazione e manutenzione con driver non alimentato;
2. evitare cortocircuiti tra i pin G, G0 e Vbat.

- \*EVD EVO è un controllo da incorporare nell'apparecchiatura finale, non usare per montaggio a muro.
- \* DIN VDE 0100: Deve essere garantita la separazione protettiva tra i circuiti SELV e gli altri circuiti. Per prevenire la violazione della separazione di protezione (tra i circuiti SELV e gli altri circuiti) è necessario provvedere ad un fissaggio aggiuntivo vicino alle terminazioni. Questo fissaggio aggiuntivo deve serrare l'isolante e non i conduttori.

**Ingressi e uscite**

Si raccomanda di tenere separati i cavi degli ingressi/uscite e del relè dal cavo di alimentazione della valvola. Tutti gli ingressi analogici, gli I/O digitali e le seriali (non optoisolate) sono riferiti alla massa GND, quindi l'applicazione, anche temporanea, di tensioni superiori a ±5 V a questi collegamenti può causare un danno ir-reversibile al driver. Essendo GND la massa comune per tutti gli ingressi è preferibile replicarla in morsetteria.
**Prima messa in servizio**
Alimentare il driver, il display si illuminerà e in caso di prima messa in servizio, il display guida l'installatore nell'immissione dei 4 parametri necessari all'avvio: tipo refrigerante, tipo valvola, tipo sonda di pressione tipo di regolazione principale (indirizzo di rete se necessario).

Nel caso in cui EVD evolution e display abbiano versioni firmware diverse, apparirà un messaggio di avvertimento. Per la procedura di aggiornamento firmware riferirsi al manuale d'uso .
Finché la procedura di configurazione non è terminata il driver non può funzionare.

**Procedure di UPLOAD, DOWNLOAD e RESET parametri (display)**

▲ Le procedure devono essere eseguite con il/i driver alimentati.

NON rimuovere il display dal driver durante le procedure di UPLOAD, DOWNLOAD, RESET.

- premere contemporaneamente i tasti Help e Enter per 5 s;
- si entra in un menu a scelta multipla, selezionare con UP/DOWN la procedura desiderata;
- confermare con ENTER.

**UPLOAD:** il display memorizza tutti i valori dei parametri del driver 1 (origine).

**DOWNLOAD:** il display copia tutti i valori dei parametri nel driver 2 (destinazione); è inibito il download dei parametri se il driver di origine e il driver di destinazione hanno firmware incompatibili.

**RESET:** tutti i parametri del driver sono riportati ai valori di fabbrica. Vedere la tabella parametri sul manuale d'uso del driver.

<b>Caratteristiche tecniche</b>	
Alimentazione (Lmax=5 m)	24 Vdc (+10/-15%) da proteggere con fusibile esterno di tipo T da 2 A <p>24 Vac (+10/-15%) 50/60 Hz da proteggere con fusibile esterno di tipo T da 2 A. Utilizzare un trasformatore dedicato (max 100 VA) in classe II.</p> <p>16,2 W con valvole ALCO EX7/EX8; 9,2 W con tutte le altre valvole</p> <p>35 VA con EVD0000UC0; 35 VA con valvole ALCO EX7/EX8; 20 VA senza EVD0000UC0 e con tutte le altre valvole</p>
Potenza di assorbimento	
Alimentazione di emergenza	22Vdc+/-5%. (Se installato il modulo opzionale EVD0000UC0). Lmax= 5 m <p>rinforzato; 6 mm in aria, 8 superficiali; 3750 V isolamento</p>
Collegamento motore	cavo schermato a 4 poli CAREL codice E2VCABS*00, oppure cavo schermato a 4 poli AWG22 Lmax=10 m, oppure cavo schermato a 4 poli AWG14 Lmax= 50 m
Collegamento ingressi digitali	Ingresso digitale da azionare con contatto pulito o transistor verso GND. Corrente di chiusura 5mA; Lmax< 30 m
Sonde (Lmax=10 m; inferiore a 30 m con cavo schermato)	S1 <p>sonda pressione raziometrica (0...5 V): • risoluzione 0,1<span> </span>% fs; • errore di misura: 2% fs massimo; 1% tipico</p> <p>sonda pressione elettronica (4...20 mA): • risoluzione 0,5<span> </span>% fs; • errore di misura: 8% fs massimo; 7% tipico</p> <p>sonda pressione raziometrica combinata (0...5V): • risoluzione 0,1<span> </span>% fs; • errore di misura: 2<span> </span>% fs massimo; 1<span> </span>% tipico</p> <p>Ingresso 4...20 mA (max 24 mA): • risoluzione 0,5<span> </span>% fs; • errore di misura: 8<span> </span>% fs massimo; 7<span> </span>% tipico</p> <p>S2 <p>NTC bassa temperatura: • 10 kΩ a 25<span> </span>°C, -50T90<span> </span>°C; • errore di misura: 1°<span> </span>C nel range -50T50<span> </span>°C; 3°<span> </span>C nel range +50T90<span> </span>°C</p> <p>NTC alta temperatura: • 50 kΩ a 25<span> </span>°C, -40T150<span> </span>°C; • errore di misura: 1,5°<span> </span>C nel range -20T115<span> </span>°C, 4°<span> </span>C nel range esterno a -20T115<span> </span>°C</p> <p>NTC combinata: • 10 kΩ a 25<span> </span>°C, -40T120<span> </span>°C; • errore di misura: 1°<span> </span>C nel range -40T50<span> </span>°C; 3°<span> </span>C nel range +50T90<span> </span>°C</p> <p>Ingresso 0...10 V (max 12 V): • risoluzione 0,1% fs; • errore di misura: 9% fs massimo; 8% tipico</p> <p>S3 <p>sonda pressione raziometrica (0...5 V): • risoluzione 0,1% fs; • errore di misura: 2% fs massimo; 1% tipico</p> <p>sonda pressione elettronica (4...20 mA): • risoluzione 0,5% fs; • errore di misura: 8% fs massimo; 7% tipico</p> <p>sonda pressione elettronica (4...20 mA) remota. Numero massimo di controlli connettabili=5</p> <p>sonda pressione raziometrica combinata (0...5V): • risoluzione 0,1<span> </span>% fs, • errore di misura: 2<span> </span>% fs massimo; 1<span> </span>% tipico</p> <p>S4 <p>NTC bassa temperatura: • 10 kΩ a 25<span> </span>°C, -50T105<span> </span>°C; • errore di misura: 1°<span> </span>C nel range -50T50<span> </span>°C; 3°<span> </span>C nel range +50T90<span> </span>°C</p> <p>NTC alta temperatura: • 50 kΩ a 25<span> </span>°C, -40T150<span> </span>°C; • errore di misura: 1,5°<span> </span>C nel range -20T115<span> </span>°C; 4°<span> </span>C nel range esterno a -20T115<span> </span>°C</p> <p>NTC combinata: • 10 kΩ a 25<span> </span>°C, -40T120<span> </span>°C; • errore di misura 1°<span> </span>C nel range -40T50<span> </span>°C; 3°<span> </span>C nel range +50T90<span> </span>°C</p></p></p></p>
Uscita relè	contatto normalmente aperto; 5 A, 250 Vac carico resistivo; 2 A, 250 Vac carico induttivo (PF=0.4); Lmax=50 m; UL: 250 Vac, 5 A res, 1A FLA, 6 A LRA, D300 pilot duty, 30.000 cicli; VDE: 1(1)A PF=0.6
Alimentazione sonde attive (V <sub>bat</sub> )	uscita programmabile: +5 Vdc+/-2% o 12Vdc+/-10%
Collegamento seriale RS485	Lmax= 1000 m, cavo schermato
Collegamento tLAN	Lmax= 30 m, cavo schermato
Collegamento pLAN	Lmax= 500 m, cavo schermato
Montaggio	su guida DIN
Connettori	estraiibili, sezione cavi 0,5...2,5 mm² (12...20 AWG)
Dimensioni	LxHxW= 70x110x60 mm
Condizioni di funzionamento	-25T60°C (non usare EVDIS* sotto -20°C); <90% U.R. non condensante
Condizioni di immagazzinamento	-35T60°C (non stoccare EVDIS* sotto -30°C); umidità 90% U.R. non cond.
Grado di protezione	IP20
Inquinamento ambientale	2
Resistenza al calore e al fuoco	Categoria D
Immunità contro le sovratensioni	Classe II
Tensione impulsiva nominale	2500V
Tipo di azione relè	1C micro interruzione del funzionamento
Classe di isolamento	II
Classe e struttura del software	A
Conformità	Sicurezza elettrica: EN 60730-1, EN 61010-1; UL873, VDE 0631-1 <p>Compatibilità elettromagnetica: EN 61000-6-1, EN 61000-6-2, EN 61000-6-3, EN 61000-6-4; EN61000-3-2, EN55014-1, EN55014-2, EN61000-3-3.</p>

CAREL INDUSTRIES HQs

Via dell'Industria, 11 - 35020 Brugine - Padova (Italy)

Tel. (+39) 0499716611 – Fax (+39) 0499716600 – http://www.carel.com – e-mail: carel@carel.com

**ENG** The EVD evolution driver for electronic expansion valves with two-pole stepper motor is a PID controller that manages the superheat of the refrigerant in a refrigerant circuit. The display (accessory) can be used for setting up the driver, but is not required for operation. The driver can also be configured from a computer, using the CAREL VPM software (Visual Parameter Manager), available at http://ksa.carel.com. The driver can be connected to a CAREL pCO series controller via serial link, or can be connected to a CAREL PlantVisorPRO supervisor.

**▲ Installation warnings:**
1. all installation and maintenance operations must be performed with the driver powered down;
2. avoid short-circuits between pins G, G0 & Vbat.

- \*EVD EVO is a control to be incorporated in the end equipment, do not use for flush mount.
- \* DIN VDE 0100: Protective separation between SELV circuit and other circuits must be guaranteed. To prevent infringement of the protective separation (between SELV circuit to other circuits) an additional fixing has to be provided near to the terminals. This additional fixing shall clamp the insulation and not the conductor"

**Inputs and outputs**

It is recommended to keep the input/output and relay cables separate from the valve power cable. All the analogue inputs, the digital I/Os and the serial ports (not optically isolated) refer to GND, and consequently applying, even temporarily, voltages greater than ±5 V to these connections may cause a irreversible damage to the driver. As GND is the common earth for all the inputs, this should be replicated on the terminal block.

**Commissioning**

Power up the driver, the display will come on and when starting for the first time, will guide the installer through the entry of the 4 parameters required to start operation: type of refrigerant, type of valve, type of pressure sensor, type of main control (and network address if necessary). If the EVD evolution and display have different firmware versions, a warning message will be displayed. To update the firmware see the user manual. The driver cannot operate until the configuration procedure has been completed.

**UPLOAD, DOWNLOAD and RESET parameters procedure (display)**

▲ The procedure must be carried out with the driver/drivers connected to the power supply.

DO NOT unplug the display from the driver during UPLOAD, DOWNLOAD or RESET procedures.

- press the Help and Enter buttons together for 5 seconds;
- This accesses a multiple choice menu, use UP/DOWN to select the required procedure;
- confirm by pressing ENTER.

**UPLOAD:** the display saves all the values of the parameters from driver 1 (source).

**DOWNLOAD:** the display copies all the values of the parameters to driver 2 (destination); the parameters cannot be downloaded if the firmware on the source and destination drivers is incompatible.

**RESET:** all the driver parameters are returned to the default values. See the table of parameters in the driver user manual.

**Technical specifications**

Power supply (Lmax=5 m)	24 Vdc (+10/-15%) to be protected by 2 A external type T fuse. <p>24 Vac (+10/-15%) 50/60 Hz to be protected by 2 A external type T fuse. Use a dedicated class 2 transformer (max 100 VA).</p>
Power input	16,2 W with ALCO EX7/EX8 valves; 9,2 W with all other valves <p>35 VA with EVD0000UC0; 35 VA with ALCO EX7/EX8 valves; 20 VA without EVD0000UC0 and with all other valves</p>
Emergency power supply	22Vdc+/-5%. (If optional module EVD0000UC0/500 is installed), Lmax= 5 m <p>reinforced; 6 mm in air, 8 mm on surface; 3750 V insulation</p>
Insulation between relay output and other outputs	
Motor connection	CAREL 4-wire shielded cable code E2VCABS*00, or 4-wire shielded cable AWG22 Lmax 10 m, or 4-wire shielded cable AWG14 Lmax 50 m
Digital input connection	Digital input to be activated from free contact or transistor to GND. Closing current 5mA; Lmax< 30 m
Sensors (Lmax=10 m; less than 30 m with shielded cable)	S1 <p>ratimetric pressure sensor (0 to 5 V): • resolution 0.1<span> </span>% FS; • measur. error: 2% FS max; 1% typical</p> <p>electronic pressure sensor (4 to 20 mA): • resolution 0.5<span> </span>% FS; • measur. error: 8% FS max; 7% typical</p> <p>combined ratimetric pressure sensor (0 to 5 V): • resolution 0.1<span> </span>% FS; • measur. error: 2<span> </span>% FS maximum; 1<span> </span>% typical</p> <p>4 to 20 mA input (max 24 mA): • resol. 0.5<span> </span>% FS; • measur. error: 8% FS max; 7% typical</p> <p>S2 <p>low temperature NTC: • 10kΩ at 25°C, -50T90°C; • measur. error: 1°<span> </span>C in range -50T50°C; 3°<span> </span>C in range +50T90°C</p> <p>high temperature NTC: • 50kΩ at 25°C, -40T150°C; • measur. error: 1.5°<span> </span>C in the range -20T115°C, 4°<span> </span>C in range outside of -20T115°C</p> <p>combined NTC: • 10kΩ at 25°C, -40T120°C; • measur. error: 1°<span> </span>C in range -40T50°C; 3°<span> </span>C in range +50T90°C</p> <p>S3 <p>ratimetric pressure sensor (0 to 5 V): • resol. 0.1<span> </span>% FS; • measur. error: 2% FS max; 1% typical</p> <p>electronic pressure sensor (4 to 20 mA): • resolution 0.5<span> </span>% FS; • measur. error: 8% FS max; 7% typical</p> <p>remote electronic pressure sensor (4 to 20 mA). Max number of controllers connected=5</p> <p>ratimetric pressure sensor combined (0 to 5 V): • resolution 0.1<span> </span>% FS, • measurement error: 2<span> </span>% FS maximum; 1<span> </span>% typical</p> <p>S4 <p>low temperature NTC: • 10kΩ at 25°C, -50T105°C; • measur. error: 1°<span> </span>C in range -50T50<span> </span>°C; 3°<span> </span>C in range 50T90°C</p> <p>high temperature NTC: • 50kΩ at 25°C, -40T150°C; • measur. error: 1.5°<span> </span>C in range -20T115°C 4°<span> </span>C in range outside of -20T115°C</p> <p>combined NTC: • 10kΩ at 25°C, -40T120°C; • measur. error: 1°<span> </span>C in range -40T50°C; 3°<span> </span>C in range +50T90°C</p></p></p></p>
Relay output	normally open contact; 5 A, 250 Vac resistive load; 2 A, 250 Vac inductive load (PF=0.4); Lmax=50 m; UL: 250 Vac, 5 A res, 1A FLA, 6 A LRA, D300 pilot duty, 30.000 cycles; VDE: 1(1) A PF=0.6
Power to active sensors (V <sub>bat</sub> )	programmable output: +5Vdc+/-2% or 12Vdc+/-10%
RS485 serial connection	Lmax=1000 m, shielded cable
tLAN connection	Lmax=30 m, shielded cable
pLAN connection	Lmax=500 m, shielded cable
Assembly	DIN railn
Connectors	plug-in, cable size 0.5 to 2.5 mm2 (12 to 20 AWG)
Dimensions	LxHxW= 70x110x60 mm
Operating conditions	-25T60°C (don't use EVDIS* under -20°C); <90% rH non-condensing
Storage conditions	-35T60°C (don't store EVDIS* under -30°C), humidity 90% rH non-condensing
Index of protection	IP20
Environmental pollution	2
Resistance to heat and fire	Category D
Immunity against voltage surges	Class 2
Rated impulse voltage	2500V
Relay action type	1C微型开关
绝缘类型	2
软件分类和结构	A
规范	电气安全: EN 60730-1, EN 61010-1, UL873, VDE 0631-1 <p>电磁兼容: EN 61000-6-1, EN 61000-6-2, EN 61000-6-3, EN 61000-6-4; EN61000-3-2, EN55014-1, EN55014-2, EN61000-3-3</p>

**CHI** EVD 驱动器驱动器适用于2极步进电机的电子膨胀阀，是一种 PID 控制器，能管理一个制冷回路的吸气过热度。显示屏（配件）能被用来安装在驱动器上，不是运行所必须的。使用 CAREL VPM（图像参数管理器）软件，驱动器还能通过一台计算机来设置，该软件可从卡乐网站获取，http://ksa.carel.com. 通过串行连接，驱动器还能与 CAREL pCO 系列控制器连接，或连接到 CAREL PlantVisorPRO 监视器。

**▲ 安装警告:**
1. 所有安装和维护工作必须在驱动器未通电时进行;
2. 避免G, G0 & Vbat之间短路.

\* EVD EVO是一个要并入终端装置的控制器的，请勿用于嵌入式安装。

- \* DIN VDE 0100: 必须保证SELV回路与其它回路之间的保护隔离。为防止对保护隔离的破坏 (SELV 回路与其它回路之间)，在连接端附近必须采用附加的固定措施。这种附加的固定措施需要夹紧绝缘而不是导线。

**输入和输出**

建议将输入、输出和继电器电缆与阀电源线分开。所有的模拟量输入，开关量输入/输出和串行端口（非光学隔离）参考GND。如果在这些端子上施加的电压远超过可能导致对驱动器不可恢复的损坏。因为GND是所有输入的共同接地端，因此必须使用螺栓端子排。

**指令**

驱动器通电，显示屏将开始显示，并且当第一次启动时，将指导安装商进入启动运行的4个参数：制冷剂类型，阀类型，压力传感器类型，控制主要类型（网络地址如有必要）。EVD evolution和显示屏有不同的硬件版本，将显示一个报警信息。要更新硬件，参考用户手册，代码+03022204\*。

驱动器不能运行直到设置程序已经完成.

**上载，下载和复位参数的程序（显示器）**

▲ 这项操作必须在驱动器带电的情况下才能进行。

不要在上载，下载或复位的过程中将显示器从驱动器上拿下.

- 同时按下Help和Enter键保持5秒;
- 进入到一个多选项菜单，使用UP/DOWN键来选择所需的程序;
- 按下ENTER键确认.

上载: 显示器保存驱动器 1（源头）上的所有的参数值.

下载: 显示器将所有的参数值复制到驱动器2（终点）；源驱动器与目标驱动器硬件不兼容，参数不能下载.

复位: 所有驱动器参数能返回到默认值。参考驱动器中的参数表.

<b>技术规范</b>	
电源（最大长度为5 m。）	24 Vdc (+10/-15%)，由2 A T 型保险丝保护。 <p>24 Vac (+10/-15%) 50/60 Hz，由2 A T 型保险丝保护。使用一个专用的2 类变压器（最大为100 VA)。</p>
输入功率	ALCO EX7/EX8系列膨胀阀: 16.2W 其他膨胀阀: 9.2W <p>如使用EVD0000UC0: 35VA; 不使用EVD0000UC0，ALCO EX7/EX8系列膨胀阀: 35VA 其他膨胀阀: 20VA</p>
备用电池	22 Vdc +/- 5%。（如果安装了可选的EVD0000UC0/500模块，最大长度为= 5 m
继电器输出和其它输出之间的绝缘	绝缘；空间传导，6 mm，爬行距离，8 mm
电机连接	CAREL 4芯屏蔽电缆 产品代码 E2VCABS*00，或者4芯屏蔽电缆AWG22 最大长度17u0 m，或者4芯屏蔽电缆AWG14 最大长度50m <p>通过将无源触点或晶体管接至GND 激活开关量输入；最大长度&lt; 30 m</p> <p>公制比率压力传感器 (0 - 5 V)；精度 0.1<span> </span>% FS；测量误差：最大为2% FS；通常是1%</p> <p>电子压力传感器 (4 - 20 mA)；精度0.5<span> </span>% FS；测量误差：最大为8% FS；通常是7%</p> <p>组合式公制比率压力传感器 (0 - 5 V)；精度0.1<span> </span>% FS；测量误差：最大为2<span> </span>% FS；通常是1%</p> <p>4–20 mA V 输入（最大为24 mA）；精度0.5<span> </span>% FS；测量误差：最大为8<span> </span>% FS；通常是7<span> </span>%</p> <p>S1 <p>低温NTC传感器：在25°C 时是10kΩ，-50到90°C；测量误差：在-50到50°C 之间是1°C；在+50到90°C 之间是3°C</p> <p>高温NTC传感器：在25°C 时是50kΩ，-40到150°C；测量误差：在-20到115°C 之间是1.5°C；-20到115°C 以外是4°C</p> <p>组合式NTC传感器：在25°C 时是10kΩ，-40到120°C；测量误差：在-40到50°C 之间是1°C；在+50到90°C 之间是3°C</p> <p>0 - 10 V 输入（最大为12 V)；精度0.1<span> </span>% FS；测量误差：最大为9% FS；通常是8% typical</p> <p>S2 <p>公制比率压力传感器 (0 - 5 V)；精度 0.1<span> </span>% FS；测量误差：最大为2% FS；通常是1%</p> <p>电子压力传感器 (4 - 20 mA)；精度0.5<span> </span>% FS；测量误差：最大为8% FS；通常是7%</p> <p>远程电子压力传感器 (4 - 20 mA)。最多可连接传感器=5</p> <p>组合式公制比率压力传感器 (0 - 5 V)；精度0.1<span> </span>% FS；测量误差：最大为2% FS；通常是1%</p> <p>S3 <p>低温NTC传感器：在25°C 时是10kΩ，-50到105°C；测量误差：在-50到50 °C 之间是1°C；在50到90°C 之间是3°C</p> <p>高温NTC传感器：在25°C 时是50kΩ，-40到150°C；测量误差：在-20到115°C 之间是1.5°C；在-20到115°C 以外是4°C</p> <p>组合式NTC传感器：在25°C 时是10kΩ，-40到120°C；测量误差：在-40到50°C 之间是1°C；在+50到90°C 之间是3°C</p> <p>常开触点， 5 A，250 Vac阻性负载；2 A，250 Vac；感性负载 (PF=0.4；最大长度=50 m; UL: 250 Vac, 5 A 阻性负载, 1A FLA, 6 A LRA, D300 抗电强度 30, 000 次；VDE: 1(1)A PF=0.6</p> <p>S4 <p>可编辑输出: +5Vdc+/-2% 或 12Vdc+/-10%</p> <p>最大长度=1000 m，屏蔽电缆</p> <p>最大长度=30 m，屏蔽电缆</p> <p>最大长度=500 m，屏蔽电缆</p> <p>安装</p> <p>DIN 导轨</p> <p>端子</p> <p>插拔式，电缆尺寸0.5 - 2.5 mm² (12 - 20 AWG)</p> <p>尺寸</p> <p>LxHxW= 70x110x60 mm</p> <p>运行条件</p> <p>-25–60°C (在低于-20°C时，请勿使用EVDIS*)；&lt;90% rH，无冷凝</p> <p>存储条件</p> <p>-35–60°C (在低于-30°C时，请勿使用EVDIS*)，湿度90% rH，无冷凝</p> <p>防护等级</p> <p>IP20</p> <p>2</p> <p>D类</p> <p>2类</p> <p>2500V</p> <p>1C微型开关</p> <p>2</p> <p>A</p> <p>电气安全: EN 60730-1, EN 61010-1, UL873, VDE 0631-1</p> <p>电磁兼容: EN 61000-6-1, EN 61000-6-2, EN 61000-6-3, EN 61000-6-4; EN61000-3-2, EN55014-1, EN55014-2, EN61000-3-3</p></p></p></p></p>
继电器输出	
有源传感电源 (V <sub>bat</sub> )	可编辑输出: +5Vdc+/-2% 或 12Vdc+/-10%
RS485串行连接	最大长度=1000 m，屏蔽电缆
tLAN串行连接	最大长度=30 m，屏蔽电缆
pLAN串行连接	最大长度=500 m，屏蔽电缆
安装	DIN 导轨
端子	插拔式，电缆尺寸0.5 - 2.5 mm² (12 - 20 AWG)
尺寸	LxHxW= 70x110x60 mm
运行条件	-25–60°C (在低于-20°C时，请勿使用EVDIS*)；<90% rH，无冷凝
存储条件	-35–60°C (在低于-30°C时，请勿使用EVDIS*)，湿度90% rH，无冷凝
防护等级	IP20
环境污染	2
隔热及阻燃类别	D类
抗浪涌	2类
Rated impulse voltage	2500V
继电器动作类型	1C微型开关
绝缘类型	2
软件分类和结构	A
规范	电气安全: EN 60730-1, EN 61010-1, UL873, VDE 0631-1 <p>电磁兼容: EN 61000-6-1, EN 61000-6-2, EN 61000-6-3, EN 61000-6-4; EN61000-3-2, EN55014-1, EN55014-2, EN61000-3-3</p>

**RUS** Драйвер EVD evolution для электронных расширительных клапанов с шаговым двигателем является PID контроллером, который управляет перегревом в контуре хладагента. Дисплей может использоваться для установки параметров драйвера, но не является обязательным в процессе работы. Драйвер можно конфигурировать с компьютера с помощью программного обеспечения (ПО) CAREL VPM (Visual Parameter Manager); программу можно загрузить с http://ksa.carel.com. Драйвер подключается к контроллерам CAREL серии pCO через последовательное соединение, а также может быть подключен к системе мониторинга CAREL PlantVisorPRO.

**▲ Особенности монтажа:**
1. установка и монтаж должны осуществляться при выключенном драйвере;
2. не допускать короткого замыкания контактов G, G0 и Vbat.

- \*EVD EVO является драйвером, встроенным в оконечное оборудование, не используется для скрытого монтажа.
- \* DIN VDE 0100: Должно быть предусмотрено защитное разделение между контурами SELV и другими контурами. Для предотвращения повреждения защитного разделения (между контролем SELV и другими контурами) необходимо предусмотреть рядом с выводами защитный крепеж. Данный дополнительный крепеж фиксирует изоляцию, а не проводник".

**Входы и выходы**

Рекомендуется отделить кабели вход/выход и реле от кабеля питания клапана. Не допускается подча напряжения, даже временно, более ±5 В на все аналоговые входы, цифровые входы/выходы и последовательные порты (без оптической изоляции); это может вызвать необратимое повреждение драйвера. GND - общее заземление для всех входов, аналогично должно быть и на терминальном блоке.

**Включение**

При первом включении драйвера, на дисплее появляются подсказки как ввести 4 параметра, необходимых для начала работы: тип хладагента, тип клапана, тип датчика давления, способ управления ( а также сетевой адрес устройства при необходимости). Если EVD evolution и дисплей имеют разные версии встроенного программного обеспечения (ПО), на экране появится предупреждение. Для обновления программного обеспечения см. руководство пользователя. Драйвер не будет работать пока не закончена процедура конфигурирования.

**Процедура загрузки, выгрузки и восстановления параметров (дисплей)**

▲ Процедура должна выполняться при включенном драйвере/драйверах. НЕ ОТКЛЮЧАЙТЕ дисплей от драйвера во время процедуры ЗАГРУЗКИ, ВЫГРУЗКИ или ВОССТАНОВЛЕНИЯ параметров.

- нажмите и удерживайте в течение 5 секунд вместе кнопки Help и Enter;
- это дает доступ в меню множественного выбора, используйте кнопки UP/DOWN для выбора необходимой процедуры;
- подтвердите, нажав кнопку ENTER.

**ВЫГРУЗКА:** дисплей сохраняет все параметры драйвера 1 (источника).

**ЗАГРУЗКА:** дисплей копирует все значения параметров в драйвер 2 (получатель); параметры не могут быть загружены, если встроенные ПО источника и получателя несовместимы.

**ВОССТАНОВЛЕНИЕ:** все параметры драйвера принимают значения по умолчанию. См. таблицу параметров в руководстве пользователя драйвера.

**Техническая спецификация**

Электропитание (Lmax=5 m)	24 Vdc (+10/-15%) защита внешним предохранителем 2 A <p>24 Vac (+10/-15%) 50/60 Hz, защита внешним предохранителем 2 A.</p> <p>Использовать трансформатор 2 класса (max 100 VA).</p> <p>16,2 W с ТРВ моделий ALCO EX7/EX8; 9,2 W и со всеми другими моделями ТРВ</p> <p>35 ВА с EVD0000UC0; 35 ВА с ТРВ моделий ALCO EX7/EX8; 20 ВА без EVD0000UC0 и со всеми другими моделями ТРВ</p>
Входная мощность	22Vdc+/-5%. (если установлен дополнительный модуль EVD0000UC0/500), Lmax= 5 m
Аварийная мощность	
Изоляция между выход	