

Control pressure switch MDR - F



- 1 SPDT / 2 DPDT - Normally Open / Normally Closed (NO/NC)
- Pressure range up to 250 bar
- GL / VdS / UL approvals -optional
- Scale for simple adjustments
- Wide range of variations
- Acc. to EN 60947

Applications:

Air pressure technology, water pressure technology, construction machinery, water-based extinguishing systems, fire protection units, oil pressure monitoring, mining, chemical, industry, railway vehicles, offshore, shipping, vacuum technology, calibration technology, heating systems

Specific applied approval



MDR – F ..H-S

Application

The Condor pressure switch series MDR-F can be **universally used** and are suitable for:

- **Monitoring and controlling the pressure of liquids or gaseous media** in pipelines, tanks, vats, pressure vessels and installations.
- **Tasks in process control**, cooling, pneumatics and hydraulics.
- **Pressure monitoring of cooling circuits and lubrication systems** on various types of machinery.
- **Automatic switching of pump and compressor motors** for supplying water to dwellings, booster pumps, fire-fighting equipment and on compressed air systems.

Mode of operation:

The pressure of the monitored medium operates against a diaphragm, bellows or a plunger all of which have different media resistance. Switching operation is carried out with the use of a micro switch ensuring flutter-free switching

When the pressure reaches the upper switching point, the micro switch contacts change position. In normal cases e.g. a connected motor is switched off (up to 550 watts direct or using additional switches like a contactor etc.). Should the pressure fall below the lower switch point, then the micro switch contact returns to its default position and the motor is switched on.

The upper and lower switching points can be set independently using a screw driver. Both switching points can be read off the scale.

Pressure connection, pressure sensing element and electrical connections are all fitted on to a die-cast aluminum base. The sealable transparent, polycarbonate cover protects the scales and switch against environmental effects.

Standard scope of delivery:

- rubber grommets
- MDR-F..H Die-cast aluminum flange
- MDR-F..Y Plastic flange (in particular for use in water technology applications)
- **With industrial screw connection**
(Industrial clamp version available upon request)

Besides the standard types with Perbunan diaphragms, the following new types are available:

- **Pressure switch with stainless steel pressure sensing element** e.g. for liquid fuels, oils up to 200°C etc.
- **High pressure switch with plastic plunger press. sensing element** with stainless steel connection up to 250 bar
- **Pressure switch with manual reset function and die-cast aluminum flange** for oil, water and air etc.
- **Pressure switch with Viton diaphragm and die-cast aluminum flange** for increased media resistance
- **Pressure switch with VdS approval** for fire-extinguishing systems / fire protection-installations
- **Pressure switch with GL approval** for ship building and applications intended for use at sea
- **Pressure switch with Atex approval** in mining and chemicals plants that are at risk of explosion
- **Pressure switch with UL approval** for the North American market
- **Vacuum**
- **DPDT**

The MDR-F pressure switch program is extended continuously. A current status of the existing designs and approvals is available on our homepage.

Control pressure switch MDR - F

MDR-F standard version with die-cast aluminium flange



MDR-F standard version with die-cast aluminium flange and Perbunan diaphragm - for oil, water and air etc. . Pressure switch with industrial cage clamp version.
 Connection: H G 3/8" inner thread **
 - suffix "G" for gold-flashed contacts

Order reference	Type Code	Adjustable cut-in pressure (bar)	Smallest pressure diff. (bar)*	Adjustable cut-out pressure (bar)	Weight (in g)	Part No.
MDR-F 2H-S	MDR-F 2 HAA SAA A 005A015	0,04 ... 1,89	0,07 0,11	0,11 ... 2	460	253501
MDR-F 2HG-S	MDR-F 2 HAA SBA A 005A015	0,04 ... 1,89	0,07 0,11	0,11 ... 2	460	253518
MDR-F 4H-S	MDR-F 4 HAA SAA A 010A030	0,07 ... 3,75	0,15 0,25	0,22 ... 4	460	253525
MDR-F 4HG-S	MDR-F 4 HAA SBA A 010A030	0,07 ... 3,75	0,15 0,25	0,22 ... 4	460	253532
MDR-F 8H-S	MDR-F 8 HAA SAA A 020A060	0,2 ... 7,5	0,3 0,5	0,5 ... 8	460	253549
MDR-F 8HG-S	MDR-F 8 HAA SBA A 020A060	0,2 ... 7,5	0,3 0,5	0,5 ... 8	460	253556
MDR-F 10H-S	MDR-F 10 HAA SAA A 040A050	0,3 ... 9,2	0,4 0,8	0,7 ... 10	460	253563
MDR-F 10HG-S	MDR-F 10 HAA SBA A 040A050	0,3 ... 9,2	0,4 0,8	0,7 ... 10	460	253570
MDR-F 16H-S	MDR-F 16 HAA SAA A 040A120	0,4 ... 15	0,6 1,0	1 ... 16	460	253587
MDR-F 16HG-S	MDR-F 16 HAA SBA A 040A120	0,4 ... 15	0,6 1,0	1 ... 16	460	253594
MDR-F 32H-S	MDR-F 32 HAA SAA A 100A200	0,8 ... 30	1,2 2,0	2 ... 32	460	253600
MDR-F 32HG-S	MDR-F 32 HAA SBA A 100A200	0,8 ... 30	1,2 2,0	2 ... 32	460	253617

* lower ... upper end of range
 ** G 1/4" + G 1/2" innerthread - on demand

MDR-F standard version with plastic flange



MDR-F standard version with plastic flange and Perbunan diaphragm - e.g. for demineralized water. Pressure switch with industrial cage clamp version.
 Pressure connection: Y G 3/8" inner thread ** - suffix "G" for gold-flashed contacts

Order reference	Type Code	Adjustable cut-in pressure (bar)	Smallest pressure diff. (bar)*	Adjustable cut-out pressure (bar)	Weight (in g)	Part No.
MDR-F 2Y-S	MDR-F 2 YAA SAA A 005A015	0,04 ... 1,89	0,07 0,11	0,11 ... 2	410	253624
MDR-F 2YG-S	MDR-F 2 YAA SBA A 005A015	0,04 ... 1,89	0,07 0,11	0,11 ... 2	410	253631
MDR-F 4Y-S	MDR-F 4 YAA SAA A 010A030	0,07 ... 3,75	0,15 0,25	0,22 ... 4	410	253648
MDR-F 4YG-S	MDR-F 4 YAA SBA A 010A030	0,07 ... 3,75	0,15 0,25	0,22 ... 4	410	253655
MDR-F 8Y-S	MDR-F 8 YAA SAA A 020A060	0,2 ... 7,5	0,3 0,5	0,5 ... 8	410	253662
MDR-F 8YG-S	MDR-F 8 YAA SBA A 020A060	0,2 ... 7,5	0,3 0,5	0,5 ... 8	410	253679
MDR-F 10Y-S	MDR-F 10 YAA SAA A 040A050	0,3 ... 9,2	0,4 0,8	0,7 ... 10	410	253686
MDR-F 10YG-S	MDR-F 10 YAA SBA A 040A050	0,3 ... 9,2	0,4 0,8	0,7 ... 10	410	253693
MDR-F 16Y-S	MDR-F 16 YAA SAA A 040A120	0,4 ... 15	0,6 1,0	1 ... 16	410	253709
MDR-F 16YG-S	MDR-F 16 YAA SBA A 040A120	0,4 ... 15	0,6 1,0	1 ... 16	410	253716

* lower ... upper end of range
 ** G 1/4" + G 1/2" innerthread - on demand

Control pressure switch MDR - F

MDR-F features Pressure connection and pressure transducer element stainless steel



MDR-F features Pressure connection and pressure transducer element
Stainless steel for liquid fuels, oils up to 200 ° C, etc..
Pressure switch equipped with industry-screw
Pressure connection: G 1/4 "female thread - suffix " G
"for gold-plated contacts."

Order reference	Type Code	Adjustable cut-in pressure (bar)	Smallest pressure diff. (bar)*	Adjustable cut-out pressure (bar)	Weight (in g)	Part No.
MDR-F 12HE-S	MDR-F 12 HEC SAA A 060A070	0,5 ... 11,2	0,5 0,8	1 ... 12	520	253723
MDR-F 12HEG-S	MDR-F 12 HEC SBA A 060A070	0,5 ... 11,2	0,5 0,8	1 ... 12	520	253730
MDR-F 30HE-S	MDR-F 30 HEC SAA A 160A200	1 ... 26,4	3,0 3,6	4 ... 30	520	253747
MDR-F 30HEG-S	MDR-F 30 HEC SBA A 160A200	1 ... 26,4	3,0 3,6	4 ... 30	520	253754

* lower ...upper end of range

Control pressure switches

MDR-F high-pressure switch version (up to 250 bar)



MDR-F high-pressure switch version (up to 250 bar)
with plastic plunger press. sensing element with stainless steel
connection and Industrial cage clamp version for oil, water and air
etc. .
Pressure connection: HH G 3/8" inner thread - suffix " G"
for gold-flashed contacts

Order reference	Type Code	Adjustable cut-in pressure (bar)	Smallest pressure diff. (bar)*	Adjustable cut-out pressure (bar)	Weight (in g)	Part No.
MDR-F 60HH-S	MDR-F 60 HHA SAA A 200A400	4 ... 52	4 8	8 ... 60	570	253761
MDR-F 60HHG-S	MDR-F 60 HHA SBA A 200A400	4 ... 52	4 8	8 ... 60	570	253778
MDR-F 120HH-S	MDR-F 120 HHA SAA A 200A800	8 ... 104	8 16	16 ... 120	570	253785
MDR-F 120HHG-S	MDR-F 120 HHA SBA A 200A800	8 ... 104	8 16	16 ... 120	570	253792
MDR-F 250HH-S	MDR-F 250 HHA SAA A 100B200	14 ... 226	12 24	26 ... 250	570	253808
MDR-F 250HHG-S	MDR-F 250 HHA SBA A 100B200	14 ... 226	12 24	26 ... 250	570	253815

* lower ...upper end of range

MDR-F version with reset function (Hmin / Hmax and Htro) with die-cast aluminium flange



MDR-F version with reset function (Hmin / Hmax and Htro) with die-cast aluminium flange and Perbunan diaphragm - for oil, water and air etc. Pressure switch with industrial cage clamp version. Pressure connection: H G 3/8" inner thread

MDR-F .. Hmax (SPDT with manual reset max.)

When pressure rises above the upper setting value, contact 11-12 opens and contact 11-14 closes and latches. When the pressure falls below the upper setting value, the contact can be released with the manual reset button.

MDR-F .. Hmin (SPDT with manual reset min.)

After pressure rises above the lower setting value, the function is activated by pressing the manual reset button. When the pressure falls, contact 11-12 closes and opens contact 11-14 when reaching the lower cut-in value. Since the upper switching point (cut-out pressure) of the reset pressure switch must lie above the maximum cut-out pressure of the apparatus, the switching state remains until the manual reset button is pressed again.

MDR-F .. Htro (SPDT with manual reset as run-dry protection)

Typically, the switch is connected in series with the control circuit. For pressure increase, the manual reset button must be held until the pressure lies beyond the monitoring point. When the pressure falls below the monitoring point, contact 11-12 closes and contact 11-14 opens. When the pressure automatically rises above 10% of the monitored pressure, contact 11-12 opens and contact 11-14 closes again automatically, otherwise, a restart using the manual reset button must be carried out again. NOTICE: Should there not be a rise in pressure when pressing the button, discontinue pressing the button as a fault in the system must be present.

Order reference	Type Code	Adjustable cut-in pressure (bar)	Smallest pressure diff. (bar)*	Adjustable cut-out pressure (bar)	Weight (in g)	Part No.
MDR-F 2Hmax-S	MDR-F 2 HAA SAH A XXXA015	-	-	0,11 ... 2	430	254065
MDR-F 4Hmax-S	MDR-F 4 HAA SAH A XXXA030	-	-	0,22 ... 4	430	254072
MDR-F 8Hmax-S	MDR-F 8 HAA SAH A XXXA060	-	-	0,5 ... 8	430	254089
MDR-F 10Hmax-S	MDR-F 10 HAA SAH A XXXA075	-	-	0,7 ... 10	430	254096
MDR-F 16Hmax-S	MDR-F 16 HAA SAH A XXXA120	-	-	1 ... 16	430	254102
MDR-F 32Hmax-S	MDR-F 32 HAA SAH A XXXA240	-	-	2 ... 32	430	254119
MDR-F 2Hmin-S *1	MDR-F 2 HAA SAL A 005A015	0,04 ... 1,89	0,07 0,11	0,11 ... 2	430	254126
MDR-F 4Hmin-S *1	MDR-F 4 HAA SAL A 010A030	0,07 ... 3,75	0,15 0,25	0,22 ... 4	430	254133
MDR-F 8Hmin-S *1	MDR-F 8 HAA SAL A 020A060	0,2 ... 7,5	0,3 0,5	0,5 ... 8	430	254140
MDR-F 10Hmin-S *1	MDR-F 10 HAA SAL A 025A075	0,3 ... 9,2	0,4 0,8	0,7 ... 10	430	254157
MDR-F 16Hmin-S *1	MDR-F 16 HAA SAL A 040A120	0,4 ... 15	0,6 1,0	1 ... 16	430	254164
MDR-F 32Hmin-S *1	MDR-F 32 HAA SAL A 080A240	0,8 ... 30	1,2 2,0	2 ... 32	430	254171
MDR-F 2Htro-S	MDR-F 2 HAA SAG A 005AXXX	0,04 ... 1,89	-	-	430	254188
MDR-F 4Htro-S	MDR-F 4 HAA SAG A 010AXXX	0,07 ... 3,75	-	-	430	254195
MDR-F 8Htro-S	MDR-F 8 HAA SAG A 020AXXX	0,2 ... 7,5	-	-	430	254201
MDR-F 10Htro-S	MDR-F 10 HAA SAG A 025AXXX	0,3 ... 9,2	-	-	430	254218
MDR-F 16Htro-S	MDR-F 16 HAA SAG A 040AXXX	0,4 ... 15	-	-	430	254225
MDR-F 32Htro-S	MDR-F 32 HAA SAG A 080AXXX	0,8 ... 30	-	-	430	254232

* lower ... upper end of range

*1 The minimum-pressure to be overseen and the operating-pressure must be in the pressure-spectrum of the cut-in-pressure.

Additional MDR-F pressure switch versions .. Reset function are available on request (e.g. as stainless steel bellows version, with gold-flashed contacts, as high pressure switch etc.).

MDR-F

LARGE NUMBER OF ALTERNATIVES &

UNIVERSAL APPLICATIONS



MDR-F version with die-cast aluminium flange and Viton diaphragm

for **enhanced media resistance**. Pressure switch with industrial cage clamp version.
Pressure connection: H G 3/8" inner thread

Order reference	Type Code	Adjustable cut-in pressure (bar)	Smallest pressure diff. (bar)*	Adjustable cut-out pressure (bar)	Weight (in g)	Part No.
MDR-F 2HV-S	MDR-F 2 HVA SAA A 005A015	0,04 ... 1,89	0,07 0,11	0,11 ... 2	410	253884
MDR-F 4HV-S	MDR-F 4 HVA SAA A 010A030	0,07 ... 3,75	0,15 0,25	0,22 ... 4	410	253891
MDR-F 8HV-S	MDR-F 8 HVA SAA A 020A060	0,2 ... 7,5	0,3 0,5	0,5 ... 8	410	253907
MDR-F10 HV-S	MDR-F 10 HVA SAA A 040A050	0,3 ... 9,2	0,4 0,8	0,7 ... 10	410	253914
MDR-F 16HV-S	MDR-F 16 HVA SAA A 040A120	0,4 ... 15	0,6 1,0	1 ... 16	410	253921
MDR-F 32HV-S	MDR-F 16 HVA SAA A 100A200	0,8 ... 30	1,2 2,0	2 ... 32	410	253938

* lower ... upper end of range

Additional MDR-F pressure switch versions MDR-F.HV are available on request (e. g. with reset function, with gold-flashed contacts, with plastic flange etc.)

VdS pressure switches for water extinguishing systems / fire-fighting equipments



These pressure switches are primarily conceived for the use in firmly installed water extinguishing systems / fire-fighting equipments and approved from the VdS damage-prevention under the NO. G 4090008.

In particular, selective examinations, the request-profiles, the quality and the functionality intensively are tested.

Dependent on the use there are:

- Alarm pressure switches (MDR-F 2...VdS...), which are manufactured with a pressure range from 0,35 to 1 bar with minimal difference, and
- Pressure switches (MDR-F X...VdS...), with 10, 12,5 or 16 bar set for X, which limit the maximum pressure



VdS pressure switches for water extinguishing systems / fire-fighting equipments

difference between cut-in and cut-out pressure to 1,5 bar.

As MDR-F...VdS with reset function, standard only the alarm pressure switch is as max.-Reset listed. However, it is all VdS pressure switch with each reset function (see overview MDR-F with reset function), alternatively a Viton diaphragm and / or also a flange with 3/8" inner-screw threads on inquiry available.

Moreover, customer-specific boards with own circuits and LED in integrated design are available as well as realisable. Further information can be seen on our homepage: www.condor-cpc.com.

Please take into account that the use of the pressure switch with plastic flange is restricted up to 10 bar.

MDR-F VdS version for water-based extinguishing systems / fire protection with die-cast aluminium flange

and Perbunan diaphragm for water extinguishing systems. Pressure switch with industrial cage clamp version.
Pressure connection: H G 1/2" inner thread

Order reference	Type Code	Adjustable cut-in pressure (bar)	Smallest pressure diff. (bar)*	Adjustable cut-out pressure (bar)	Weight (in g)	Part No.
MDR-F 2H-S VdS	MDR-F 2 HAB SAA A XXXA007 A		0,1	0,35 ... 1	460	259060
MDR-F 2Hmax-S VdS	MDR-F 2 HAB SAH A XXXA007 A		0,1	0,35 ... 1	460	259077
MDR-F 10H-S VdS	MDR-F 10 HAB SAA A 040A050 A	0,3 ... 8,5	0,4 1,5	0,7 ... 10	460	259084
MDR-F 12H-S VdS	MDR-F 12 HAB SAA A 080A090 A	0,4 ... 11	0,6 1,5	1 ... 12,5	460	259091
MDR-F 16H-S VdS	MDR-F 16 HAB SAA A 110A120 A	0,4 ... 14,5	0,6 1,5	1 ... 16	460	259107

MDR-F VdS overview for water-based extinguishing systems / fire protection MDR-F .. Y...with plastic flange

and Perbunan diaphragm for water extinguishing systems / fire-fighting equipments. Pressure switch with industrial cage clamp version.

Pressure connection: H G 1/2" inner thread

Order reference	Type Code	Adjustable cut-in pressure (bar)	Smallest pressure diff. (bar)*	Adjustable cut-out pressure (bar)	Weight (in g)	Part No.
MDR-F 2Y-S VdS	MDR-F 2 YAB SAA A XXXA007 A		0,1	0,35 ... 1	410	259145
MDR-F 2Ymax-S VdS	MDR-F 2 YAB SAH A XXXA007 A		0,1	0,35 ... 1	410	259152
MDR-F 10Y-S VdS	MDR-F 10 YAB SAA A 040A050 A	0,3 ... 8,5	0,4 1,5	0,7 ... 10	410	259169

Control pressure switch MDR - F

GL Pressure Switch for Ship Building and Applications Intended for Use at Sea



These pressure switches are mostly used in the field of shipping technology, particularly in ship and plant engineering, and are approved by GL (Germanischer Lloyd); one of the largest classification societies in the field of shipping, under No. 86884-10 HH.

The requirement profiles, quality and functionality have been intensively tested by means of specialized, demanding tests.

Our GL pressure switches can be used up to a maximum of 250 bar. Pressure switches fitted with plastic flanges are approved up to 12.5 bar.

All GL pressure switches can also be fitted with a reset button.

Because of the variety of possible pressure switch configurations, please feel free to simply contact us if you have queries regarding special applications or technical requests.



Condor Pressure Switch for ship Building and Applications Intended for Use at Sea are approved by GL (Germanischer Lloyd).

MDR-F GL version GL - MDR-F..H..GLf - with die-cast aluminium flange

and Perbunan diaphragm, GL cable gland, **for shipbuilding and seaworthy applications**. Pressure switch with industrial cage clamp version. Pressure connection: G 3/8" inner thread

Order reference	Type Code	Adjustable cut-in pressure (bar)	Smallest pressure diff. (bar)*	Adjustable cut-out pressure (bar)	Weight (in g)	Part No.
MDR-F 2H-S GL	MDR-F 2 HAA SAA H 005A015 G	0,04 ... 1,89	0,07 0,11	0,11 ... 2	540	261766
MDR-F 4H-S GL	MDR-F 4 HAA SAA H 010A030 G	0,07 ... 3,75	0,15 0,25	0,22 ... 4	540	261773
MDR-F 8H-S GL	MDR-F 8 HAA SAA H 020A060 G	0,2 ... 7,5	0,3 0,5	0,5 ... 8	540	261780
MDR-F 10H-S GL	MDR-F 10 HAA SAA H 040A050 G	0,3 ... 9,2	0,4 0,8	0,7 ... 10	540	261797
MDR-F 12H-S GL	MDR-F 12 HAA SAA H 080A090 G	0,4 ... 11	0,6 1,5	1 ... 12,5	540	261896
MDR-F 16H-S GL	MDR-F 16 HAA SAA H 040A120 G	0,4 ... 15	0,6 1,0	1 ... 16	540	261803
MDR-F 32H-S GL	MDR-F 32 HAA SAA H 100A200 G	0,8 ... 30	1,2 2,0	2 ... 32	540	261810

* lower ...upper end of range

MDR-F overview GL - MDR-F .. HH..GL - High pressure switch (up to 250 bar) with plastic plunger

sensing element with stainless steel connection, GL Cable gland, **for shipbuilding and seaworthy applications**. Pressure switch with industrial cage clamp version. Pressure Connection: HH G 3/8" inner thread

Order reference	Type Code	Adjustable cut-in pressure (bar)	Smallest pressure diff. (bar)*	Adjustable cut-out pressure (bar)	Weight (in g)	Part No.
MDR-F 60HH-S GL	MDR-F 60 HHA SAA H 200A400 G	4 ... 52 bar	4 8	8 ... 60 bar	570	261858
MDR-F 120HH-S GL	MDR-F 120 HHA SAA H 200A800 G	8 ... 104 bar	8 16	16 ... 120 bar	570	261865
MDR-F 250HH-S GL	MDR-F 250 HHA SAA H 100B200 G	14 ... 226 bar	12 24	26 ... 250 bar	570	261872

* lower ...upper end of range



You need more information? - Request our special catalog - "GL" -products!



Control pressure switch MDR - F

MDR-F UL version for the North American market



Pressure switches are designed for the North American market and were approved by Underwriters Laboratories, Inc. (UL) under the approval number E86689. During special high-demanding examinations, requirements, quality and functionality

were tested intensively. Due to the variety of possible pressure switch versions, please simply contact us for questions about special applications or technical requests.

MDR-F overview UL - MDR-F .. H...UL - Pressure switch with aluminium die-cast flange

and with NBR diaphragm. Pressure switch with industrial cage clamp version.
Pressure connection: G 3/8" inner thread*)

Order reference	Type Code	Adjustable cut-in pressure (bar)	Smallest pressure diff. (psi)	Adjustable cut-out pressure (psi)	Weight (in g)	Part No.
MDR-F 2H-S UL	MDR-F 2 HAA SAA A 008D020 EXXX ---1pce.a	0,6...27	1 2	1,6...29	460	269885
MDR-F 4H-S UL	MDR-F 4 HAA SAA A 015D040 EXXX ---1pce.a	1...54	2 4	3...58	460	269892
MDR-F 8H-S UL	MDR-F 8 HAA SAA A 030D060 EXXX ---1pce.a	3...108	4 8	7...116	460	269908
MDR-F 10H-S UL	MDR-F 10 HAA SAA A 060D075 EXXX ---1pce.a	4...133	6 12	10...145	460	269915
MDR-F 16H-S UL	MDR-F 16 HAA SAA A 080D160 EXXX ---1pce.a	6...217	9 15	15...232	460	269922
MDR-F 32H-S UL	MDR-F 32 HAA SAA A 145D290 EXXX ---1pce.a	12...435	18 29	30...464	460	269939

*) 1/4"NPT on request

MDR-F overview UL - MDR-F .. HH...UL - High pressure switch (up to 3625 psi) with plastic plunger

with stainless steel and aluminium die-cast flange. Pressure switch with industrial cage clamp version.
Pressure connection: G 3/8" inner thread with choke

Order reference	Type Code	Adjustable cut-in pressure (bar)	Smallest pressure diff. (psi)	Adjustable cut-out pressure (psi)	Weight (in g)	Part No.
MDR-F 60HH-S UL	MDR-F 60 HHA SAA A 290D580 EXXX ---1pce.a	58...754	58 116	116...870	570	269946
MDR-F 120HH-S UL	MDR-F 120 HHA SAA A 058E116 EXXX ---1pce.a	116...1508	116 232	232...1740	570	269953
MDR-F 250HH-S UL	MDR-F 250 HHA SAA A 145E290 EXXX ---1pce.a	203...3277	174 348	377...3625	570	269960

MDR-F overview UL - MDR-F .. H...UL - for monitoring vacuum with aluminium die-cast flange

and with NBR diaphragm. Pressure switch with industrial cage clamp version.
Pressure connection: G 1/4" inner thread

Order reference	Type Code	Adjustable cut-in pressure (bar)	Smallest pressure diff. (psi)	Adjustable cut-out pressure (psi)	Weight (in g)	Part No.
MDR-F 03H-S UL	MDR-F 03 HAC SAA A 010V030 EXXX ---1pce.a	-13 ... 2,2	2,2	-10,9...4,4	508	269977
MDR-F 3H-S UL	MDR-F 3 HAC SAA A 100V150 EXXX ---1pce.a	-13 ... 37,7	2,9 5,8	-10,2...43,5	522	269984

Control pressure switch MDR - F

MDR-F vacuum monitoring version

These pressure switches can be used as vacuum switches for compressible materials (gases), but also for liquids, within the normal pressure range.

Their range of application includes, for example, the fields of automation, transportation, heating, climate-control and ventilation.

They have been designed primarily for use in the rough vacuum range (technical vacuum) and are distinguished by their small pressure differences and high level of switching precision.

They offer universal application potential as openers, closers or changers.

MDR-F overview - MDR-F .. H (G) - for Vacuum monitoring with aluminium die-cast flange

and with Perbunan diaphragm - for oil, water and air etc. . Pressure switch with industrial cage clamp version.
Pressure connection: H G 1/4" inner thread - suffix "G" for gold-flashed contacts

Order reference	Type Code	Adjustable cut-in pressure (bar)	Smallest pressure diff. (bar)*	Adjustable cut-out pressure (bar)	Weight (in g)	Part No.
MDR-F 03H-S	MDR-F 03 HAC SAA A 010V030 XXXX	-0,9 ... 0,15	0.15	-0.75 ... 0.3	508	264019
MDR-F 03HG-S	MDR-F 03 HAC SBA A 010V030 XXXX	-0,9 ... 0,15	0.15	-0.75 ... 0.3	508	264026
MDR-F 3H-S	MDR-F 3 HAC SAA A 100V150 XXXX	-0,9 ... 2.6	0.2 0.4	-0,7 ... 3	522	264057
MDR-F 3HG-S	MDR-F 3 HAC SBA A 100V150 XXXX	-0,9 ... 2.6	0.2 0.4	-0,7 ... 3	522	264064

MDR-F DPDT version

This pressure switch is characterized by being equipped with a DPDT. As a result, the switch is even more flexible in its range of applications. Due to the variety of possible

pressure switch versions, please simply contact us for questions about special applications or technical requests.

MDR-F overview - MDR-F .. H...LF - with aluminium die-cast flange

and with NBR diaphragm - for oil, water and air etc. . Pressure switch with industrial cage clamp version.
Pressure connection: G 3/8" inner thread

Order reference	Type Code	Adjustable cut-in pressure (bar)	Smallest pressure diff. (bar)*	Adjustable cut-out pressure (bar)	Weight (in g)	Part No.
MDR-F 2H-2W-S	MDR-F 2 HAA LFA D 005A015 XXXX ---1pce.a	0.04 ... 1.84	0.08 ... 0.16	0.12 ... 2	460	269717
MDR-F 4H-2W-S	MDR-F 4 HAA LFA D 010A030 XXXX ---1pce.a	0.07 ... 3.65	0.18 0.35	0.25 ... 4	460	269724
MDR-F 8H-2W-S	MDR-F 8 HAA LFA D 020A060 XXXX ---1pce.a	0.2 ... 7.3	0.35 0.7	0.55 ... 8	460	269731
MDR-F 10H-2W-S	MDR-F 10 HAA LFA D 040A050 XXXX ---1pce.a	0.3 ... 8.9	0.45 1.1	0.75 ... 10	460	269748
MDR-F 16H-2W-S	MDR-F 16 HAA LFA D 040A120 XXXX ---1pce.a	0.4 ... 14.6	0.7 1,4	1.1 ... 16	460	269755
MDR-F 32H-2W-S	MDR-F 32 HAA LFA D 100A200 XXXX ---1pce.a	0.8 ... 29.2	1.4 2.8	2.2 ... 32	460	269762

MDR-F Type overview - MDR-F .. H...LF - with plastic flange

and with NBR diaphragm - for example, for purified water. Pressure switch with industrial cage clamp version.
Pressure connection: G 3/8" inner thread

Order reference	Type Code	Adjustable cut-in pressure (bar)	Smallest pressure diff. (bar)*	Adjustable cut-out pressure (bar)	Weight (in g)	Part No.
MDR-F 2Y-2W-S	MDR-F 2 YAA LFA D 005A015 XXXX ---1pce.a	0.04 ... 1.84	0.08 0.16	0.12 ... 2	410	269779
MDR-F 4Y-2W-S	MDR-F 4 YAA LFA D 010A030 XXXX ---1pce.a	0.07 ... 3.65	0.18 0.35	0.25 ... 4	410	269786
MDR-F 8Y-2W-S	MDR-F 8 YAA LFA D 020A060 XXXX ---1pce.a	0.2 ... 7.3	0.35 0.7	0.55 ... 8	410	269793
MDR-F 10Y-2W-S	MDR-F 10 YAA LFA D 040A050 XXXX ---1pce.a	0.3 ... 8.9	0.45 1.1	0.75 ... 10	410	269709
MDR-F 16Y-2W-S	MDR-F 16 YAA LFA D 040A120 XXXX ---1pce.a	0.4 ... 14.6	0.7 1,4	1.1 ... 16	410	269716



Control pressure switch MDR - F

Technical data MDR-F standard version	
Rated operational current I_e AC 1 $U_e=240\text{ V (1~)}$	10 A
Rated operational current I_e AC 15 $U_e=240\text{ V (1~)}$	4 A
Rated operational current I_e DC 13 $U_e=240\text{ V (1~)}$	0,1 A
Permissible motor rating 1~ 230 V	0,55 kW
Motor switching capacity (UL 508, CSA 22.2) $U_e=125\text{ VAC}$	0,5 HP
Motor switching capacity (UL 508, CSA 22.2) $U_e=250\text{ VAC}$	0,5 HP
Rated operational current I_e (UL 508, CSA 22.2) $U_e=250\text{ VAC}$	15 A
Rated operational current I_e (UL 508, CSA 22.2) $U_e=12\text{ VDC}$	6 A

Technical data MDR-F... Ex	
Maximum switching voltage U_i	200 V
Maximum switching strength I_i	3 A
Maximum internal capacity C_i	negligible
Maximum internal conductivity I_i	negligible
Ambient temperature T_a	$-30\text{ °C} \leq T_a \leq +65\text{ °C}$
Only for connection to a separately examined and certified intrinsically safe circuit in the protection type: Ex ia I Mb (MDR-F... JG... Ex) Ex ia IIC Ex ia IIA, IIB, IIC T6 Gb (MDR-F ... HG...Ex) Ex ia IIIC T85°C Db (MDR-F ... HG...Ex)	

Technical data MDR-F.(G) - gold-flashed contact	
Rated operational current I_e $U_e=30\text{ V (1~)}$	400 mA
Permissible motor rating 1~ 30 V	12 VA
Motor switching capacity (UL 508, CSA 22.2) $U_e=125 - 250\text{ VAC}$	0,5 HP
Rated operational current I_e (UL 508, CSA 22.2) $U_e=250\text{ VAC}$	10 A
Rated operational current I_e (UL 508, CSA 22.2) $U_e=12\text{ VDC}$	6 A

Technical data MDR-F		
Bursting strength / bar	MDR-F.H	4 x max. cut-out pressure
	MDR-F.HE	1,3 x max. cut-out pressure
	MDR-F.Y ($\leq 12,5\text{ bar}$)	4 x max. cut-out pressure
	MDR-F.Y ($> 12,5\text{ bar}$)	2,5 x max. cut-out pressure

Technical data MDR-F	
Vibration resistance 10 bis 1000 Hz	4 g
Degree of protection acc. to DIN 40 050/IEC 529 With rubber grommets	IP 54
Degree of protection acc. to DIN 40 050/IEC 529 With cable glands M20	IP 65
Ambient temperature range	$-20\text{ °C} \dots +70\text{ °C}$
Cross-sections Cage clamp (without cable end sleeve)	1,5 mm ²
Cross-sections Screw clamp	2,5 mm ²

Technical data MDR-F		
Perm. media temperature:	MDR-F.H / HH	+ 70 °C
	MDR-F.HV	+ 130 °C
	MDR-F.HE	+ 200 °C
	MDR-F.Y	+ 50 °C
Repeatability	<2% FS	

Attention: Please, regard the MDR-F instructions enclosing the pressure switch for the max. operating pressure and the max. inspection pressure.

Media resistance MDR-F.
A detailed overview of diaphragm media resistance for all pressure switches can be found on page 22. Please read the information carefully

Control pressure switch MDR - F

Dimensions MDR - F / Circuit diagram MDR-F

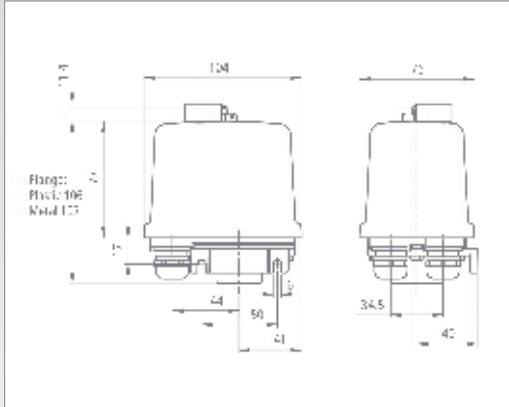

Pressure switch MDR – F.H / ..Y / ..HV

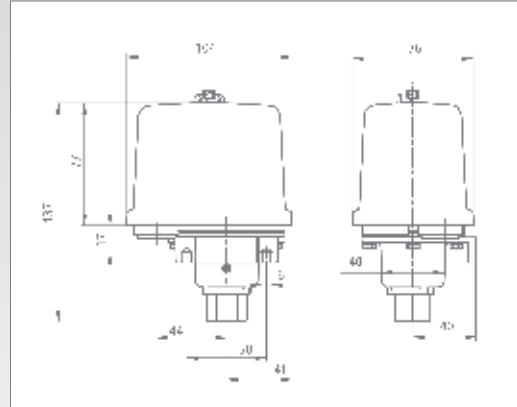

Pressure switch MDR – F.. HH / ..HE

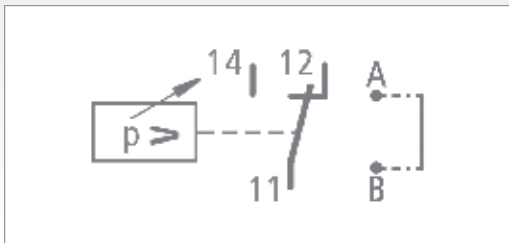

Accessories

Order reference	Description	Weight (in g)	Part No.
Cable glands			
MDR-F M20 M	Cable gland M20 metal	35	254249
MDR-F M20 K	Cable gland M20 plastic	18	259503
Throttle			
MDR-F D-32	MDR-F up to 32 bar	1	254256
MDR-F D+32	MDR-F as of 32 bar	2	254263
Covers			
MDR-F Cover	MDR-F Cover, transparent, Standard	90	254270
MDR-F Cover R	MDR-F Cover, transparent, with Reset push-button - for manual reset	115	254287
MDR-F Cover Alu	MDR-F Cover, Aluminium	252	265436
Reset push-button			
MDR-F RT-1	Reset push-buttons for mounting on cover R	25	254294

Additional accessories (e.g. pressure connectors) on demand

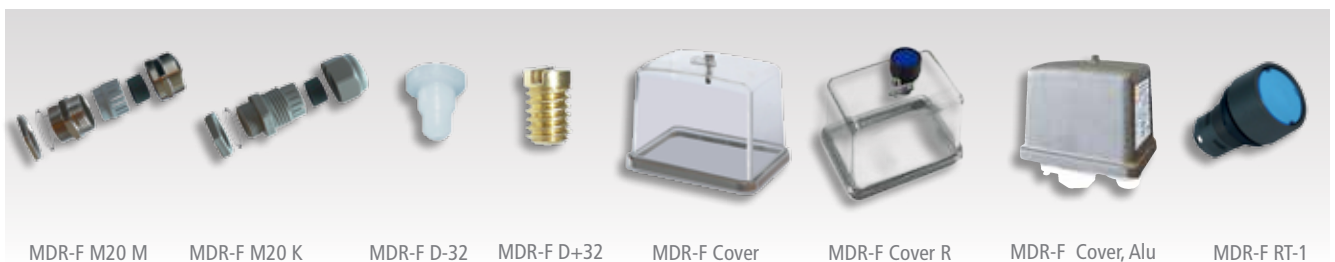

MDR-F M20 M

MDR-F M20 K

MDR-F D-32

MDR-F D+32

MDR-F Cover

MDR-F Cover R

MDR-F Cover, Alu

MDR-F RT-1

Pressure diagrams MDR-F

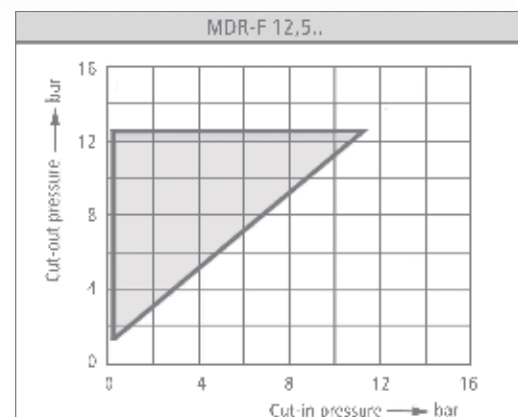
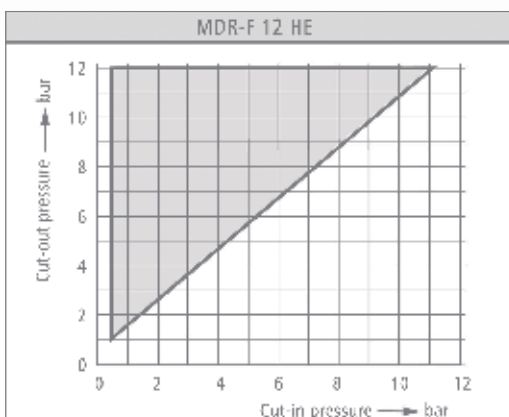
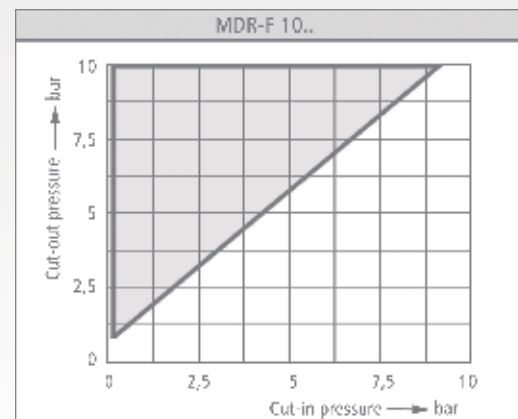
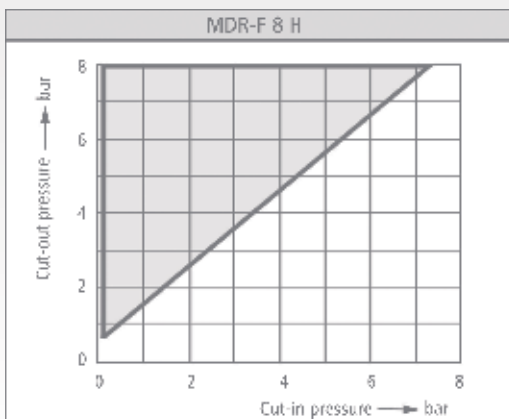
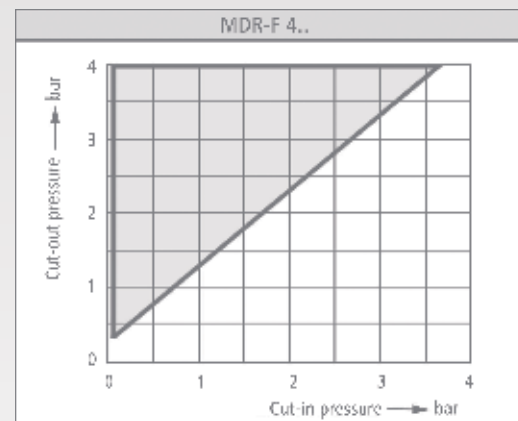
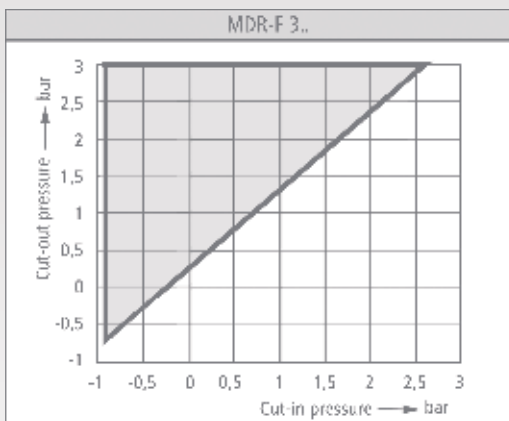
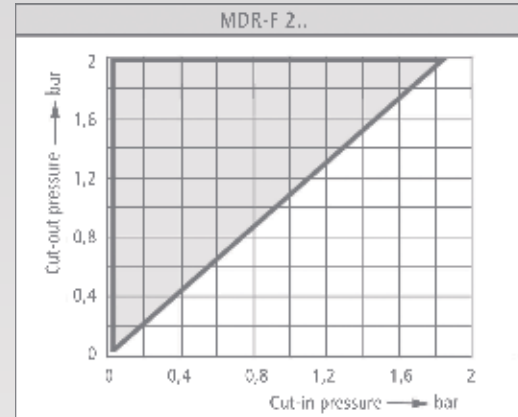
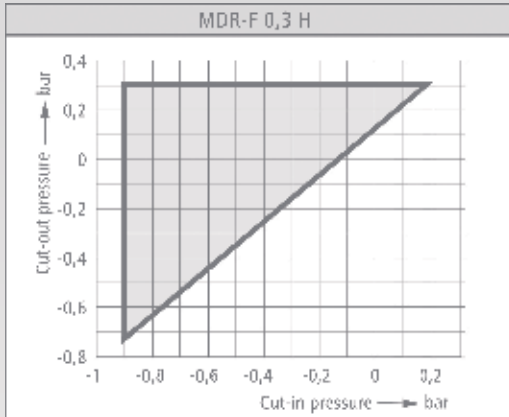

Pressure diagrams MDR-F

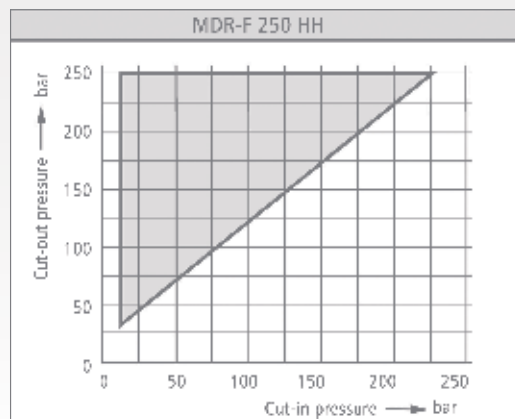
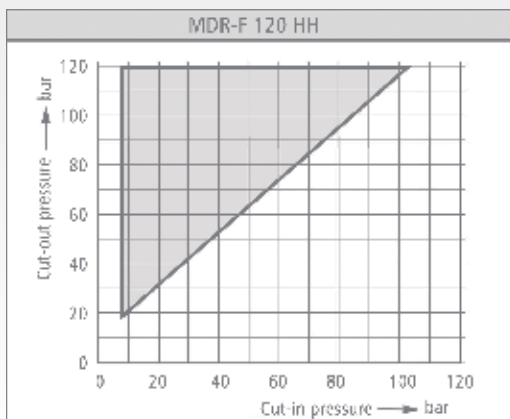
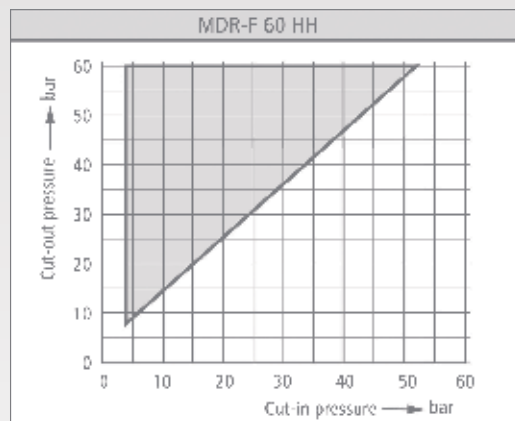
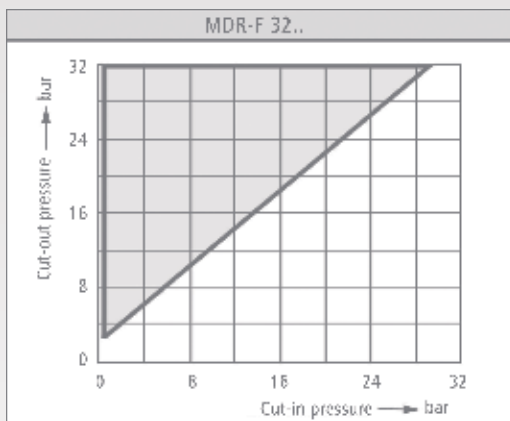
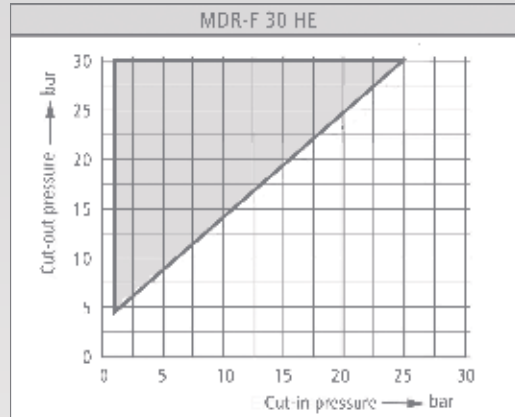
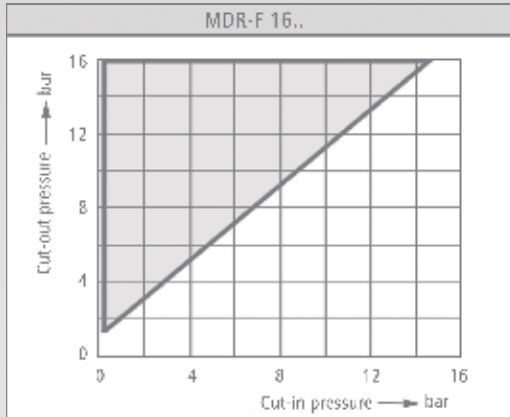

Note: All pressure diagrams do not apply to the "DPDT" version and not for "NO / NC". If needed, upon request.