



 **EVO**  
Line Chrome

## ELCH 300

Product code:  
Chrome: 13700140  
Gold: 13700110

## ELCH 450

Product code:  
Chrome: 13700141  
Gold: 13700111

## ELCH 550

Product code:  
Chrome: 13700142  
Gold: 13700112

## ELCH 650

Product code:  
Chrome: 13700143  
Gold: 13700113

## ELCH 750

Product code:  
Chrome: 13700144  
Gold: 13700114

## ELCH 850

Product code:  
Chrome: 13700145  
Gold: 13700115

## ELCH 950

Product code:  
Chrome: 13700146  
Gold: 13700116

## ELCH 1050

Product code:  
Chrome: 13700147  
Gold: 13700117

## ELCH 1150

Product code:  
Chrome: 13700148  
Gold: 13700118

## EVO Line Chrome

EVO LINE Chrome is available in 300mm, 450mm, 550mm, 650mm, 750mm, 850mm, 950mm, 1050mm 1150mm sizes with perfect final touch 2 in 1 grid made from AISI 304 stainless steel and K3 load class. In this model you can chose 2 different base, depending are you gonna use it in renovation projects or in new building. Model with Ultra Low S base have 62mm installation heigh, 25mm water seal and DN 50 mm horizontal outlet and it is used mainly for renovation projects. Model with Standard base have 125mm installation height, 50mm water seal and DN 50 mm horizontal outlet and it is in accordance with EN 1253 and recomended to use in new building projects. Model consist "All you need set" so client have in box everything needed for the installation and it is available also with 24k gold finish grid.



## EVO Line Chrome parts & specs



### RENOVATION

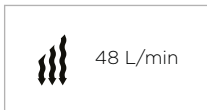
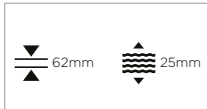

### NEW BUILDING

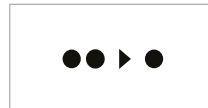
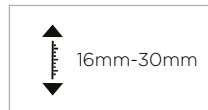
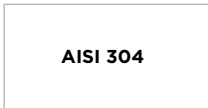
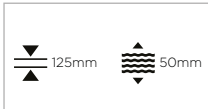

### Variants of grid finishing:

Brushed Chrome  
24k Gold plated

### LEGEND:

1. Height adjustment legs
2. Ultra low S Base
3. Reducer with rubber ring
4. Holder of grid
5. Grid for hair
6. Bridges for leveling of ceramic
7. Chrome



## EVO Line Chrome main advantages

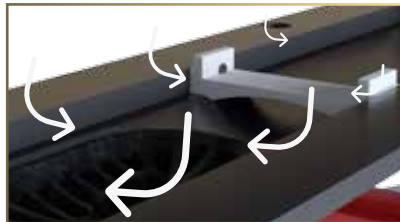

### Anti Leaking System

Thanks to new design of holder of grid, all condensed and leaked water under the tile finds its way back to the drain. In complete with self - adhesive butyl tape who comes with product represent Anti Leak System.



### Leveling of ceramic

Model have system for grid leveling so client can have flexibility in choosing surface in bathroom. Adjusting is performed by tightening and loosening of leveling screws in grid carrier. Grid can be leveled from 16mm up to 30mm of distance between holder of grid and top of the grid.



### Adjustment of drain height and base position

Universal solution for adjustment of installation height of drain and possibility of rotation of base for 360 degrees.

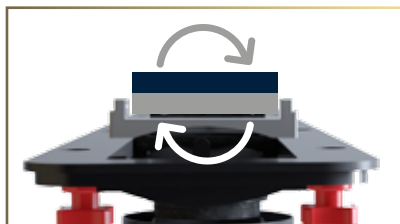

### 2 in 1 System

Grid of drain can be turned and used both for stainless steel and ceramic finish.



### 5 cm water seal set

As all of the Evolution shower drains are modular, client can with changing Ultra low S base with this 2 parts adjust all of our EVOLUTION LINE models to have 5 cm of water seal and in that way to be in accordance with EN 1253. Benefits of this model are: 15° rotatable adapter on base, Adapter on base is made from ABS so it can be connected both with push fit and solvent cement piping systems, product is in accordance with EN 1253 and this makes it perfect for new buildings projects, siphon can be cleaned very easily with simple pulling out of the cover of siphon.



## EVO Line Glass Black Techincal

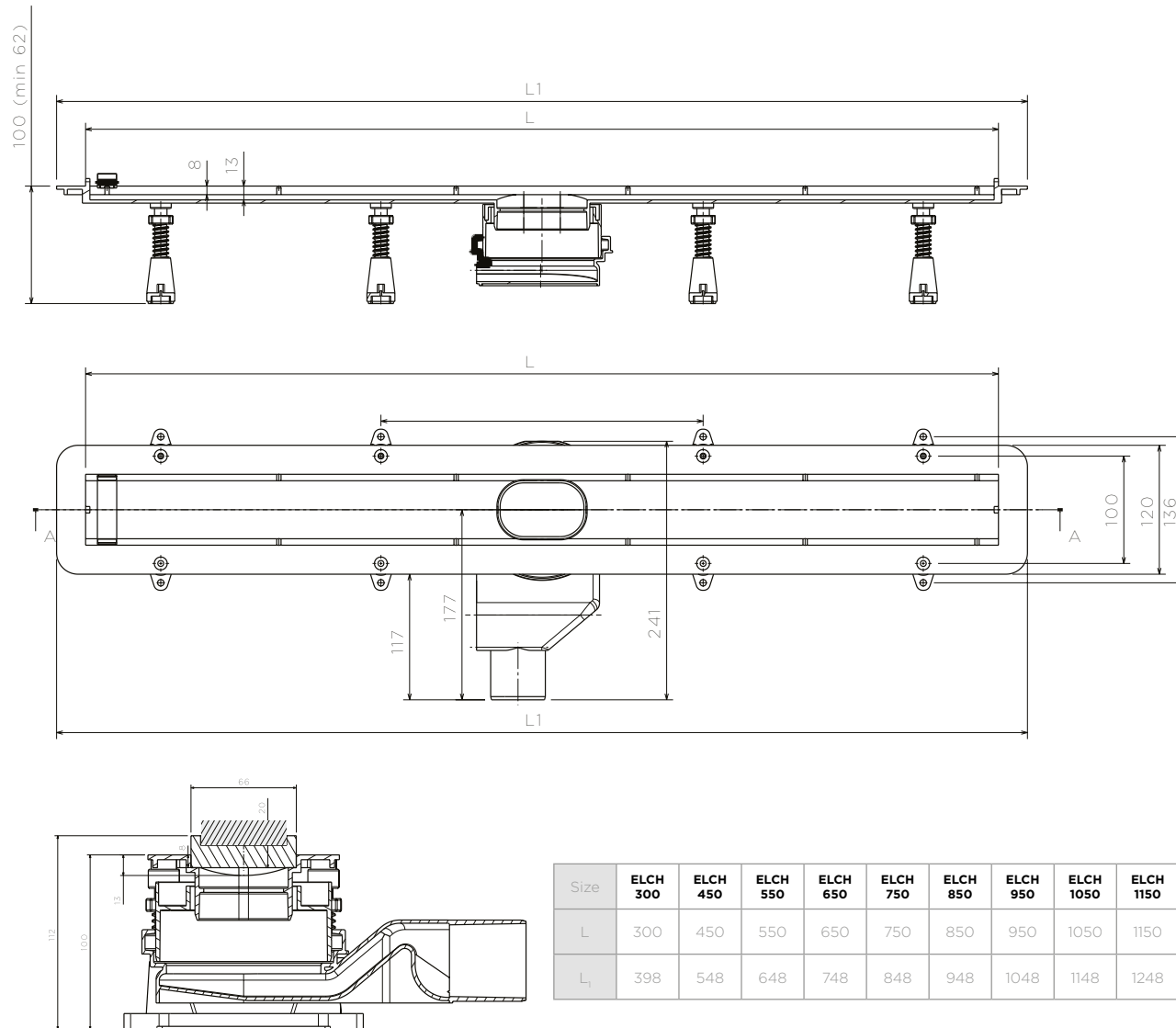

Size	ELCH 300	ELCH 450	ELCH 550	ELCH 650	ELCH 750	ELCH 850	ELCH 950	ELCH 1050	ELCH 1150
L	300	450	550	650	750	850	950	1050	1150
L <sub>1</sub>	398	548	648	748	848	948	1048	1148	1248

Thanks to new design of holder of grid, all condensed and leaked water under the tile finds it way back to the drain. In complete with self - adhesive butyl tape comes with product and makes Anti Leaking System.

Uniquesolutionforlevelingofgridofdrain in dependence of thickness of chosen ceramic by choosing different bridges for leveling. From 16mm up to 30mm.

Universal solution for adjustment of installation height of drain and possibility of rotation of base for 360 degrees. Thanks to universal solution for adjustment height of drain (DN 110mm cuttable reducer) EVO LINE shower drain have possibility of installation in both renovation and new building bathroom projects. Minimum installation height is 77mm and maximum is 110mm which fulfills all requests of modern buildings. Heigh adjustment legs enables extra security during instalation and use.

EVO LINE shower drain is manufactured in different sizes and is designed to satisfy most demanding customers regarding of their length. In dependence of your needs we offer following sizes: 650mm, 750mm, 850mm, 950mm and 1050mm.