

Standard Roof-top 1/4 compressors

Application program for pCO¹, pCO³, pCO^{XS}

CAREL



ENG

User manual

Manual version: 2.6 of 24/02/09

Program code: FLSTDMRT0E

→ **LEGGI E CONSERVA
QUESTE ISTRUZIONI** ←
→ **READ AND SAVE
THESE INSTRUCTIONS** ←

T e c h n o l o g y & E v o l u t i o n

CONTENTS

1. Introduction.....	5
1.1 Main new features in version 2.0.....	5
1.2 Main new features in version 2.1.....	5
1.3 Main new features in version 2.2.....	5
1.4 Main new features in version 2.3.....	5
1.5 Main new features in version 2.4.....	5
1.6 Main new features in version 2.5.....	5
1.7 Main new features in version 2.6.....	5
1.8 Introduction and functions performed by the program.....	6
1.9 Compatible hardware.....	6
2. The user terminal.....	7
2.1 Type and operation.....	7
2.2 LEDs.....	7
2.3 Functions of the buttons.....	8
3. pLAN management between boards	10
3.1 How to assign the pLAN addresses.....	10
4. Selecting the language.....	11
5. Starting for the first time	11
6. List of configurations	11
6.1 Digital inputs.....	11
6.2 Analogue inputs	12
6.3 Digital outputs.....	12
6.4 Analogue outputs.....	12
7. List of parameters	13
8. Screens.....	25
9. EVD400 electronic expansion valve	26
9.1 Configuring the EVD400.....	26
10. Ambient air temperature control	27
10.1 Cooling/Heating changeover.....	27
10.2 Unit ON/OFF	27
10.3 Compressor control.....	28
10.4 Load steps.....	28
10.5 Defrost	30
10.6 Reversing solenoid valves.....	32
10.7 Main fan	32
10.8 Condenser fans.....	32
10.9 Freecooling control and freeheating by temperature.....	34
10.10 Heating valve control.....	36
10.11 Outlet temperature limit.....	37
10.12 Heaters control	38
10.13 Notes on the relationship between the offset and differential settings for the heating devices and their activation sequence	39
10.14 Set point compensation.....	40
10.15 Heat recovery	41
10.16 Dehumidification	47
10.17 Post-heating during dehumidification.....	48
10.18 Humidification	49
10.19 Freecooling and freeheating control by enthalpy.....	49
11. Alarm management	51
11.1 Low pressure alarm circuit 1/2 in cooling/heating.....	52
11.2 Cooling set point less than heating set point alarm.....	52
11.3 Alarm log.....	52
11.4 SMS on alarm.....	52

12.	Service	53
12.1	Compressor and unit hour counter settings.....	53
12.2	Probe calibration.....	53
12.3	Test Inputs/Outputs.....	53
13.	Time bands	54
13.1	Weekly time bands	54
13.2	Daily time bands	54
14.	Supervisor variables	55
14.1	Digital variables.....	57
14.2	Analogue variables	4
14.3	Integer variables	59

1. Introduction

1.1 Main new features in version 2.0

New functions:

1. Implementation of compatibility with pCO³;
2. implementation of management of up to 4 compressors and 2 circuits;
3. implementation of EVD400 management;
4. implementation of heat recovery unit management;
5. implementation of humidification management with analogue output (pCO³);
6. antifreeze control with the unit off;
7. air quality control (CO₂) and ambient cleaning;
8. implementation of Spanish language.

1.2 Main new features in version 2.1

New functions:

1. Post-heating during dehumidification management

Bug fixed:

1. With display 15 keys it was not possible to go into EVD menu
2. Check the BMS database: delete some double variable, fix a problem on the summer-winter change. The data base is still compatible with old version
3. Improve the temperature limit management during dehumidification

1.3 Main new features in version 2.2

This version is only for internal use

1.4 Main new features in version 2.3

New functions:

1. Summer heating management

Bug fixed:

1. Update macroblock to manage the EVD400 to manage pressure gas bigger than 32.0bar, in order to have a right gas conversion pressure-temperature / temperature-pressure
2. With pCO₃ medium it was not possible to manage the condenser pressure/temperature of circuit 2
3. Improve the flow and filter management in case of the main fan is switched off by scheduler: in this case when the fan was off, then the flow and filter alarm can happen the same
4. In case of the main fan is switched off by scheduler, the delay time off fan was not respected

1.5 Main new features in version 2.4

Bug Fixed:

1. Fixed the freecooling setpoint: it didn't change if time band changed

1.6 Main new features in version 2.5

Bug Fixed:

1. Fixed management in analog outputs Y3 e Y4 in coupled fan mode: added a check in active compressors to manage the fan rotation

1.7 Main new features in version 2.6

Bug Fixed:

1. Fixed management of analog outputs Y3 and Y4 in case of compressor thermal overload (It has been also updated Alarm table, please refer to paragraph 11)
2. Updated macroblock for EVD400 driver
3. Improved defrost management
4. Modified the software in outlet temperature limit regulation, in accordance to the management in paragraph 10.11

1.8 Introduction and functions performed by the program

The "Standard Roof-top" program can be used with CAREL pCO¹ medium, pCO^{3S} or pCO³ Medium and Large boards; it manages the operation of Roof-top air-conditioning units.

The main functions of the program are:

- freecooling in cooling;
- freecooling in winter;
- freeheating;
- management of 1 or 2 electric heaters;
- humidity management;
- minimum and maximum outlet temperature control;
- alarm management, alarm log, device times, signals;
- complete management of the device times;
- connection with local supervision networks and BMS (LonWorks, BACnet, Modbus...);
- management of CO₂ probe for air quality control;
- management of heat recovery units (cross-flow, rotary, double coil);
- management of the antifreeze function with the unit off.

The user terminal is used to display and modify the following data at any time:

- readings of the probes connected and calibration;
- unit on and off;
- alarm detection;
- programming of the configuration parameters and the operating parameters with password-protected access;
- operating hours of the controlled devices and time bands with password-protected access;
- setting of the clock and the time bands with password-protected access;
- selection between the different languages available (English, Italian and Spanish).

The pLAN network connection of the pCO boards allows the following functions to be performed:

- control of up to 8 air-conditioners with just one external terminal.

WARNING: to avoid tampering during the operation, only qualified personnel must know the password.

1.9 Compatible hardware

The program is compatible with the following devices:

- pCO^{3S};
- pCO³ Medium and Large;
- pCO¹ medium;
- semi-graphic display PGD0*;
- built-in display on pCO³ board

2. The user terminal

2.1 Type and operation

Two types of terminal are envisaged:

1. PGD0/semi-graphic/6 buttons/4 rows - 20 columns/connection with telephone cable
2. Built-in/6 buttons/4 rows - 20 columns (pCO³ board only)/display on board

The user terminal can be used to perform all the operations allowed by the application program installed.

The user terminal displays the operating conditions of the unit at all times

The terminal can also be used to set all the unit operating parameters in real time.

It can be disconnected from the main board, and in fact is not required for operation.

2.2 LEDs

2.2.1 PGD0 terminal with 6 buttons

LED	Colour	Description
 button (Alarm)	Red	On – One or more active alarm conditions
PRG button	Yellow	On – Displaying/modifying the operating parameters

All the LEDs not described and located underneath the remaining 4 buttons indicate the correct power supply to the instrument. Together with the backlighting on the display, these will be switched off if no button is pressed on the keypad for 5 minutes.

2.2.2 PGD0 terminal with 15 buttons

Each button has a green LED indicating the specific group of parameters selected during the operations to display/modify the operating parameters.

The silicone rubber buttons have three different coloured LEDs, whose meaning is specified in the following table:

LED	Colour	Description
[On/Off] button	Green	On – Unit on Flashing – Unit off from supervisor or digital input
[Alarm] button	Red	On – One or more active alarm conditions
[Enter] button	Yellow	On – Instrument correctly powered

2.2.3 Built-In terminal with 6 buttons

Given the number of buttons and LEDs available, these have general meanings, as described below:

LED	Colour	Description
 button (Alarm)	Red	On – One or more active alarm conditions
[↵] button (Enter)	Yellow	On – Unit on Flashing – Unit off from supervisor or digital input
[Prg] button	Green	On – Displaying/modifying the operating parameters
[Esc] button	Green	On – Main menu parameters displayed

2.3 Functions of the buttons

2.3.1 PGD0 terminal with 6 buttons

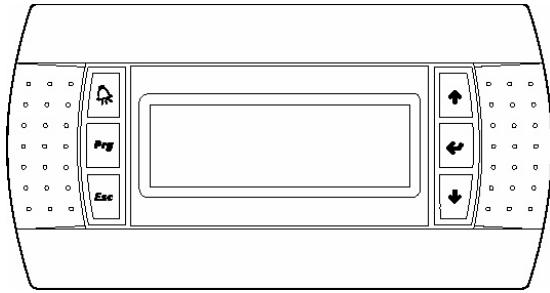













ALARM	UP
PRG	ENTER
ESC	DOWN

Button	Description
ALARM	displays the alarms, mutes the buzzer and deletes the active alarms
UP	if the cursor is in the home position (top left corner), scrolls up the screens in the same group; if the cursor is in a setting field, increases the value
DOWN	if the cursor is in the home position (top left corner), scrolls down the screens in the same group; if the cursor is in a setting field, decreases the value
ENTER	used to move the cursor from the home position (top left corner) to the setting fields, in the setting fields confirms the set value and moves to the next parameter
PRG	accesses the menu for selecting the group of parameters to be displayed/modified (access to the parameters is confirmed by pressing the [Enter] button)
PRG + ENTER	temporarily display the pLAN serial address of the board

2.3.2 PGD0 terminal with 15 buttons



Button	Description
 MENU	From any point of the user interface (with the exception of the manufacturer group of parameters) returns to the Main menu screen (M0) displaying the unit status, readings of the control probes and operating mode. In the group of manufacturer parameters, organised into nested sub-groups, returns to screen for selecting the parameters.
 SERVICE	Goes to the first screen of Service parameters (A0) The Service parameters are used to check the operating status of devices and the probes, calibrate the readings and run manual operations
 PRINTER	Goes to the printer menu (H1)
 INPUTS AND OUTPUTS	Goes to the first screen of I/O parameters (I0) The I/O parameters display the status of the inputs and the outputs on the board
 CLOCK	Goes to the first screen of Clock parameters (K0) The Clock parameters are used to display/set the operating parameters for the clock board and activate the time bands
 SET POINT	Goes to the first screen of Set point parameters (S0). The Set point parameters are used to display/modify the unit working set point within the limits defined in the configuration
 PROGRAM	Goes to the screen for entering the user password (P0) The user parameters are used to modify the unit operating mode
 MENU+PROG	Goes to the screen for entering the manufacturer password (Z0) The manufacturer parameters are used to configure the unit in terms of the number and type of devices connected, enable specific accessories or special functions

Button	Description	
		
	INFO	In pLAN applications with more than one board connected in the network and a shared user terminal, switches the user terminal between the different units to display/modify the parameters
	RED	Temporary display of the pLAN address of the current board
	BLUE	From printer management screen H1, starts printing screens C0 to Ca

Silicone rubber buttons



2.3.3 Built-In terminal with 6 buttons



ALARM	PRG	ESC
DOWN	UP	ENTER

Button	Description
ALARM	displays the alarms, mutes the buzzer and deletes the active alarms
UP	if the cursor is in the home position (top left corner), scrolls up the screens in the same group; if the cursor is in a setting field, increases the value
DOWN	if the cursor is in the home position (top left corner), scrolls down the screens in the same group; if the cursor is in a setting field, decreases the value
ENTER	used to move the cursor from the home position (top left corner) to the setting fields, in the setting fields confirms the set value and moves to the next parameter
PRG	accesses the menu for selecting the group of parameters to be displayed/modified (access to the parameters is confirmed by pressing the [Enter] button)
PRG + ENTER	temporary display of the board pLAN serial address

3. pLAN management between boards

The pLAN network identifies a physical connection between the boards (pCO1, pCO2, pCO3) and the external terminals. pLAN=p.CO Local Area Network.

The purpose of the pLAN network connection between the boards is to exchange variables, according to the logic decided by the program, so as the units can operate together. The variables exchanged between the boards are established by the program, as is the direction of exchange, and therefore there are no user settings; the only operation required by the user involves the electrical connections.

Below is a diagram with all the components connected in the pLAN:

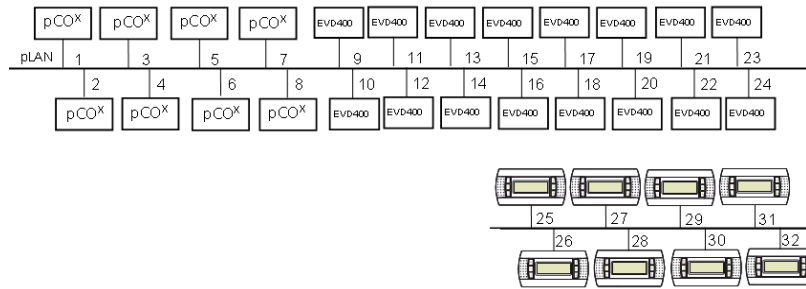

Below is a diagram with the EVD400 driver in a tLAN connection, while the others components are connected in the pLAN:

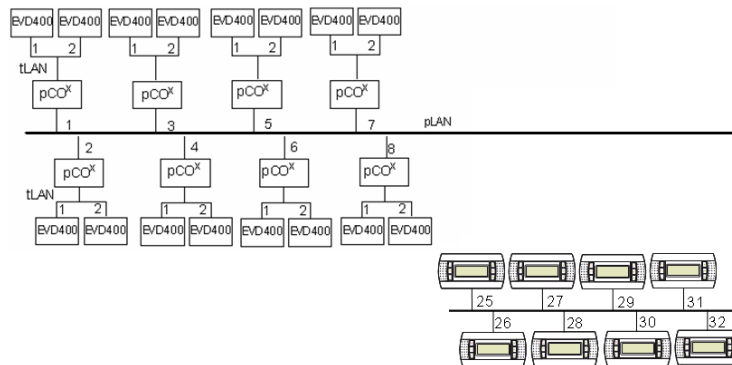

3.1 How to assign the pLAN addresses

The pLAN addresses must be unique and follow the layout shown above. There are various different ways to assign the pLAN address.

3.1.1 PGD0 terminal

To set the address of a PGD terminal (the default value is 32), proceed as follows:

1. Power up the terminal
2. Press the Up + Down + ENTER buttons until the "display address setting" screen is displayed
3. Enter the numeric pLAN address with the Up and Down buttons and then confirm by pressing Enter
4. The "No link" screen will be displayed
5. If the "No Link" screen is not displayed, press Up + Down + ENTER again
6. Once the "display address setting" screen is displayed, press Enter 3 times

When the "adr Priv/shard" screen is displayed, set the correct values and confirm with "YES".

3.1.2 Setting the address on the pCO^{xs}- pCO¹- pCO³

Operations required to set the pLAN address on the pCO¹ and pCO³ boards.

1. Power down the pCO* board and connect a PGD0 terminal with pLAN address "0".
2. Power up the pCO* board, by holding the Alarm + Up buttons until the "pLAN Address" screen appears.
3. When the "pLAN Address" screen is shown, follow the operations shown, i.e. enter the number (1,2,3...) of the pLAN address with the Up and Down buttons and then confirm by pressing Enter.
4. Power down the pCO* board.
5. If necessary, assign the correct pLAN address to the external terminal, if featured.
6. Power up the pCO* board.
7. Configure the pCO* to communicate speak with the terminal, if necessary.

3.1.3 Setting the address on the EVD400

To set the address of the EVD400 in both pLAN and tLAN, see the EVD400 manual (code +030220225).

4. Selecting the language

When the unit is switched on, by default a screen is displayed for selecting the language.

This screen is displayed for 30 seconds, after which the application automatically opens the main menu (screen M0).

The language automatically loaded is English, however this can be selected from the following options: English and Italian. To modify the language, proceed as follows:

1. press the Service button on the Built-in terminal or on the external PGD0* terminal press the Prg button and confirm the first item in the SERVICE menu by pressing the Enter button;
2. from screen "Ax", each time ENTER is pressed changes the interface language.

Screen "Pu" features a parameter for enabling the select language screen when starting the unit.

In this way, when the board is powered up, the desired language can be selected and confirmed by pressing ENTER.

5. Starting for the first time

After having checked the connections between the various boards and terminals, power up the pCO* board/boards. On power-up, the software automatically installs the default values chosen by CAREL for the unit configuration parameters. This section explains how to restore the default values and to return to the starting conditions. When starting for the first time, this operation is not required.

The following procedure is used to restore all the configuration parameters to the default values selected by CAREL.

CAUTION! this procedure irreversibly deletes any programming performed by the user.

As resetting the default values is an operation that involves each pCO* board, when more than one board is present, the procedure must be repeated for the all the boards. The procedure is identical for all the boards. Proceed as follows:

- press the "menu" and "prog" buttons on the LCD terminal at the same time (go to the manufacturer branch on the PGD0 terminal). When pressed, the LEDs corresponding to the "menu" and "prog" buttons will come on;
- enter the password using the "arrow" buttons and press Enter: this enters the "manufacturer" configuration branch:

```
+-----+
|Password      V0 |
|costruttore   |
|              |
|              0000|
+-----+
```

- enter the "Initialisation" branch:

```
+-----+
|Premere ENTER V1|
|per installare  |
|i valori di default|
|              |
+-----+
```

- press Enter to install the default values. The operation is completed when the message "Please wait...." is no longer displayed.

6. List of configurations

On power-up, the program recognises the type of board and the size, arranging the inputs and outputs as a consequence.

The following diagrams indicate the configuration of the inputs and outputs in the possible combinations.

6.1 Digital inputs

No.	pCO ³ - LARGE	pCO ¹³ - MEDIUM	pCO ⁸
ID 1	Antifreeze protection	Antifreeze protection	Antifreeze protection
ID 2	Dirty filter alarm	Dirty filter alarm	Dirty filter alarm
ID 3	Cooling/heating selection	Cooling/heating selection	Main fan thermal overload/generic interlock
ID 4	Main fan thermal overload	Main fan thermal overload/ generic interlock	Compressor thermal overload/High pressure switch
ID 5	Remote on-off	Remote on-off	Heater thermal overload
ID 6	Heater 1 thermal overload	Heater 1 thermal overload	Low pressure switch
ID 7	Low pressure switch circuit 1	Low pressure switch circuit 1	
ID 8	Comp. 1 thermal overload	Comp. thermal overload circuit 1	
ID 9	Low pressure switch circuit 2	Low pressure switch circuit 2	
ID 10	Comp. 2 thermal overload	Comp. thermal overload circuit 2	
ID 11	Heater 2 thermal overload	Heater 2 thermal overload	
ID 12	Flow switch	Flow switch	
ID 13	High pressure switch circuit 1	High pressure switch circuit 1	
ID 14	High pressure switch circuit 2	High pressure switch circuit 2	
ID 15	Comp. 3 thermal overload		
ID 16	Comp. 4 thermal overload		
ID 17	Serious generic alarm		
ID 18	Generic alarm, signal only		

6.2 Analogue inputs

No.	pCO ³ - LARGE	pCO ¹³ - MEDIUM	pCO ^{8S}
B 1	Ambient air relative humidity	Recirculation air relative humidity	Ambient air temperature
B 2	Outside air relative humidity	Outside air relative humidity	Outside air temperature
B 3	Cond. temperature/pressure circuit 1	Cond. temperature/pressure circuit 1	Outlet temperature
B 4	Outlet temperature	Cond. temperature/pressure circuit 2 (pCO1)	Condensing temperature/pressure
B 5	Ambient air temperature	Ambient air temperature	
B 6	Cond. temperature/pressure circuit 2	Outside air temperature	
B 7	Outside air temperature	Outlet temperature	
B 8	CO2 probe	Cond. temperature/pressure circuit 2 (pCO3)	

6.3 Digital outputs

No.	pCO ³ - LARGE	pCO ¹³ - MEDIUM	pCO ^{8S}
DO 1	Compressor 1 circuit 1	Compressor 1 circuit 1	Main fan
DO 2	Cond. fan circuit 1	Cond. fan circuit 1	Compressor contactor
DO 3	Cap. cont. comp. 1/ or comp. 2 circuit 1	Cap. cont. comp. 1/ or comp. 2 circuit 1	Heater
DO 4	Compressor 2 circuit 2 /comp. 3	Compressor 2 circuit 2 /comp. 3	General alarm
DO 5	Cond. fan circuit 2	Cond. fan circuit 2	Reversing valve
DO 6	Cap. cont. comp. 2 circuit 2/ comp. 4	Cap. cont. comp. 2 circuit 2/ comp. 4	
DO 7	Main fan	Main fan	
DO 8	General alarm	General alarm	
DO 9	Heater 1	Heater 1	
DO 10	Heater 2	Heater 2	
DO 11	Humidifier control	Humidifier control	
DO 12	Reversing valve circ.1	Reversing valve circ.1	
DO 13	Reversing valve circ.2	Reversing valve circ.2	
DO 14	Heat recovery digital output		
DO 15	Freecooling/freeheating active		
DO 16	Unit in heat pump operation		
DO 17	Heating valve status		

6.4 Analogue outputs

No.	pCO ³ - LARGE	pCO ¹³ - MEDIUM	pCO ^{8S}
AO 1	Outside air damper	Outside air damper	Outside air damper
AO 2	Heating valve	Heating valve	Heating valve
AO 3	Cond. fan 1 controller	Cond. fan 1 controller	Cond. fan controller
AO 4	Cond. fan 2 controller	Cond. fan 2 controller	
AO 5	Heat recovery analogue output		
AO 6	Modulating humidifier		

7. List of parameters

Parameter	Type	Ref.	Description	UOM	Range	Default	Notes
Q0 MAIN MENU (for 6-button terminal)							
MANUTENZIONE STORICO INGRESSI/USCITE OROLOGIO SET POINT UTENTE COSTRUTTORE ON/OFF UNITA' ESTATE/INVERNO SELEZIONE UNITA' DRIVERS	R	Q0	The UP & DOWN buttons can be used to select the menu item, the ENTER button enters the selected branch of screens.				
M0.1 to 4 MAIN loop (MENU button)							
Set °C	R	M1	Temperature set point	°C			
%	R	M1	Humidity set point	%			
°C	R	M1	Temperature of the environment being controlled	°C			
%rH	R	M1	Humidity of the environment being controlled	%	Screen Cb		
Stato unità	R	M1	Unit operating status (UNIT ON; OFF FROM ALARM; OFF FROM SUPERV.; OFF FROM TIME BANDS; OFF FROM DIN.; OFF FROM KEYPAD; MANUAL PROC.)				
hh:mm	R	M1	Hours, minutes indication				
Unità in	R	M2	Indicates the operating mode of the unit (HEATING, COOLING)		0, 1		
Fasce orarie	R	M2	The full symbol (•) indicates active time bands; the empty symbol (◦) indicates inactive time bands.		•/◦		
Deumidifica	R	M2	Indicates the dehumidifier activation status		•/◦		
Compensazione	R	M2	Indicates the activation status of the set point compensation function		•/◦		
Sbrin.r.cal.	R	M3	Indicates the defrost activation status during heat recovery		•/◦		
Sbrinamento	R	M3	Indicates the defrost activation status		•/◦		
Freecooling	R	M3	Indicates the freecooling activation status		•/◦		
Freeheating	R	M3	Indicates the freeheating activation status		•/◦		
Compressore 1	R	M4	Indicates the activation status of compressor 1		•/◦		
Compressore 2	R	M4	Indicates the activation status of compressor 2		•/◦		
Compressore 3	R	M4	Indicates the activation status of compressor 3		•/◦		
Compressore 4	R	M4	Indicates the activation status of compressor 4		•/◦		
Prevent	R	M5	Indicates the activation status of the high pressure prevent function		•/◦		
Limite mandata	R	M5	Indicates the activation status of the outlet limit function		•/◦		
Antigelo	R	M5	Indicates the activation status of the antifreeze function		•/◦		
I0.1 to 9,a,...,s INPUTS/OUTPUTS loop (I/O button)							
Sonda temperatura Interna	R	I0	Ambient temperature probe	°C			
Esterna	R	I0	Outside temperature probe	°C			
Sonda temperatura Mandata	R	I1	Outlet temperature probe	°C			
Sonda umidità Interna	R	I2	Ambient humidity probe	%	Screen Cb		
Esterna	R	I2	Outside humidity probe	%	Screen Cd		
Sonda Sbrinam.1	R	I3	Defrost probe 1	Screen C3	Screen Ch		
Sbrinam.2	R	I3	Defrost probe 2	Screen C3	Screen Gj		
Sonda Condens.1	R	I4	Condenser probe 1	Screen C3	Screen Ch		
Condens.2	R	I4	Condenser probe 2	Screen C3	Screen Gj		
Sonda Qualità aria CO2	R	I5	CO2 air quality probe. This screen is only enabled with the pCO3 Large board	ppm	Screen Cf		
Entalpia Interna	R	I6	Internal enthalpy value. This screen is displayed only if the freecooling and freeheating in heating mode are controlled by enthalpy.	kcal/kg			
Esterna	R	I6	External enthalpy value	kcal/kg			
Setpoint entalpia	R	I7	Value of the enthalpy set point. This screen is displayed only if the freecooling and freeheating in heating mode are controlled by enthalpy.	kcal/kg			
Ingressi digitali 01:07	R	I8	Status of digital inputs 1,2,3,7,8,9 (C: Closed; A: Open)		A/C		
04:10	R	I8	Status of digital inputs 4,5,6,10,11,12 (C: Closed; A: Open)		A/C		
Digital input 13:16	R	I9	Status of digital inputs 13,14,15,16,17,18 (C: closed; A: Open)		A/C		

Compressore 1	R	Ia	Status of compressor 1 (ON, OFF). This screen is enabled if the compressors are without capacity control.		ON / OFF		
Compressore 2	R	Ia	Status of compressor 2 (ON, OFF)		ON / OFF		
Compressore 3	R	Ia	Status of compressor 3 (ON, OFF)		ON / OFF		
Compressore 4	R	Ia	Status of compressor 4 (ON, OFF)		ON / OFF		
Compressore 1	R	Is	Status of compressor 1 (ON, OFF) This screen is enabled if the compressors feature capacity control.		ON / OFF		
Parz.1 comp.1	R	Is	Status of compressor capacity control 1		ON / OFF		
Compressore 2	R	Is	Status of compressor 2		ON / OFF		
Parz.1 comp.2	R	Is	Status of compressor capacity control 2		ON / OFF		
Vent.cond.1	R	Ib	Status of condenser fan 1		ON / OFF		
Vent.cond.2	R	Ib	Status of condenser fan 2		ON / OFF		
Valv.inv.1	R	Ib	Status of reversing valve 1		ON / OFF		
Valv.inv.2	R	Ib	Status of reversing valve 2		ON / OFF		
Vent.princ.	R	Ic	Status of the main fan		ON / OFF		
Umidificatore	R	Ic	Status of the humidifier		ON / OFF		
Resistenza 1	R	Id	Status of electric heater 1		ON / OFF		
Resistenza 2	R	Id	Status of electric heater 2		ON / OFF		
Serr.esterna	R	Ie	Status of the outside damper. This is displayed both as a percentage and in graphic format on a 20 segment bar.		0 to 100		
Valvola caldo	R	Ie	Status of the heating valve. This is displayed both as a percentage and in graphic format on a 20 segment bar		0 to 100		
Vent.cond.1	R	If	Status of condenser fan 1. This is displayed both as a percentage and in graphic format on a 20 segment bar		0 to 100		
Vent.cond.2	R	If	Status of condenser fan 2. This is displayed both as a percentage and in graphic format on a 20 segment bar		0 to 100		
Umidificatore	R	Ig	Status of the humidifier. This is displayed both as a percentage and in graphic format on a 20 segment bar		0 to 100		
Modem Stato:	R	Th	Status of the modem: Modem in standby, Initialisation, Searching GSM network, Modem in standby, Modem alarm, Initialising error, PIN error, GSM network not found, SMS saturation, Send SMS., Modem connected..., Call modem..)				
Recupero calore Rec.rotativo	R	Ii	Rotary heat recovery unit speed	%			
Condizioni	R	Ii	Double coil recovery unit condition: NOT OK, OK.				
Rotore	R	Ii	Status of the digital control of the rotor on the rotary heat recovery unit.				
Doppia batteria	R	Ii	Status of the circulating pump on the double coil recovery unit.				
Driver 1 Modalità EEV	R	Ij	EEV driver 1 operating mode: (AUTO: automatic, MAN: manual)				
Posizione EEV	R	Ij	Position of electronic valve EEV 1				
Pot.richiesta	R	Ij	Demand in circuit 1	%			
Driver 2 Modalità EEV	R	Ik	EEV driver 2 operating mode: (AUTO: automatic, MAN: manual)				
Posizione EEV	R	Ik	Position of electronic valve EEV 2				
Pot.richiesta	R	Ik	Demand in circuit 2	%			
Driver 1	R	Il	Type of gas in circuit 1: ---, R22, R134a, R404a, R407c, R410a, R507c, R290, R600, R600a, R717, R744, R728, R1270				1
SuperHeat	R	Il	Superheat value in circuit 1	°C			
Temp.sat.	R	Il	Saturation temperature in circuit 1	°C			
Temp.asp.	R	Il	Suction temperature in circuit 1	°C			
Driver 2	R	Im	Type of gas in circuit 2: ---, R22, R134a, R404a, R407c, R410a, R507c, R290, R600, R600a, R717, R744, R728, R1270				1
SuperHeat	R	Im	Superheat value in circuit 2	°C			
Temp.sat.	R	Im	Saturation temperature in circuit 2	°C			
Temp.asp.	R	Im	Suction temperature in circuit 2	°C			
Driver 1 Press.evap.	R	In	Evaporation pressure in circuit 1	barg			
Temp.evap.	R	In	Evaporation temperature in circuit 1	°C			
Temp.cond.	R	In	Condensing temperature in circuit 1	°C			
Driver 2 Press.evap.	R	Io	Evaporation pressure in circuit 2	barg			
Temp.evap.	R	Io	Evaporation temperature in circuit 2	°C			
Temp.cond.	R	Io	Condensing temperature in circuit 2	°C			
Protezione D1 Basso SHeat	R	Ip	Enable low superheat protection for Driver 1: No, Yes		No, Yes		
Alta T.cond.	R	Ip	Enable high condensing temperature protection for Driver 1: No, Yes		No, Yes		
LOP	R	Ip	Enable LOP protection for Driver 1: No, Yes		No, Yes		

MOP	R	Ip	Enable MOP protection for Driver 1: No, Yes		No, Yes		
Protezione D2 Basso SHeat	R	Ip	Enable low superheat protection for Driver 2: No, Yes		No, Yes		
Alta T.cond.	R	Ip	Enable high condensing temperature protection for Driver 2: No, Yes		No, Yes		
LOP	R	Ip	Enable LOP protection for Driver 2: No, Yes		No, Yes		
MOP	R	Ip	Enable MOP protection for Driver 2: No, Yes		No, Yes		
Driver 1 ver.	R	Ir	Firmware version Driver 1				
Driver 2 ver.	R	Ir	Firmware version Driver 2				
S0,S1 to 3 SET POINT loop (SET button)							
Setpoint Temp. Est	R/W	S0	Temperature set point in COOLING mode	°C	Screen P3	25.0	
Setpoint Temp. Inv	R/W	S1	Temperature set point in HEATING mode	°C	Screen P3	21.0	
Setpoint umidità Est	R/W	S2	Humidity set point COOLING mode. This screen is displayed if humidity control is enabled.	%	Screen Pb	50.0	
Setpoint umidità Inv	R/W	S3	Humidity set point HEATING mode. This screen is displayed if humidity control is enabled.	%	Screen Pb	50.0	
P0,P1 to 9,a,b, to z USER loop (PROG button)							
Inserire password	R/W	P0	Screen to access the user branch		0 to 9999		
Abilitazione Compressore 1	R/W	P1	Enable operation of compressor 1		Y/N		
Compressore 2	R/W	P1	Enable operation of compressor 2		Y/N		
Compressore 3	R/W	P2	Enable operation of compressor 3		Y/N		
Compressore 4	R/W	P2	Enable operation of compressor 4		Y/N		
Limite setpoint Temperatura Superiore	R/W	P3	Temperature set point upper limit	°C	-99.9 to 99.9	35.0	
Inferiore	R/W	P3	Temperature set point lower limit	°C	-99.9 to 99.9	5.0	
Banda regol.temp. Estate	R/W	P4	Temperature control differential in COOLING mode	°C	0 to 15.0	3.0	
Inverno	R/W	P4	Temperature control differential in HEATING mode	°C	0 to 15.0	3.0	
Zona neutra	R/W	P4	Temperature control dead zone	°C	0 to 3.0		
Compens. Estiva Temp.esterna	R/W	P5	Outside temperature set point for activating compensation. This screen is displayed if set point compensation is enabled. Parameters for compensation control in COOLING mode.	°C	-99.9 to 99.9	30.0	
Diff.	R/W	P5	Compensation differential that determines the range of variation of the set point.	°C	-99.9 to 99.9	5.0	
Max compens.	R/W	P5	Maximum compensation allowed	°C	0 to 99.9	5.0	
Compens. inv. Temp.esterna	R/W	P6	Outside temperature set point for activating compensation. This screen is displayed if set point compensation is enabled. Parameters for compensation control in HEATING mode.	°C	-99.9 to 99.9	0	
Diff.	R/W	P6	Compensation differential that determines the range of variation of the set point.	°C	-99.9 to 99.9	5.0	
Max compens.	R/W	P6	Maximum compensation allowed	°C	0 to 99.9	5.0	
Limite minimo Temperatura mandata Setpoint	R/W	P7	Minimum outlet temperature limit set point. This screen is displayed if the outlet temperature probe is enabled.	°C	-99.9 to 99.9	15.0	
Diff.	R/W	P7	Minimum outlet temperature limit differential	°C	-99.9 to 99.9	3.0	
Limite massimo Temperatura mandata setpoint	R/W	PA	Maximum set point outlet limit temperature	°C	-99.9 to 99.9	30.0	
Diff.	R/W	PA	Maximum outlet limit temperature differential	°C	-99.9 to 99.9	3.0	
Antigelo durante OFF unità Set T.mandata	R/W	PB	Outlet temperature set point for the antifreeze function (unit OFF)	°C	-9.9 to 9.9	2.0	
Diff.T.mandata	R/W	PB	Outlet temperature differential for the antifreeze function (unit OFF)	°C	0 to 9.9	0.5	
Antigelo durante OFF unità Apertura valvola	R/W	PC	Heating valve opening in antifreeze when unit off	%	0 to 99	30	
Soglia temp. Interna estiva Superiore	R/W	P8	High ambient temperature alarm threshold in COOLING mode.	°C	-99.9 to 99.9	32.0	
Inferiore	R/W	P8	Low ambient temperature alarm threshold in COOLING mode.	°C	-99.9 to 99.9	20.0	
Soglia temp. interna invernale Superiore	R/W	P9	High ambient temperature alarm threshold in HEATING mode. This screen is displayed if heat pump control is enabled.	°C	-99.9 to 99.9	26.0	
Inferiore	R/W	P9	Low ambient temperature alarm threshold in HEATING mode.	°C	-99.9 to 99.9	17.0	
Ritardo allarme alta/bassa temp.interna	R/W	Pa	High/low ambient temperature alarm delay	minutes	0 to 999	30	

Abil.flussostato	R/W	Pa	Enable air flow control		0.1		
Limite Setpoint umidità Superiore	R/W	Pb	Humidity set point upper limit. This screen is displayed if humidity control is enabled.	%	-99.9 to 99.9	80.0	
Inferiore	R/W	Pb	Humidity set point lower limit.	%	-99.9 to 99.9	25.0	
Banda reg.umidità Estate	R/W	Pc	Humidity control differential in COOLING mode. This screen is displayed if humidity control is enabled.	%	0 to 20.0	5.0	
Inverno	R/W	Pc	Humidity control differential in HEATING mode.	%	0 to 20.0	5.0	
Zona neutra	R/W	Pc	Dead zone humidity control	%	0 to 5.0		
Abilitazione Resistenza 1	R/W	Pd	Enable operation of electric heater 1. This screen is displayed if at least one heater is enabled.				
Resistenza 2	R/W	Pd	Enable operation of electric heater 2.				
Resistenze (Setpoint invernale) Offset	R/W	Pe	Heater offset with heating set point. This screen is displayed if at least one heater is enabled.	°C	-99.9 to 99.9	8.0	
Diff.	R/W	Pe	Heater control differential with heating set point.	°C	-99.9 to 99.9	2.0	
Reg.valv.caldo (Setpoint invernale) Offset	R/W	Pf	Heating valve offset with heating set point. This screen is displayed if heating valve control is enabled.	°C	0 to 999	6.0	
Diff.	R/W	Pf	Heating valve control differential with heating set point	°C	0 to 999	2.0	
Qualità aria CO2 Setpoint	R/W	Pg	CO2 air quality control set point. This screen is displayed if the CO2 air quality probe is enabled.	ppm	0 to 2500	500	
Diff.	R/W	Pg	CO2 air quality control differential.	ppm	0 to 999	100	
Zona neutra	R/W	Pg	CO2 air quality control dead zone.	ppm	0 to 999		
Delta freecool/heating in temperatura	R/W	Ph	Temperature differential for the activation of freecooling and freeheating. This screen is displayed if freecooling management is enabled.	°C	-99.9 to 99.9	3.0	
Freecool/heating differenziale in entalpia	R/W	Pi	Enthalpy differential for controlling the opening of the damper. This screen is displayed if freecooling by enthalpy is enabled.	kcal/kg	-999.9 to 999.9	10	
Serr.freecooling (Setpoint estivo) Offset	R/W	Pj	Outside freecooling damper control offset with cooling set point. This screen is displayed if freecooling in cooling mode is enabled.	°C	-99.9 to 99.9	-2.0	
Diff.	R/W	Pj	Outside freecooling damper control differential with cooling set point.	°C	-99.9 to 99.9	2.0	
Serr.freecooling (Setpoint invernale) Offset	R/W	Pk	Outside freecooling damper control offset with heating set point. This screen is displayed if freecooling in heating is enabled.	°C	-99.9 to 99.9	2.0	
Diff.	R/W	Pk	Outside freecooling damper control differential with heating set point.	°C	-99.9 to 99.9	2.0	
Minima aperture Serr.esterna	R/W	Pl	Minimum opening of the outside damper with unit ON.	%	0 to 99	25	
Apertura invernale serr.esterna	R/W	Pl	During start-up or after a blackout, the outside damper remains completely closed (0 Volt) until the ambient temperature reaches the control set point. (Only in heating operation) 0: Normal; 1: Closed.		0.1	0	
Forza freecooling All'accensione	R/W	Pm	Force freecooling when starting the unit to refresh the air in the environment.		0.1		
Durata forzatura freecooling	R/W	Po	Time for forcing freecooling when starting the unit.	minutes	0 to 999	30	
Regol. temp./umidità durante forzatura	R/W	Po	Enable control during forced freecooling when starting.		0.1		
Defrost Ritardo inizio	R/W	Pn	Defrost activation delay. This screen is displayed if heat pump control is enabled.	minutes	0 to 999	30	
Tempo max	R/W	Pn	Maximum defrost duration. If the defrost does not end by temperature it is stopped after this time has elapsed.	minutes	0 to 999	5	
Attivazione recupero calore Delta temp.	R/W	Pw	Heat recovery activation set point. If the difference between the outside temperature and the inlet temperature is equal to or greater than the temperature delta, heat recovery is activate. This screen is displayed if heat recovery is enabled.	°C	0 to 99.9	5.0	
Diff.	R/W	Pw	Heat recovery control differential	°C	0 to 99.9	1.0	
Temp.regol.recup. Diff.	R/W	Px	Heat recovery control by temperature differential.	°C	0 to 99.9	7.0	
Zona neutra	R/W	Px	Heat recovery control by temperature dead zone	°C	0 to 99.9	1.0	
Diff.NZ	R/W	Px	Heat recovery control by temperature differential.	°C	0 to 99.9	1.0	
Entalpia reg.rec. Diff.	R/W	PY	Heat recovery control by enthalpy differential	kcal/kg	0 to 99.9	2.0	
Zona neutra	R/W	PY	Heat recovery control by enthalpy dead zone.	kcal/kg	0 to 99.9	1.0	

Sbrin.recupero Setpoint	R/W	Pz	Defrost set point in heat recovery. If the outside temperature is less than the set point the defrost is active.	°C	-99.9 to 99.9	-2.0	
Diff.	R/W	Pz	Defrost control differential in heat recovery.	°C	0 to 99.9	3.0	
Rit.	R/W	Pz	Defrost activation delay in heat recovery.	minutes	0 to 99	5	
Veloc.	R/W	Pz	Rotor speed during defrost when rotary heat recovery is configured.	%	0 to 100	50	
Abilitazione ON/OFF remoto	R/W	Pp	Enable unit On/Off from digital input		Y/N		
ON/OFF da superv.	R/W	Pp	Enable unit On/Off from the supervisor		Y/N		
ON dopo blackout	R/W	Pp	Enable automatic restart (Unit On) after a blackout.		Y/N	S	
Numero identific. per rete BMS	R/W	Pq	Board identification number for supervisory network		1 to 200	1	
Baud rate	R/W	Pq	Board communication speed for supervisory network: 1200 (RS485-RS422), 2400 (RS485-RS422), 4800 (RS485-RS422), 9600 (RS485 only), 19200 (RS485 only)	bps	0,1,2,3,4	4	
Protocollo	R/W	Pq	Type of protocol used (CAREL, MODBUS, LON, RS232, GSM, WINLOAD)				
Num.squilli:	R/W	Pr	Number of modem rings (analogue modem)				
Max.num.rubic:	R/W	Pr	Telephone numbers entered in phone book				
Numero cellulare	R/W	Pr	Telephone number for sending SMS messages. (GSM modem)				
Visual.numero	R/W	Pr	Display number (analogue modem)				
Modem password	R/W	Pr	Password for sending SMS messages.				
Num.squilli:	R/W	Ps	Number of rings (external modem only)				
Tipo modem	R/W	Ps	Type of modem: TONE or PULSE				
Testo SMS Maschera d'allarme	R/W	Pt	Customised text string sent with the alarm SMS.				
Visualizza maschera lingua all'acc.	R/W	Pu	Enable display language selection screen when starting the unit.		Y/N	S	
Nuova password utente	R/W	Pv	Set new user branch password.				

K0,K1 to 8 CLOCK loop (CLOCK button)

Orologio Ora	R/W	K0	Set current time: hours and minutes	hh:mm	0 to 24; 0 to 59		
Data	R/W	K0	Set current date: day, month and year	dd/mm/yy	1 to 31 / 1 to 12 / 0 to 99		
Inserire password	R/W	K1	Screen for accessing the clock branch.		0 to 9999		
Abilita fasce Orarie giornaliere	R/W	K2	Enable time bands		Y/N		
Abilita off ventil. princ.da fascia	R/W	K2	Enable fan shutdown from time bands		Y/N		
Fasce orarie Giornaliere Inizio	R/W	K3	Set start time band. This screen is displayed if the time bands are enabled.	hh:mm	0 to 24; 0 to 59		
Fine	R/W	K3	Set end time band.	hh:mm	0 to 24; 0 to 59		
Fasce orarie Funzionamento estivo Set interno	R/W	K4	Set inside set point for time bands in cooling operation.	°C	-99.9 to 99.9	25.0	
Set esterno	R/W	K4	Set outside set point for time bands in cooling operation.	°C	-99.9 to 99.9	20.0	
Fasce orarie Funz.invernale Set interno	R/W	K5	Set inside set point for time bands in heating operation.	°C	-99.9 to 99.9	21.0	
Set esterno	R/W	K5	Set outside set point for time bands in heating operation.	°C	-99.9 to 99.9	18.0	
Abilita OFF Unità da fascia settimanale	R/W	K6	Enable shutdown from weekly time bands		Y/N		
Fasce orarie Lun	R/W	K7	Enable weekly time bands, Monday. This screen is displayed if the weekly time bands are enabled.		Y/N		
Mar	R/W	K7	Enable weekly time bands, Tuesday.		Y/N		
Mer	R/W	K7	Enable weekly time bands, Wednesday.		Y/N		
Gio	R/W	K7	Enable weekly time bands, Thursday.		Y/N		
Ven	R/W	K7	Enable weekly time bands, Friday.		Y/N		
Sat	R/W	K7	Enable weekly time bands, Saturday.		Y/N		
Dom	R/W	K7	Enable weekly time bands, Sunday.		Y/N		
Nuova password	R/W	K8	Set new password for the clock branch.		0 to 9999		

A0,A1 to 9,a,b to w SERVICE loop (SERV button)

CAREL S.p.A. Codice:FLSTDmRT0E Ver.:1.0 gg/mm/aa	R	A0	Display the code, version and date of the software.				
Language	R/W	A0	Select the interface language		Italian/English		
Bios:x.xx dd/mm/yy Boot:x.xx dd/mm/yy	R	A1	Display the version and date of the Boot and the Bios installed on the board.				
Hardware installato	R	A2	Display the type of board installed (pCOxs, pCO1, pCO3) and the				

scheda: pCOxx Tipo : sssss			size of the board (small, medium or large)				
Ore funzionamento unità	R	A3	Display the operating hours of the unit.	h	0 to 999999		
Ore funzionamento Comp.1	R	A4	Display the operating hours of compressor 1.	h	0 to 999999		
Comp.2	R	A4	Display the operating hours of compressor 2.	h	0 to 999999		
Ore funzionamento Comp.3	R	A5	Display the operating hours of compressor 3.	h	0 to 999999		
Comp.4	R	A5	Display the operating hours of compressor 4.	h	0 to 999999		
Inserire password	R/W	A6	Screen for accessing the service branch, password protected.		0 to 9999		
Soglia tempo funzionamento unità	R/W	A7	Set unit operating hour threshold	h	1 to 999000	20000	
Soglia tempo funzionamento Comp.1	R/W	A8	Set compressor 1 operating hour threshold.	h	1 to 999000	10000	
Soglia tempo funzionamento Comp.2	R/W	A9	Set compressor 2 operating hour threshold.	h	1 to 999000	10000	
Soglia tempo funzionamento Comp.3	R/W	Aa	Set compressor 3 operating hour threshold.	h	1 to 999000	10000	
Soglia tempo funzionamento Comp.4	R/W	Ab	Set compressor 4 operating hour threshold.	h	1 to 999000	10000	
Reset contaore unità	R/W	Ac	Reset unit operating hours		Y/N		
Reset contaore Compressore 1	R/W	Ad	Reset compressor 1 operating hours.		Y/N		
Compressore 2	R/W	Ad	Reset compressor 2 operating hours.		Y/N		
Reset contaore Compressore 3	R/W	Ae	Reset compressor 3 operating hours.		Y/N		
Compressore 4	R/W	Ae	Reset compressor 4 operating hours.		Y/N		
Calibrazione sonda Temperatura Int.	R/W	Af	Ambient temperature probe calibration. The probe reading is displayed to the right of the calibration field.	°C	-9.9 to 9.9		
Man.	R/W	Af	Outlet temperature probe calibration. The probe reading is displayed to the right of the calibration field.	°C	-9.9 to 9.9		
Calibrazione sonda Temperatura Est.	R/W	Ag	Outside temperature probe calibration. The probe reading is displayed to the right of the calibration field.	°C	-9.9 to 9.9		
Calibrazione sonda umidità Int.	R/W	Ah	Ambient humidity probe calibration. The probe reading is displayed to the right of the calibration field.	%	-9.9 to 9.9		
Est.	R/W	Ah	Outside humidity probe calibration. The probe reading is displayed to the right of the calibration field.	%	-9.9 to 9.9		
Calibrazione sonda sbrinamento S.1	R/W	Ai	Defrost probe 1 calibration. The probe reading is displayed to the right of the calibration field.	°C	-9.9 to 9.9		
S.2	R/W	Ai	Defrost probe 2 calibration. The probe reading is displayed to the right of the calibration field.	°C	-9.9 to 9.9		
Calibrazione sonda qualità aria CO2	R/W	Aj	CO2 air quality probe calibration. The probe reading is displayed to the right of the calibration field.	ppm	-99 to 99		
Offset sonde Drv1 S1	R/W	Ak	Probe S1 calibration driver 1.	°C/barg	-9.9 to 9.9		
S2	R/W	Ak	Probe S2 calibration driver 1.	°C/barg	-9.9 to 9.9		
S3	R/W	Ak	Probe S3 calibration driver 1.	°C/barg	-9.9 to 9.9		
Offset sonde Drv2 offset S1	R/W	Al	Probe S1 calibration driver 2.	°C/barg	-9.9 to 9.9		
S2	R/W	Al	Probe S2 calibration driver 2.	°C/barg	-9.9 to 9.9		
S3	R/W	Al	Probe S3 calibration driver 2.	°C/barg	-9.9 to 9.9		
Cancellazione storico allarmi	R/W	Am	Delete the alarm log.		Y/N		
Test dout Ventil.principale	R/W	An	Test the operation of the main fan.		Y/N		
Compressore 1	R/W	An	Test the operation of compressor 1.		Y/N		
Compressore 2	R/W	An	Test the operation of compressor 2.		Y/N		
Test dout Compressore 3	R/W	Ao	Test the operation of compressor 3.		Y/N		
Compressore 4	R/W	Ao	Test the operation of compressor 4.		Y/N		
Test dout Valvola invers.1	R/W	Ap	Test the operation of reversing valve 1.		Y/N		
Valvola invers.2	R/W	Ap	Test the operation of reversing valve 2.		Y/N		
Test dout Resistenza 1	R/W	Aq	Test the operation of electric heater 1.		Y/N		
Resistenza 2	R/W	Aq	Test the operation of electric heater 2.		Y/N		
Test dout Umidificatore	R/W	Ar	Test the operation of the humidifier.		Y/N		
Condensatore 1	R/W	Ar	Test the operation of condenser fan 1.		Y/N		
Condensatore 2	R/W	Ar	Test the operation of condenser fan 2.		Y/N		

Proc.man.driver 1 Modalità EEV	R/W	As	Manual procedure Driver 1. EEV operating mode: 0: AUTO 1: MAN		0,1		
Passi richiesti	R/W	As	Number of manual valve opening steps Driver 1		0 to maximum number of steps, driver 1		
Posizione EEV	R	As	Display current valve opening steps Driver 1				
Proc.man.driver 2 Modalità EEV	R/W	At	Manual procedure Driver 2. EEV operating mode: 0: AUTO 1: MAN		0,1		
Passi richiesti	R/W	At	Number of manual valve opening steps Driver 2.		to maximum number of steps, driver 2		
Posizione EEV	R	At	Display current valve opening steps Driver 2.				
Driver 1 status Sist. in attesa per Ignorare?	R	Au	Driver 1 status: NO FAULT, OPEN VALVE RESTART, BATTERY CHARGING, EEPROM ERROR Manually release Driver 1 when starting.				
Driver 2 status Sist. in attesa per Ignorare?	R	Av	Driver 2 status: NO FAULT, OPEN VALVE RESTART, BATTERY CHARGING, EEPROM ERROR Manually release Driver 2 when starting.				
Inserire nuova Password	R/W	Aw	Set new service branch password		0 to 9999		
Z0,Z1 MANUFACTURER loop (MENU-PROG buttons)							
Inserire password	R/W	Z0	Screen for accessing the manufacturer branch.		0 to 9999		
Configurazione Parametri Tempistiche Inizializzazione	R	Z1	The manufacturer parameters are divided into four branches. The UP & DOWN buttons can be used to select the manufacturer menu item, and the Enter button accesses the selected branch of screens.				
C0,C1 to 9,a,b,..p MANUFACTURER loop, CONFIGURATION submenu							
Num. compressori	R/W	C0	Number of compressors controlled (---.1 COMPRESS., 1 COMP. +1 STEP, 2 COMPRESSORS, 2 COMP. +2 STEPS, 4 COMPRESSORS)		1 to 5	1 COMP.	
Numero circuiti	R/W	C0	The number of circuits will have a fixed value in the following cases: 1 compressor = 1 circuit 4 compressors = 2 circuits In the other cases, the number of circuits is set by parameter.		1,2		
Logica parz.	R/W	C0	Set capacity-control logic: N.O. = Normally open N.C. = Normally closed		0,1		
Ab.rot.comp.	R/W	C1	Enable compressor rotation		Y/N	Y	
Potenza equalizz.	R/W	C1	Enable capacity balancing		Y/N		
Pompa calore	R/W	C1	Enable heat pump operation		Y/N		
Logica valv.inv.	R/W	C1	Set reversing valve logic: N.O. = Normally open N.C. = Normally closed				
Valvola caldo	R/W	C2	Enable heating valve		Y/N		
Num.resistenze	R/W	C2	Set number of electric heaters		0,1,2	0	
Tipo riscaldamento	R/W	C2	Set type of heating: - Heaters only; - Heating valve only; - Heaters + Heating valve.		HEATERS ONLY, HOT VALVE ONLY, HEAT+HOT VALVE		
Enable post heating in dehumidification	R/W	Cr	Enable post heating during dehumidification		Y/N	N	
En.summer heating:	R/W	Cr	Enable heating in summer		Y/N	N	
Regol.vent.cond.	R/W	C3	Set type of condenser control: - By compressor; - By pressure; - By temperature.		BY COMPRESSOR, BY PRESSURE, BY TEMPERATURE		
Tipo	R/W	C3	Set type of condenser control		MODULATING, ON/OFF		
Sbrin.in	R/W	C3	Set type of defrost control: - Temperature; - Pressure.		TEMPERATURE, PRESSURE		
Freecooling est.	R/W	C4	Enable freecooling in cooling		Y/N		
Freeheating inv.	R/W	C4	Enable freeheating in heating		Y/N		
Freecooling inv.	R/W	C4	Enable freecooling in heating		Y/N		
Controllo Freecooling e Freeheating	R/W	C5	Set type of freecooling/freeheating control: - Temperature;				

inverno in			- Enthalpy. This screen is displayed if freecooling/freeheating is enabled.				
Selezione Est./Inv.	R/W	C6	Set change in operating mode: - From terminal; - From digital input; - From control probe.		PANEL, REMOTE, AUTOMATIC		
Gestione umidità	R/W	C6	Enable humidity control		Y/N		
Sonda temperatura Interna Tipo	R/W	C7	Set type of ambient temperature probe: - NTC; - PT1000.		NTC, PT1000	0	
Sonda temperatura Esterna	R/W	C8	Enable outside temperature probe		Y/N		
Tipo	R/W	C8	Set type of outside temperature probe: - NTC; - PT1000.NTC;Pt100 - PT1000.		NTC, PT1000	0	
Sonda temperatura mandata	R/W	C9	Enable outlet temperature probe		Y/N		
Tipo	R/W	C9	Set type of outlet temperature probe: - NTC; - PT1000.		NTC, PT1000	0	
Sonda umidità interna	R/W	Ca	Enable ambient humidity probe		Y/N		
Tipo	R/W	Ca	Set type of ambient humidity probe: - 0-1 V; - 0-10 V; - 4-20mA; - 0-20mA; - 0-5 V.		0-1V, 0-10V, 4-20mA, 0-20mA, 0-5 V	2	
Limiti sonda Umidità interna Min	R/W	Cb	Set ambient humidity probe lower limit	%	0 to 99.9	10.0	
Max	R/W	Cb	Set ambient humidity probe upper limit	%	Lower ambient humidity limit to 100.0	90.0	
Sonda umidità esterna	R/W	Cc	Enable outside humidity probe		Y/N		
Tipo	R/W	Cc	Set type of outside humidity probe: - 0-1 V; - 0-10 V; - 4-20mA; - 0-20mA; - 0-5 V.		0-1V, 0-10V, 4-20mA, 0-20mA, 0-5 V	2	
Limiti sonda Umidità esterna Min	R/W	Cd	Set outside humidity probe lower limit	%	0 to 99.9	10.0	
Max	R/W	Cd	Set outside humidity probe upper limit	%	Min. outside humid. limits to 100.0	90.0	
Sonda qualità aria CO2	R/W	Ce	Enable CO2 air quality probe.		Y/N		
Tipo	R/W	Ce	Set type of CO2 air quality probe: - 0-1 V; - 0-10 V; - 4-20mA; - 0-20mA; - 0-5 V.		0-1V, 0-10V, 4-20mA, 0-20mA, 0-5 V	2	
Limiti sonda CO2 Limite min.	R/W	Cf	Set CO2 air quality probe lower limit	ppm	0 to 2000	0	
Limite max	R/W	Cf	Set CO2 air quality probe upper limit	ppm	0 to 2000	2000	
Sonda sbrinamento 1	R/W	Cg	Enable condenser/defrost probe 1		Y/N		
Tipo	R/W	Cg	Set type of defrost probe 1: - 4-20mA; - 0-5 V.		4-20mA, 0-5 V	0	
Limiti sonda Sbrinamento 1 Min	R/W	Ch	Set defrost probe 1 lower limit	bar	-99.9 to 99.9	0	
Max	R/W	Ch	Set defrost probe 1 upper limit	bar	-99.9 to 99.9	30.0	
Sonda sbrinamento 2	R/W	Ci	Enable condenser/defrost probe 2		Y/N		
Tipo	R/W	Ci	Set type of defrost probe 2: - 4-20mA; - 0-5 V.		4-20mA, 0-5 V	0	
Limiti sonda Sbrinamento 2 Min	R/W	Cj	Set defrost probe 2 lower limit	bar	-99.9 to 99.9	0	

Max	R/W	Cj	Set defrost probe 2 upper limit	bar	-99.9 to 99.9	30.0	
Abilita recupero calore	R/W	Ck	Enable heat recovery		Y/N	N	
	R/W	Ck	Set type of heat recovery unit		CROSS-FLOW, ROTARY, DOUBLE COIL	1	
Serranda by-pass Tipo	R/W	Cq	Select/enable the type of bypass damper		NO, DIGITAL, ANALOGUE	2	
Posizione	R/W	Cq	Select the position of the bypass damper		ON RECOVERY UNIT, ADDITIONAL DAMPER		
Recupero calore Tipo rotore	R/W	Cn	Set type of rotary heat recovery unit rotor (digital for cross-flow recovery unit or the digital input to be used when the bypass damper is not on the recovery unit but is an additional damper): - Digital; - Analogue.		DIGITAL, MODUL.	1	
Logica uscita dig.	R/W	Cn	Heat recovery digital output logic (0: N.O., 1: N.C.) Set rotary heat recovery unit rotor logic: - N.O. (Normally open) - N.C. (Normally closed)		N.O., N.C.		
Recupero calore Min.vel.rotore	R/W	Co	Set minimum rotation speed of rotary heat recovery unit	%	0 to 100	20	
Min.apert.damp.	R/W	Co	Minimum bypass damper opening	%	0 to 100	20	
Recupero calore Sonda di regolazione	R/W	Cp	Set type of heat recovery control: - Ambient temperature; - Outlet temperature; - Ambient enthalpy.		AMBIENT TEMPERATURE, OUTLET TEMPER., AMBIENT ENTHALPY	2	
Abilitazione Drivers EVD400	R/W	C1	Enable EVD400 driver		Y/N	N	
Scheda orologio	R/W	Cm	Enable clock board		Y/N	S	
Frequenza rete	R/W	Cm	Reference frequency: - 50 Hz; - 60 Hz.		50Hz, 60Hz		

GO,G1 to 9,a,b MANUFACTURER loop, PARAMETERS submenu

Regolazione temperatura	R/W	G0	Type of temperature control: - P (Proportional); - P+I (Proportional + integral).		P; P+I		
Tempo integrazione reg. P+I	R/W	G0	Integral time for P+I control.	s	0 to 999	600	
Compensazione setpoint	R/W	G1	Enable temperature set point compensation		Y/N	N	
Pressione atm. per calcolo entalpia	R/W	G2	Set the atmospheric pressure for the calculation of the enthalpy.	mbar	600 to 1100	1000	
Setpoint sbrinamento Inizio	R/W	G3	Set the start defrost set point	Screen C3	-99.9 to 99.9	1.5	
Fine	R/W	G3	Set the end defrost set point	Screen C3	-99.9 to 99.9	14.0	
Off vent.princ. durante sbrinam.	R/W	G4	Enable main fan shutdown during the defrost		Y/N	Y	
Circuiti in sbrinam.contemp.	R/W	G4	Enable simultaneous defrosts.		Y/N		
Sbrinam.contemp. Fine sbrinam.con sonda alla minima	R/W	G5	Enable end simultaneous defrost when reaching the minimum value of: - Temperature; - Pressure. (Set screen C3)	Screen C3	Y/N		
Num.compressori in deumidifica	R/W	G6	Set the number of compressors enabled for operation during the dehumidification phase		0, 1, 2	1	
Ventilatore di condensazione Setpoint	R/W	G7	Set the control set point for the condenser fans controlled by temperature.	Screen C3	0 to 99.9	14.0	
Diff.	R/W	G7	Set the control differential for the condenser fans controlled by temperature.	Screen C3	0 to 99.9	6.0	
Ventilatore di Evaporazione Setpoint	R/W	G8	Set the control set point for the evaporator fans	Screen C3	0 to 99.9	8.0	
Diff.	R/W	G8	Set the control differential for the evaporator fans of the fans	Screen C3	0 to 99.9	4.0	
Inverter Velocità max a	R/W	G9	Set the maximum speed (value expressed in Volt) reached by the inverter	V	0 to 10.0	10.0 V	
Velocità min a	R/W	G9	Set the minimum speed (value expressed in Volt) reached by the inverter	V	0 to 10.0	0 V	
Tempo speed up	R/W	G9	Set operating time at maximum speed when starting the condenser inverter	s	0 to 999	3	
Abil.prevent.	R/W	Ga	Enable prevent function on condenser		Y/N	Y	

Set point	R/W	Ga	Prevent function set point on condenser	Screen C3	-99.9 to 99.9	20.0	
Differenziale	R/W	Ga	Prevent function differential on condenser	Screen C3	0 to 99.9	2.0	
Ritardo output	R/W	Ga	Prevent delay activation.	s	0 to 999	0	
Ventilatori di condensazione binati	R/W	Gb	Enable coupled operation of the condenser fans		Y/N		
T0,T1 to 6 MANUFACTURER loop, TIMES submenu							
Minimo tempo Off compressore	R/W	T0	Set minimum compressor off time	s	0 to 9999	180	
Minimo tempo On compressore	R/W	T0	Set minimum compressor on time	s	0 to 9999	60	
Tempo tra On stesso comp.	R/W	T1	Set time between activations of the same compressor	s	0 to 9999	360	
Tempo tra On diversi.comp.	R/W	T1	Set time between activations of different compressors	s	0 to 9999	10	
Ritardo allarme Bassa pressione	R/W	T2	Set the delay time for the low pressure alarm.	s	0 to 9999	120	
Ritardo allarme flussostato Partenza	R/W	T3	Set the delay time for the air flow alarm when starting the unit	s	0 to 999		
Regime	R/W	T3	Set the delay time for the air flow alarm in steady operation.	s	0 to 999		
Ritardo Off ventil.princ.	R/W	T4	Set the main fan off delay	s	0 to 999	20	
Ritardo partenza compressore	R/W	T4	Set the compressor start delay	s	0 to 999	60	
Off forzato Compressore durante Inizio/fine sbrinamento	R/W	T5	Set the compressor off time during start and end defrost.	s	0 to 999		
Ritardo allarme filtro	R/W	T6	Set the dirty filter alarm delay time.	s	0 to 999	5	
Ritardo partenza tra comp.e parz.	R/W	T6	Set the delay time between start compressor and start capacity-control.	s	0 to 999	5	
V0,V1 to 2 MANUFACTURER loop, INITIALISATION submenu							
Inserire nuova password	R/W	V0	Set new manufacturer branch password.		0 to 9999		
Premere ENTER per installare valori di default	R/W	V1	Install default values.				
EVD MENU							
PARAM.DI SIST.EVD AUTOSETUP PARAMETRI ADVANCED	R		The UP & DOWN buttons can be used to select the menu item, and the Enter button accesses the selected branch of screens.				
F1 to Fc EVD SYSTEM PARAMETERS							
Tipo EVD	F1	R/W	Select the type of network	-	EVD400 pLAN EVD400 tLAN	1	
Abilita batteria	F1	R/W	Enable battery	-	Y/N		
Tipo sonde EVD	F2	R/W	Select the type of probes -Not selected -SHeat NTC-P(4-20)mA -SHeat NTC-P(rat) -SHeat NTC-NTC -SHeat PT1000-P -SHeat NTC HT-P(rat) -PID Press -PID NTC -PID NTC HT -PID PT1000	-	0 to 9	0	
Tipo driver	F2	R	Type of driver -NTC>S3 P(rat)>S1 -NTCsuct>S3 NTCsat>S1 -PT1000>S2 P(rat)>S1 -NTCh>S2 P(rat)>S1	-			
Direzione PID	F2	R/W	Direction of the PID when the type of probe selected is "PID Press" -DIR -REV	-		DIR	
Tipo valvola	F3	R/W	Type of valve : -Not selected. -ALCO EX5 -ALCO EX6 -ALCO EX7 -ALCO EX8 330 steps/s -SPORLAN 0.5-20tons -SPORLAN 25-30tons -SPORLAN 50-250tons -CAREL E2V**P	-			

			-CAREL E2V -DANFOSS ETS-25/50 -DANFOSS ETS-100 -DANFOSS ETS-250/400 -CUSTOM -ALCO EX8 500 steps/s				
Numero passi	F3	R	Number of steps	-			
Refrigerante	F3	R/W	Type of refrigerant: --- -R22 -R134a -R404a -R407c -R410a -R507c -R290 -R600 -R600a -R717 -R744 -R728 -R1270	-			
Passi minimi	F4	R/W	Minimum steps, custom valve	-	0 to 8100		
Passi massimi	F4	R/W	Minimum steps, custom valve	-	0 to 8100		
Passi chiusura	F4	R/W	Closing steps, custom valve	-	0 to 8100		
Extra apertura	F5	R/W	Extra opening, custom valve	-	Y/N		
Extra chiusura	F5	R/W	Extra closing, custom valve	-	Y/N		
Corrente fase	F6	R/W	Phase current custom valve	mA	0 to 1000		
Corrente staz.	F6	R/W	Holding current, custom valve	mA	0 to 1000		
Rateo passi	F7	R/W	Step rate, custom valve	Hz	32 to 501		
Duty-cicle	F7	R/W	Duty cycle, custom valve	%	0 to 100		
Passi Posizione EEV con rich.potenza 0%	F8	R/W	Steps in EEV standby	-	0 to number of steps (F3)		
Valore min.	F9	R/W	Minimum value, limit probe S1 Pressure probe limits	barg	-9.9 to +99.9		
Valore max	F9	R/W	Maximum value, limit probe S1 Pressure probe limits	barg	0 to 99.9		
Basso Sheat	Fa	R/W	Low superheat alarm delay	s	0 to 3600		
Alto Sheat	Fa	R/W	High superheat alarm delay	m	0 to 500		
LOP	Fb	R/W	LOP alarm delay	s	0 to 3600		
MOP	Fb	R/W	MOP alarm delay	s	0 to 3600		
Ritardo errore sonda	Fc	R/W	Probe error alarm delay	s	0 to 999		
Q1 to Q6 AUTOSETUP PARAMETERS							
ATTENZIONE Re-installare valori AUTOSETUP			Message for loading the AUTOSETUP default settings		Y/N		
Rapp.circuito/EEV per l'apertura all'accensione	Q1	R/W	Circuit/EEV ratio for opening on power-up	%	0 to 100		
Tipo comp.	Q2	R/W	Type of compressor : -Not selected -RECIPROCATING -SCREW -SCROLL -FLOODED CABINET -CABINET	-			
Controllo capacità	Q2	R/W	Type of capacity control: -Not selected -NONE or STEPS -CONTINUOUS SLOW -CONTINUOUS FAST	-			
Freddo	Q3	R/W	Type of evaporator (cooling) : -Not selected -PLATES -SHELL&TUBES -FAST FINNED -SLOW FINNED	-			
Caldo	Q3	R/W	Type of evaporator (heating) : -Not selected -PLATES -SHELL&TUBES -FAST FINNED	-			

-SLOW FINNED							
Mod.freddo	Q4	R/W	Minimum saturation temperature in cooling mode	°C	-70.0 to 50.0	-70.0	
Mod.caldo	Q4	R/W	Minimum saturation temperature in heating mode	°C	-70.0 to 50.0	-70.0	
Mod.defrost	Q4	R/W	Minimum saturation temperature in defrost mode	°C	-70.0 to 50.0	-70.0	
Mod.freddo	Q5	R/W	Maximum saturation temperature in cooling mode	°C	-50.0 to 90.0	-50.0	
Mod.caldo	Q5	R/W	Maximum saturation temperature in heating mode	°C	-50.0 to 90.0	-50.0	
Mod.defrost	Q5	R/W	Maximum saturation temperature in defrost mode	°C	-50.0 to 90.0	-50.0	
Alto SuperHeat soglia allarme	Q6	R	Automatic alarm threshold for high superheat	°C			
Alto SuperHeat soglia allarme	Q6	R/W	Manual alarm threshold for high superheat	°C	0.0 to 100.0	0.0	
N1 to N9 ADVANCED PARAMETERS							
Modifica parametri AUTOSETUP ?	-	R/W	Message to start the procedure for editing the AUTOSETUP settings PRG→Continue ESC→Back	-	-		
Circ./EEV Ratio Auto	N1	R	Circ./EEV ratio in automatic	%			
Circ./EEV Ratio	N1	R/W	Circ./EEV Ratio in manual	%	0 to 100		
Guadagno prop.Auto	N2	R	Proportional gain in automatic	-			
Guadagno prop.	N2	R/W	Proportional gain in manual	-			
Tempo integrale Auto	N2	R	Integral time in automatic	s			
Tempo integrale	N2	R/W	Integral time in manual	s	0 to 999		
Stp SuperHeat C1 Auto	N3	R	Superheat set point C1 in automatic	°C			
Stp SuperHeat C1	N3	R/W	Superheat set point C1 in manual	°C	0 to 50.0		
Basso SuperHeat Auto	N3	R	Low SuperHeat in automatic	°C			
Basso SuperHeat	N3	R/W	Low SuperHeat in manual	°C	-4.0 to 21.0		
Stp SuperHeat C2 Auto	N4	R	Superheat set point C1 in automatic	°C			
Stp SuperHeat C2	N4	R/W	Superheat set point C1 in manual	°C	0 to 50.0		
Basso SuperHeat Auto	N4	R	Low SuperHeat in automatic	°C			
Basso SuperHeat	N4	R/W	Low SuperHeat in manual	°C	-4.0 to 21.0		
Zona neutra SHeat Auto	N5	R	SuperHeat dead zone in automatic	°C			
Zona neutra SHeat	N5	R/W	SuperHeat dead zone in automatic	°C	0 to 9.9		
Tempo derivativo Auto	N5	R	Derivative time in automatic	s			
Tempo derivativo	N5	R/W	Derivative time in manual	s	0 to 99.9		
Basso tem.int.SH Auto	N6	R	Low SuperHeat integral time in automatic	s			
Basso tem.int.SH	N6	R/W	Low SuperHeat integral time in manual	s	0 to 30.0		
Tempo integrale LOP Auto	N6	R	LOP integral time in automatic	s			
Tempo integrale LOP	N6	R/W	LOP integral time in manual	s	0 to 25.5		
Tempo integrale MOP Auto	N7	R	MOP integral time in automatic	s			
Tempo integrale MOP	N7	R/W	MOP integral time in manual	s	0 to 25.5		
Ritardo MOP Auto	N7	R	MOP delay in automatic	s	0 to 50.0		
Ritardo MOP	N7	R/W	MOP delay in manual	s	0 to 50.0		
Guadagno proporzionale dinamico ?	N8	R/W	Select the type of proportional gain function	-	Y/N		
Attenz.blocco valv. Auto	N8	R	Warn. valve lock in automatic	s			
Attenz.blocco valv.	N8	R/W	Warn. valve lock in manual	s	0 to 99.9		
Prot. Alta TCond. Auto	N9	R	High condensing temperature protection in automatic	°C			
Prot. Alta TCond. Auto	N9	R/W	High condensing temperature protection in manual	°C	0 to 99.9		
Tempo int.alta Tcond Auto	N9	R	High condensing temperature integral time in automatic	s			
Tempo int.alta Tcond Auto	N9	R/W	High condensing temperature integral time in manual	s	0 to 25.5		









8. Screens

The application program user interface includes screens that are freely displayable, while others, for security reasons, are password-protected.

There are different levels of security between the screens:

- Screens that are not password-protected: these are located in all the branches, except for MANUFACTURER and USER, and show the values read by the probes, the status of the alarms, the operating hours of the devices, the time and date; they are also used to set the set point and the clock. These screens are indicated by the symbol "1" in the following table.
- Password-protected sub-screens (represented in the table by the symbol "2"): in the SERVICE and CLOCK branches there are free screens, not password-protected, followed by a password screen to access further sub-screens. These are used to control the devices, calibrate the probes, modify the operating hours, manually manage the devices and set the time bands.
- Password-protected screens (represented in the table by the symbol "3"): these are in the MANUFACTURER and USER branches and are used to configure the unit, enable the main functions and select the devices connected.

The columns in the table represent the groups of screens, with the first screen (A0, S0 etc.) being the one that is displayed when pressing the corresponding button (or, for the display with 6 buttons, accessible from the main menu), after which the arrow buttons can be used to scroll the other screens. The codes (Ax, Bx, Cx etc.) are displayed in the top right corner of the screens, making them easy to identify. The annotation PSW indicates screens that are protected by password.

						 + 
① M0	① A0	① I0	① K0	① S0	PSW P0	PSW Z0
① M1	① A1	① I1	PSW K1	① S1	③ P1	MANUFACTURER MENU Z1
① M2	① A2	① I2	② K2	① S2	③ P2	CONF. → ③ C0
① M3	① A3	① I3	② K3	① S3	③ P3	③ C1
	① A4	① I4	② K4	① S4	③ P4	③ C2
	① A5	① I5	② K5	① S5	③ P5	③ C3
	PSW A6	① I6	② K6		③ P6	③ C4
	② A7	① I7	② K7		③ P7	③ C5
	② A8	① I8	② K8		③ P8	③ C6
	② A9	① I9			③ P9	③ C7
	② Aa	① Ia			③ Pa	③ C8
	② Ab	① Ib			③ Pb	③ C9
	② Ac	① Ic			③ Pc	③ Ca
	② Ad	① Id			③ Pd	③ Cb
	② Ae	① Ie			③ Pe	③ Cc
	② Af	① If			③ Pf	③ Cd
	② Ag	① Ig			③ Pg	③ Ce
	② Ah	① Ih			③ Ph	③ Cf
	② Ai	① Ii			③ Pi	③ Cg
	② Aj	① Ij			③ Pj	③ Ch
	② Ak	① Ik			③ Pk	③ Ci
	② Al	① Il			③ Pl	③ Cj
	② Am	① Im			③ Pm	③ Ck
	② An	① In			③ Pn	③ Cl
	② Ao	① Io			③ Po	③ Cm
	② Ap	① Ip			③ Pp	PARAM. → ③ G0
	② Aq	① Iq			③ Pq	③ G1
	② Ar	① Ir			③ Pr	③ G2
	② As				③ Ps	③ G3
	② At				③ Pt	③ G4
	② Au				③ Pu	③ G5
	② Av				③ Pv	③ G6
	② Aw					③ G7
						③ G9
						③ Ga
						③ Gb
						③ Gc
						TIMES → ③ T0
						③ T1
						③ T2
						③ T3
						③ T4
						③ T5
						③ T6
						INITIAL. → ③ V0
						③ V1

EXV	Manufacturer	Autosetup	Advanced
MENU	④ F1	④ Q1	④ N1
	④ F2	④ Q2	④ N2
	④ F3	④ Q3	④ N3
	④ F4	④ Q4	④ N4
	④ F5	④ Q5	④ N5
	④ F6	④ Q6	④ N6
	④ F7		④ N7
	④ F8		④ N8
	④ F9		④ N9
	④ Fa		
	④ Fb		
	④ Fc		

9. EVD400 electronic expansion valve

The EVDriver module for the control of electronic expansion valves (EEV) in pLAN (or tLAN) networks allows superheat control on the suction side for more efficient and versatile operation of the refrigeration unit.

Efficient because the optimisation and stabilisation of the flow of refrigerant to the evaporator increases the overall performance of the installation, at the same time guaranteeing the safety (less activations of the low pressure switch, less return of liquid refrigerant to the compressor,...). In addition, if the EEV is correctly sized, the use of floating condensing (and evaporation) pressure or a low set point significantly increases the efficiency of the installation, guaranteeing lower energy consumption, with higher cooling efficiency. Versatile because the electronic expansion valve allows the use of compressors with different capacities and operating in different conditions.

The use of an expansion valve requires the installation not only of the EVDriver and the expansion valve, but also of a temperature sensor and a pressure transducer, both fitted at the end of the evaporator on the refrigerant side (on the compressor intake pipe). See the diagram below to better understand the typical layout of the installation. The priorities to be considered for the optimum control of the refrigeration system involve achieving a high and constant refrigerating efficiency, as well as low and stable superheat values. The heart of the control system is a PID control algorithm, with settable superheat coefficients.

The following values can be set:

- LOW (Low superheat with programmable integral time and threshold)
- LOP (Low evaporation pressure, operating only in transients, with programmable integral time and threshold)
- MOP (High evaporation pressure, with programmable integral time and threshold)
- HiTcond (High condensing pressure, activated with condensing pressure probe read by pCO, with programmable integral time and threshold)

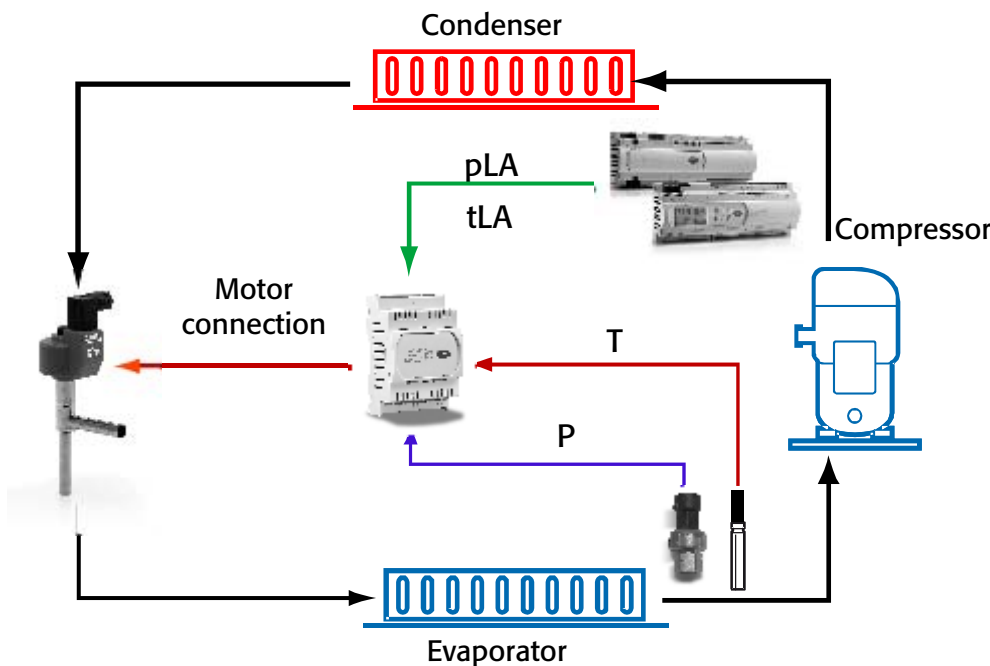

9.1 Configuring the EVD400

The EVD400 driver can be controlled in pLAN or tLAN mode.

One EVD400 driver is used for each refrigerant circuit set, operation is bi-directional. The same driver ensures control in both cooling and heating mode.

The number of drivers enabled depends on the number of circuits set.

For the settings of the parameters and the address of the EVD400, see the technical manual (Carel code +030220225).

10. Ambient air temperature control

Ambient temperature control is performed by activating the connected devices (compressors, heaters, valves and dampers). The user can set two control set points, one for cooling operation and one for heating operation. The activation of the compressors can be managed with two types of control:

- proportional control (P);
- proportional + integral control (P+I).

10.1 Cooling/Heating changeover

Inputs used:

- Ambient air temperature probe
- Cooling/heating selection (digital input)

Parameters used:

- Cooling set point (S0)
- Heating set point (S1)
- Cooling/heating changeover selection (C6)

Description of operation:

The operating mode is selected performs on screen C6, manufacturer branch, password-protected.

The operating mode can be changed between cooling and heating in the following ways:

Control panel mode:

- 15-button terminal: to enter the desired operating mode, press the corresponding button; red button for heating operation, blue button for cooling operation;
- terminal with 6 buttons: PRG button to enter the main menu; select Cooling/Heating and press ENTER; on this screen, each time ENTER is pressed the mode switches from cooling to heating and vice-versa.

Digital input mode:

contact open: cooling operation.

contact closed: heating operation.

Automatic mode:

the unit switches from cooling operation to heating operation or vice-versa based on the ambient air temperature.

$T_{Amb} > \text{Cooling set point} \Rightarrow \text{Cooling operation.}$

$T_{Amb} < \text{Heating set point} \Rightarrow \text{Heating operation.}$

10.2 Unit ON/OFF

Inputs used:

Digital remote on/off input (not available on the pCO⁵).

Parameters used:

Enable automatic restart after a blackout (Pp);

Enable weekly time bands (K6);

Enable remote ON/OFF (Pp) (not available on the pCO⁵).

Description of operation:

The unit can be switched on or off in the following modes:

- from the panel using the ON/OFF button (15-button terminal) or on a screen accessible from the main menu, UNIT ON/OFF (terminal with 6 buttons);
- from the remote ON/OFF digital input;
- based on unit On/Off weekly time bands;
- from the supervisor (if connected).

10.2.1 ON/OFF by button:

1. 15-button terminal: the on-off button on the front panel can be used to switch the unit on or off.
2. Terminal with 6 buttons: from the main menu select UNIT ON/OFF and press ENTER; each time ENTER is pressed the unit switches from on to off and vice-versa. If the unit has been switched off from the panel, it cannot be activated with any of the other procedures (digital input, time bands, supervisor). If the unit is off, all the functions and controls are disabled.

10.2.2 Remote ON/OFF: (not featured on pCOXS boards)

The unit switches on if are the following conditions are true:

- the unit is switched on from the panel;
- the digital input contact is closed.

The unit switches off if one of the following conditions is true:

- the unit is switched off from the panel;
- the digital input contact is open.

10.2.3 ON/OFF by time bands:

The unit switches on if are the following conditions are true:
the unit is switched on from the panel;
the unit is activated by digital input (if enabled)
the unit is fitted with the clock board;
the time band is active.

The unit switches off if one of the following conditions is true:
the unit is switched off from the panel;
the unit is deactivated by digital input (if enabled)
the time band is inactive.

10.2.4 ON/OFF from supervisor (and GSM)

The unit can be switched on/off from the supervisor (see the supervisor table) if the following conditions are true:

the unit is switched on from the panel;
the unit is activated by digital input (if enabled)
the time band is active (if enabled)
the logical status of the supervisor digital variable is 1

The unit switches off if one of the following conditions is true:

the unit is switched off from the panel;
the unit is deactivated by digital input (if enabled)
the time band is inactive (if enabled)
the logical status of the supervisor digital variable is 0

10.3 Compressor control

The compressors are managed as ON/OFF loads (hermetic and semi-hermetic compressors).

Up to 4 loads can be controlled (heating or cooling steps), in the combinations listed below:

Setting	No. circuits	No. comps. C1	No. steps C1	No. comps. C2	No. steps C2
1 COMP	1	1	0	0	0
1 COMP+1 STEP	1	1	1	0	0
2 COMPS	1	2	0	0	0
2 COMPS	2	1	0	1	0
2 COMPS+2 STEPS	1	2	2	0	0
2 COMPS+2 STEPS	2	1	1	1	1
4 COMPS	2	2	0	2	0

10.4 Load steps

These can have N.O. (normally open relay) or N.C. (normally closed relay) logic. They are activated with a settable delay from when the compressors are started (T6).

If dehumidification is required, the maximum number of compressors to be activated can be set (1-4). The activation of the compressors and any load steps will be based on the dehumidification requirement.

Inputs used:

ambient temperature probe.

Parameters used:

cooling set point (S0);
heating set point (S1);
cooling control band (P4);
heating control band (P4);
cooling control dead zone (P4);
number of compressors selected (C0);
enable heat pump (C1);
select proportional / proportional + integral control (G0);
integral time (G0);
enable compressor 1-2 (P1);
enable compressor 3-4 (P2).

Description of operation:

The compressors are activated according to the ambient air temperature.

The compressors must be enabled on screens "P1 – P2" in the user branch.

10.4.1 Operation with 1 compressor

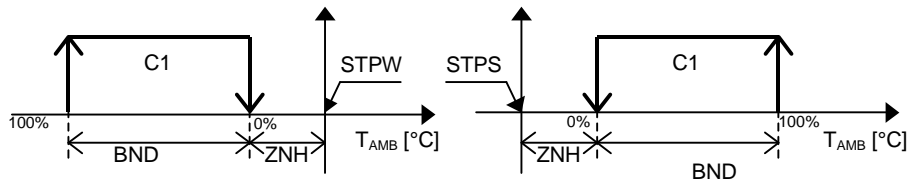

10.4.2 Operation with 1 compressor + 1 load step

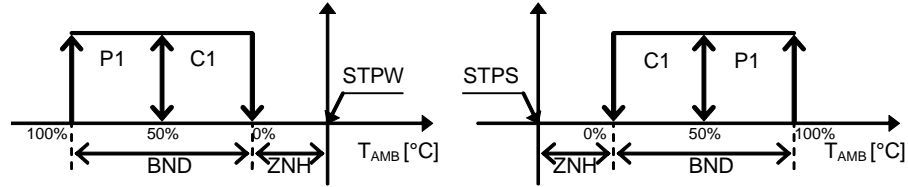

10.4.3 Operation with 2 compressors

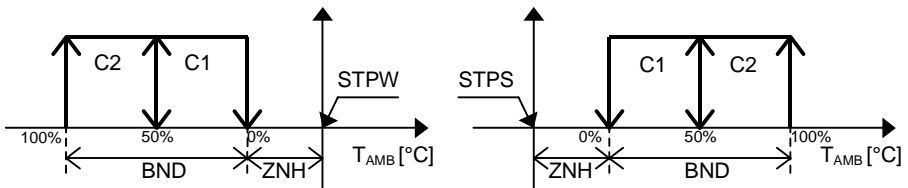

10.4.4 Operation 2 compressors + 2 load steps

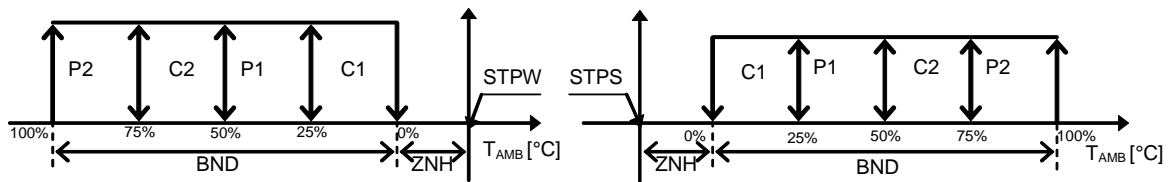

10.4.5 Operation with 4 compressors

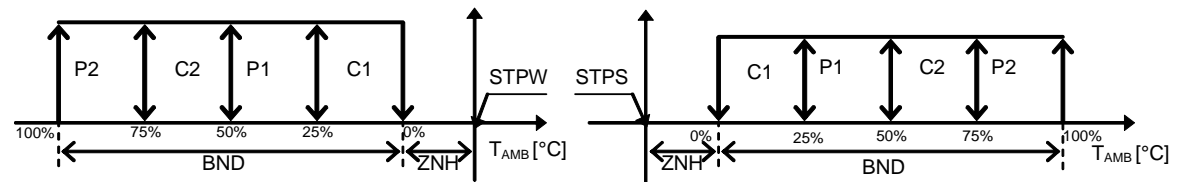

- STPW Heating set point [°C]
- STPS Cooling set point [°C]
- ZNH Dead zone/2 [°C]
- BND Control band [°C]
- TAMB Ambient temperature [°C]
- C1 Compressor 1
- C2 Compressor 2
- P1 Compressor 1 capacity-control
- P2 Compressor 2 capacity-control

10.4.6 Proportional or Proportional + Integral operation

The type of control is selected on screen G0.

Proportional:

An ideal ambient air temperature set point is defined, and the controller will operate so as to bring the system as near as possible to the set point, proportionally to the deviation of the system from such set point. A proportional band is defined around to the set point (P4), in which the controller applies the minimum action in relation to the set point (S0,S1), then as the controlled value moves away from this band the action of the controller will increase until reaching saturation, that is, the extreme limits of control and consequently maximum capacity.

Proportional + Integral:

In addition to the proportional control action described above, proportional + integral control introduces the concept of "time". The defining parameter is the time constant, expressed in seconds, which represents the P+I response speed (low times = high speed). This useful to avoid situations of "stalemate" (the set point cannot be reached) that is typical of proportional-only control.

10.4.7 Compressor rotation

The rotation of the compressors can be enabled on screen C1.

Compressor rotation follows F.I.F.O. logic (first in-first out). The objective is to try to balance the operating hours of the compressors so that they all have approximately the same age.

10.4.8 Balancing capacity

The balancing of capacity can be enabled on screen C1.

If the capacity balancing feature is enabled, the controller activates equal steps in both circuits (if configured).

This means that when compressor 1 is started in circuit 1, this will be followed by compressor 1 in circuit 2.

Below is compressor activation sequence (excluded if rotation is enabled):

Capacity balancing enabled

1. Compressor 1 circuit 1
2. Compressor 1 circuit 2
3. Compressor 2 circuit 1
4. Compressor 2 circuit 2

Capacity balancing disabled

1. Compressor 1 circuit 1
2. Compressor 2 circuit 1
3. Compressor 1 circuit 2
4. Compressor 2 circuit 2

10.4.9 Compressor times

Time between the activation of the main fan and the first compressor

This represents the minimum time that must elapse between the start of the main fan and the first compressor.

Minimum on time

Sets the minimum operating time (in seconds) of the compressors when they have been activated. Even if called to stop, they can only be deactivated after this time has elapsed.

Minimum off time

Sets the minimum off time (in seconds) of the compressors when they have been stopped. Even if called to start, they can only be activated after this time has elapsed.

Minimum time between starts of different compressors

This represents the minimum time (in seconds) that must elapse between one device activation and the next. This time is used to avoid simultaneous starts that would cause high power consumption.

Minimum time between starts of the same compressor

This establishes the minimum time (in seconds) that must elapse between two starts of the same device. This parameter is used to limit the number of starts per hour. If, for example, the maximum number of starts / hour allowed by the manufacturer is 10, simply set a time of 360 seconds to ensure this limit is observed.

10.5 Defrost

Inputs used:

Defrost probe 1;
Defrost probe 2.

Devices used:

Reversing solenoid valve 1;
Reversing solenoid valve 2;
Compressor no. 1;
Compressor no. 2.

Parameters used:

Type of defrost probe (C3);
Start defrost set point (G3);
End defrost set point (G3);
Defrost start delay (Pn);
Maximum defrost time (Pn);
Compressor off time at start and end defrost (T5);
Enable main fan shutdown (G4);
Enable simultaneous defrosting the circuits (G4);
Select simultaneous defrost mode (G5).

There are two defrost modes.

10.5.1 Non-simultaneous defrost

The 2 circuits are never defrosted at the same time. If the defrost call is active on both circuits, one of the two circuits starts the defrost procedure, while the other remains in standby.

The defrost procedure is activated if the following conditions are true:

- the unit is in heating operation;
- the defrost temperature probe reads a value less than the "start defrost set point" (G3) for a total time equal to the "defrost delay time" (Pn);
- the compressors are on.

The defrost can end in two ways:

- by temperature, if the defrost temperature probe reads a value higher than the "end defrost set point" (G3);
- after a maximum time, if the defrost temperature probe does not reach the end defrost set point within the "maximum defrost time" (Pn).

10.5.2 Simultaneous defrost

This can be divided into:

- simultaneous defrost with simultaneous end;
- simultaneous defrost with non-simultaneous end.

In both cases the activation of the defrost on the 2 circuits depends on the probe with the lower temperature reading.

The end of the defrost, on the other hand, is differentiated.

If the defrost is configured with simultaneous end, the defrost will terminate on both circuits when the first of the two probes measures a value higher than the end defrost set point.

If the defrost is configured with non-simultaneous end, on the other hand, the defrost will terminate separately on each circuit when the corresponding probe measures a value higher than the end defrost set point.

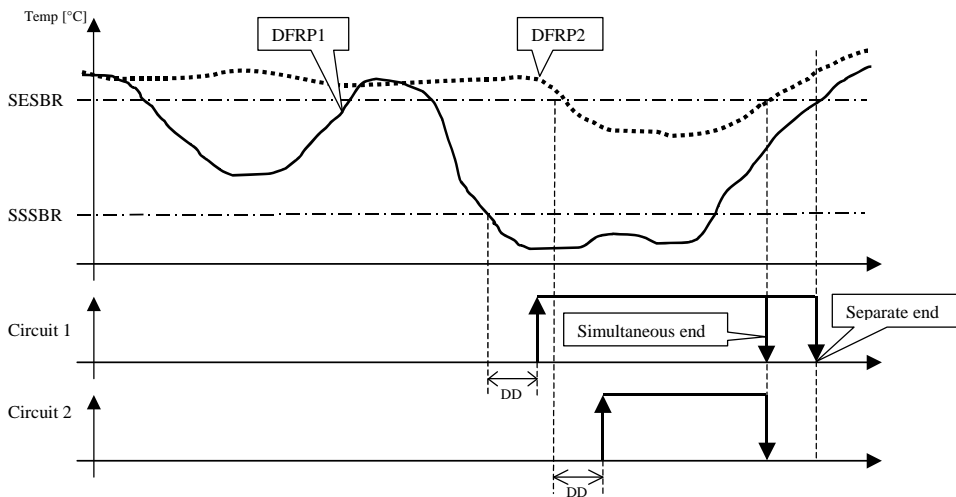

DFRP1	Defrost probe circuit 1 [°C]
DFRP2	Defrost probe circuit 2 [°C]
SESBR	End defrost threshold [°C]
SSSBR	Start defrost threshold [°C]
DD	Defrost delay [s]

The simultaneous defrost can also end after a maximum time if the defrost temperature probe does not reach the end defrost set point within the "maximum defrost time" (Pn).

In both modes, the compressor off time at start and end defrost can be set.

This time allows the cycle to be reversed with the compressors off.

As soon as the defrost call is activated, the compressors stop and after few seconds the refrigeration cycle is reversed; the compressors remain off for the set time.

If the time is set to zero seconds, the compressor shutdown function is automatically disabled.

NB: the main fan can also be set to stop operation during the defrost procedure (G4).

10.6 Reversing solenoid valves

Devices used:

Reversing solenoid valve 1
Reversing solenoid valve 2

Parameters used:

Reversing valve logic

The operating logic of the four-way reversing valves can be set on the corresponding screen (C1).

The operating logic can be set as NC (normally closed) or NO (Normally open).

10.6.1 Reversing valve status

The following table shows the status of the reversing valves based on the logic of the digital outputs (N.O. – N.C.) and the operating mode.

Operating mode	N.C.		N.O.	
	DOUT12 (valve 1)	DOUT13 (valve 2)	DOUT12 (valve 1)	DOUT13 (valve 2)
Cooling (Unit ON)	Contact closed (1)	Contact closed (1)	Contact open (0)	Contact open (0)
Cooling (Unit OFF)	Contact open (0)	Contact open (0)	Contact open (0)	Contact open (0)
Heating (Unit ON)	Contact open (0)	Contact open (0)	Contact closed (1)	Contact closed (1)
Heating (Unit OFF)	Contact open (0)	Contact open (0)	Contact open (0)	Contact open (0)

10.7 Main fan

Inputs used:

Interlock digital input/main fan thermal overload.

Devices used:

Main fan.

Parameters used:

Main fan off delay (T4)

Fan off in defrost (G4)

Fan off from time band (K2)

The main fan is the device that starts first after the unit has been switched on. After the unit has stopped the main fan will remain on, even in the event of air flow alarms, for a set time. (T4).

The main fan can be forced off in the following cases:

- during the defrost (G4);
- when the unit is started based on daily time bands (K2).

The main fan can be activated by the digital output test procedure (screen An) if there are no alarms that disable it.

10.8 Condenser fans

Inputs used:

Defrost/condenser temperature probe 1

Defrost/condenser temperature probe 2

Devices used:

Condenser fan 1

Condenser fan 2

Parameters used:

Enable defrost/condenser probe 1 (Cg)

Enable defrost/condenser probe 2 (Ci)

Control (C3)

Type of control (C3)

Condenser fan set point (G7)

Condenser fan differential (G7)

Inverter speed limits (G9)

Minimum on time (G9)

Enable prevent (Ga)

Prevent set point (Ga)

Prevent differential (Ga)

Prevent output delay (Ga)

Coupled operation of the fans (Gb)

Description of operation:

If the defrost/condenser probes are not enabled, the fans will operate as follows:

- Compressor On => Fan On
- Compressor Off => Fan Off
- Defrost On => Fan Off

If the defrost/condenser probes are enabled, the operation of the fans is determined by the "Control" and "Type of control" parameters (C3). The following possibilities are available

Control	Compressor	By pressure	By temperature	By pressure	By temperature
Type of control	-	On/Off	On/Off	Modulating	Modulating
Operation	a)	b)		c)	

- a) Control based on compressor: similar to operation with the probes disabled
- b) On/Off control by pressure/temperature: if at least 1 of the compressors in the circuit is ON, the fan digital output closes at the set+diff in cooling and set-diff in heating.

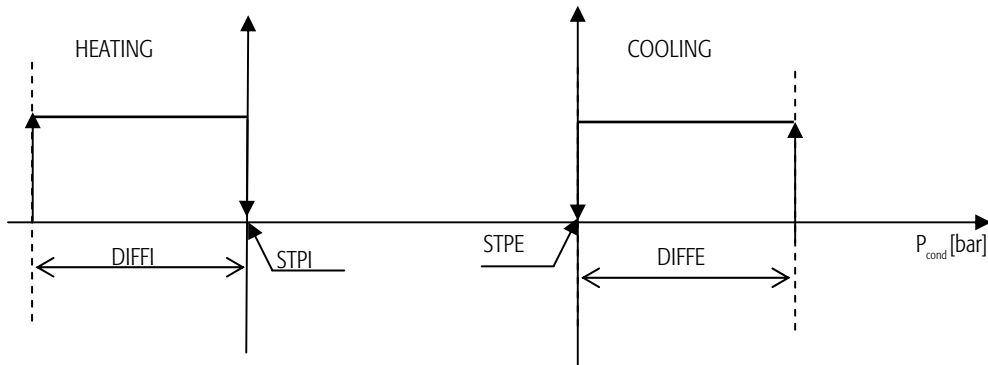

STP Cond. temp. set point [°C]
 DIF Cond. temp. differential [°C]
 TCND1 Condensing temperature 1 [°C]
 TCND2 Condensing temperature 2 [°C]

- c) Modulating control by pressure/temperature: when the condensing pressure/temperature is higher (lower) than the set point, the digital output is activated and the condenser control analogue output starts modulating.

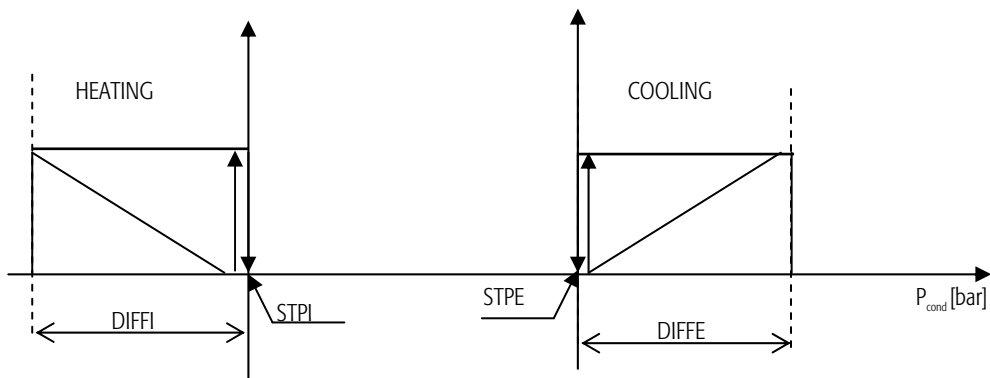

STP Cond. temp. set point [°C]
 DIF Cond. temp. differential [°C]
 TCND1 Condensing temperature 1 [°C]
 TCND2 Condensing temperature 2 [°C]

Two further options are also featured:

- separate operation: each of the two fans is controlled according to its own condensing temperature.
- coupled operation: both fans are controlled based on the higher of the condensing temperatures in cooling, and the lower of the two in heating.

10.9 Freecooling control and freeheating by temperature

The operation of the unit in FREECOOLING or FREEHEATING mode is used to exploit the outside air when the temperature conditions are favourable with reference to the ambient air. The operation of the unit in freecooling mode in heating/cooling operation or in freeheating mode in heating operation can be selected by password-protected parameter in the manufacturer branch (C1).

Inputs used:

Outside air temperature probe
Ambient air temperature probe

Devices used:

0 to 10 V outside damper

Parameters used:

Freecooling/heating differential by temperature (C5)
Freecooling/heating differential by enthalpy (C5)
Freecooling offset in cooling (Pj)
Modulating freecooling differential in cooling (Pi)
Freeheating offset in heating (Pk)
Modulating freeheating differential in heating (Pk)
Temperature control set point (S0, S1)
Temperature control band (P4)
Minimum damper opening (PI)
Enable force freecooling when starting the unit (PI)
Freecooling forcing time (Po)
Enable control (temperature/ temperature-humidity) during the forced operation (Po)

10.9.1 Freecooling in cooling mode

The opening of the outside damper is controlled based on the ambient air temperature, as shown in the following figure, if the following conditions are always true: the unit is in cooling operation; the outside temperature probe is enabled on screen, C8, manufacturer branch, password-protected; the freecooling function in cooling is enabled on screen, C4, manufacturer branch, password-protected; the (outside temperature) < (ambient temperature - freecooling differential Pi); ambient temperature > cooling set point + offset (see the figure).

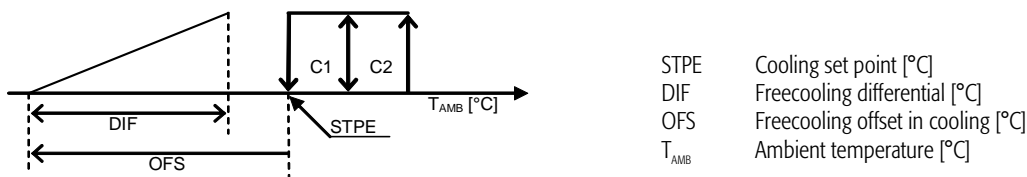

If a positive offset is set, freecooling can start after the set point.

10.9.2 Freeheating in heating mode

The opening of the outside damper is controlled based on the ambient air temperature, as shown in the following figure, if the following conditions are always true: the unit is in heating operation; the outside temperature probe is enabled on screen C8, manufacturer branch, password-protected; the freeheating function in heating is enabled on screen C4, manufacturer branch, password-protected; (outside temperature - ambient temperature) > (freeheating differential Pk); ambient temperature < heating set point + offset (see figure)

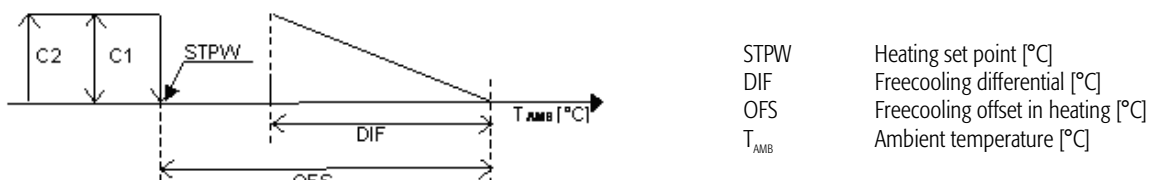

The "offset" and "differential" parameters for controlling the opening of the damper can be set on screen PI, user branch, password-protected.

For freeheating to be enabled, the condition "outside temperature - ambient temperature > freeheating differential" must be satisfied. The damper is 100% open when the ambient temperature is less than the "(Set point + Offset)-differential". It starts modulating, from 100% to 0%, when the ambient temperature increases from "(Set point + Offset)-differential" to "Set point + offset". When the temperature is higher than "Set point + offset" the damper is completely closed.

If a negative offset is set, freeheating can be started before the set point.

10.9.3 Freecooling in heating mode

Freecooling in heating mode is useful when the environment is overcrowded (for example, in shopping centres) during operation in heating mode. In these situations, the temperature is always higher than the set point and there is the need to cool the environment, in which case the outside temperature conditions are exploited, as in winter these almost always favourable.

The opening of the outside damper is controlled based on the ambient air temperature, as shown in the figure below, if the following conditions are always true:

- the unit is in heating operation;
- the outside temperature probe is enabled on screen C8, manufacturer branch, password-protected;
- the freecooling function in heating is enabled on screen C4, manufacturer branch, password-protected;

- the (outside temperature) < (ambient temperature - freecooling differential).

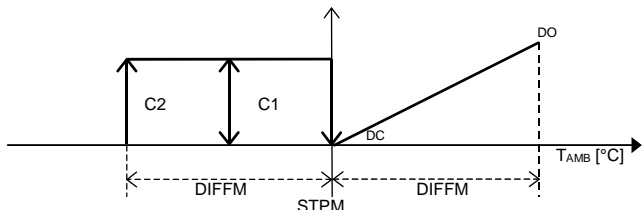

STPM	Control set point [°C]
DIFFM	Control differential [°C]
T _{AMB}	Ambient temperature [°C]
DC	Damper closed
DO	Damper open

The set point and the differential (also considering the dead zone/2) are the same as used in heating operation. In FREECOOLING IN COOLING MODE and FREEHEATING IN HEATING MODE, the outside damper (normally closed), starts mixing outside air with the ambient air, thus trying to bring the temperature as close as possible to the set point, switching off as many cooling or heating devices as possible. The ideal condition would be for the desired temperature or enthalpy to be reached by only modulating the damper. The minimum opening of the damper can set, if the unit is on, from screen Pl. If heating operation and with the "damper at start-up in heating" (Pl) parameter set to "closed", when starting or after a blackout the damper remains completely closed until the control temperature reaches the set point. If this parameter is set to "normal", the above described function is not run. In the outlet limit is active, the modulation of the damper is disabled, and it is forced closed.

10.9.4 Forced freecooling (ambient cleaning)

The freecooling damper (cooling/heating) can be opened when the unit is started to ensure the complete renewal of the air in the environment. The parameter on screen "Pm" is used to enable the function, while screen "Po" sets the time the outside damper is forced open. This procedure opens the damper 100% for the set time. During this period, the other devices such as compressors, heaters, heating valve etc. can be enabled or disabled for normal control (Po). The forcing procedure can be terminated by pressing the ENTER button from the main screen (M0). During forced operation on screen M3, the status is displayed, indicated by "FORCED"; the main screen shows the message flashing "ENTER→STOP" to terminate the procedure. If the forcing procedure is not stopped manually, it will end after the time set on screen "Po".

10.9.5 Force freecooling from CO2 probe

This function is only available on the pCO3 board.

Inputs used

- CO2 probe

Devices used

- Outside air damper

Parameters used

- Enable air quality control (Ce)
- Select type of air quality probe (Ce)
- Air quality control set point (Pg)
- Air quality control differential (Pg)
- Air quality control dead zone (Pg)

Description of operation

If the CO2 probe is enabled and the unit is ON, based on the CO2 conditions the outside air damper will be opened to introduce air that is normally cleaner (fresher). The request (see the graph) to the open damper due to a high CO2 level, is summed to the normal temperature control request.

Air quality control graph

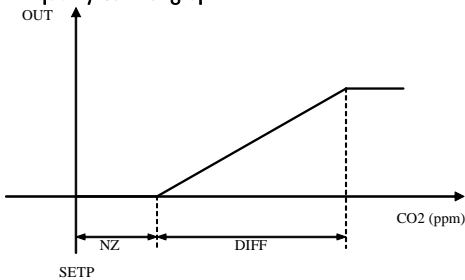

SETP	Control set point air quality (ppm)
DIFF	Control differential air quality (ppm)
NZ	Control dead zone air quality
CO2	CO2 probe reading [ppm]
OUT	Outside air damper modulating output

10.9.6 Freecooling damper forced off at start-up

This function is only available in winter and it is used for to have the room temperature on the setpoint quickly at the unit start-up.

Inputs used:

- Ambient air temperature probe

Devices used

- Outside air damper

Parameters used

- Temperature control set point (S1)
- Enable force freecooling when starting the unit (Pl)

In winter, at the start-up of the unit, if this function is enabled, freecooling outside air damper will be forced off. It is closed totally, not works on the minimum opening value. The damper can start regulating after that the ambient temperature is greater than the setpoint for at list one time.

10.10 Heating valve control

Control of a 0/10V modulating valve.

Inputs used:

Ambient temperature probe.

Outlet temperature probe.

Outputs used:

Digital output NO17 (pCO3-Large board only)

Devices used:

Heating valve.

Parameters used:

Enable heating valve (C2).

Set type of heating (C2)

Enable heating in summer (Cr).

Valve open temperature offset (Pf).

Valve closed temperature differential (Pf).

Outlet temperature set point for antifreeze function (PB)

Supply temperature differential for antifreeze function (PB)

Maximum opening % of the valve during antifreeze (PC)

Description of operation:

The heating valve is controlled based on the ambient temperature, as shown in the figure below, if the following conditions are always true:

The unit is in heating operation, or in summer if the heating in summer is enable, or if post-heating during dehumidification is enable;

or enable heating in summer;

heating valve control is enabled on screen C2, manufacturer branch, password-protected;

Heating valve or heater&heating valve is selected on screen Cr, manufacturer branch, password-protected.

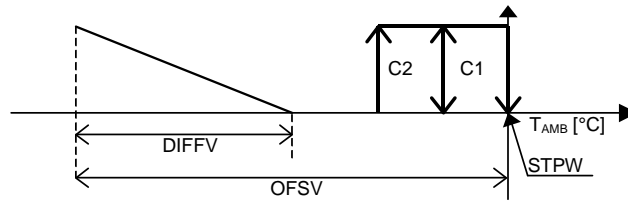

STPW	Heating set point [°C]
DIFFV	Control differential heating valve [°C]
T_{AMB}	Ambient temperature [°C]
OFSV	Valve open temperature offset [°C]

Enabling the outlet temperature probe (C9) automatically enables antifreeze control, which involves opening the valve when the unit is off. When the outlet temperature is less than the antifreeze set point, set on screen PB, the heating valve is progressively opened. When the outlet temperature reached the antifreeze set point-differential (PB), the valve will be open to the percentage set on screen PC. On a graph:

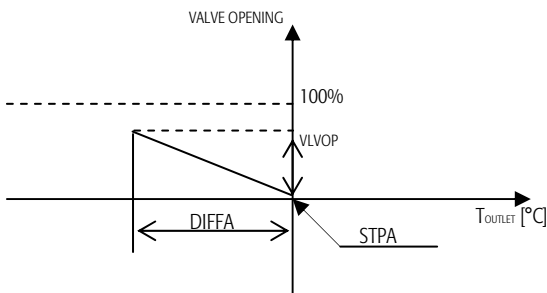

STPA	Antifreeze control outlet temperature set point [°C]
DIFFFA	Antifreeze control outlet temperature differential [°C]
VLVOP	Heating valve opening during antifreeze operation (unit Off) [%]

If the outlet temperature falls below the antifreeze set point during normal heating operation with the unit on, the opening of the valve for the antifreeze function is summed to the request in normal operation.

For the pCO3 Large board only, digital output 17 is available, which indicates the operating status of the valve (On/Off) and can be used to activate a water circulating pump in the heating coil.

10.11 Outlet temperature limit

The outlet temperature is controlled within the operating limits.

In cooling operation, the minimum limit is controlled, while in heating operation the maximum limit is controlled.

Inputs used:

Outlet temperature probe

Devices used:

Compressor 1-4

Outside damper.

Heating valve

Electric heaters

Parameters used:

Enable outlet probe (C9)

Set type of outlet probe (C9)

Minimum outlet temperature limit set point (P7)

Minimum outlet temperature limit differential (P7)

Maximum outlet temperature limit set point (PA)

Maximum outlet temperature limit differential (PA)

Description of operation:

Minimum limit in cooling operation

When the outlet temperature falls below the minimum limit set point plus the differential (P7), the minimum outlet temperature limit function is activated, which involves the following actions:

- Close the outside damper
- Shutdown the compressors

The compressors are shutdown proportionally to the value of the outlet temperature compared to the minimum limit differential set. As the outlet temperature decreases, all the compressors configured and operating will be shut down, within the minimum limit differential interval. Consequently, when the outlet temperature falls below the minimum limit set point, all the compressors will be off.

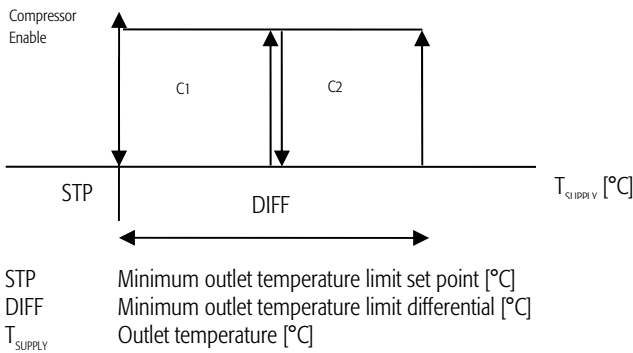

Maximum limit in heating operation

When the outlet temperature rises above the maximum set point limit minus the differential (PA), the maximum outlet temperature limit function is activated, which involves the following actions:

- Close the outside damper
- Shutdown the compressors
- Close the heating valve
- Shutdown the electric heaters

The compressors are shutdown proportionally to the value of the outlet temperature compared to the maximum limit differential set. As the outlet temperature increases, all the compressors configured and operating will be shut down, within the maximum limit differential interval. Consequently, when the outlet temperature rises above the maximum limit set point, all the compressors will be off.

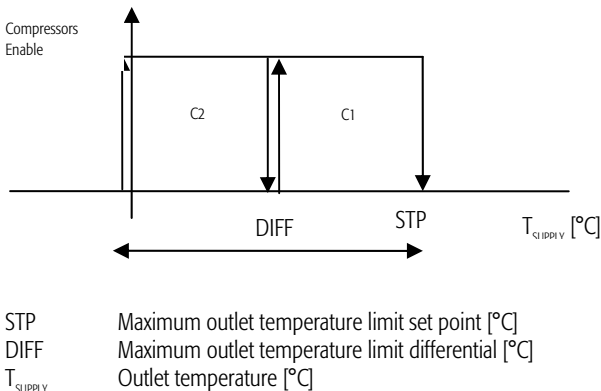

10.12 Heaters control

On one hand, heaters can be activated for heating directly if the heating valve is not enabled. On the other hand, it can be activated when the heat pump or the heating valve are not sufficient to heat the ambient air as required.

Inputs used:

Ambient air temperature.

Devices used:

Heater no. 1.

Heater no. 2.

Parameters used:

Number of heaters set (C2).

Set type of heating (C2)

Enable heating in summer (Cr).

Heater control offset (Pf).

Heater control differential (Pf).

Temperature control set point (S0/S1).

Enable heater 1 (Pd).

Enable heater 2 (Pd).

Description of operation

The auxiliary heaters are controlled based on the ambient air temperature, as shown in the figure below, if the following conditions are always true:

- the unit is in heating operation, or in summer if the heating in summer is enable, or if post-heating during dehumidification is enable;
- more than 0 heaters are set on screen (C2), manufacturer branch, password-protected;
- heater or heater&heating valve is selected on screen (C2), manufacturer branch, password-protected.
- heater 1 and 2 are enabled on screen (Pd) user branch, password-protected.

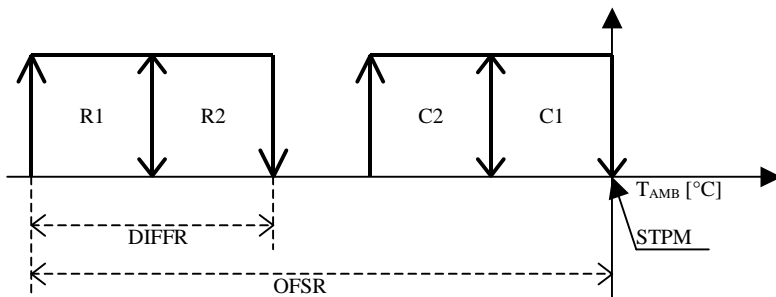

STPM	Control set point [°C]
OFSR	Heater control offset [°C]
DIFFR	Heater control differential [°C]
T _{AMB}	Ambient temperature [°C]

10.13 Notes on the relationship between the offset and differential settings for the heating devices and their activation sequence

A relationship exists between the offsets and the differentials for the heating valve and heaters and the compressor control band in heating operation. In fact, once the compressor control band has been set, the heating valve and heater offsets and differentials correspond to the selection of their activation sequence and overlapping. The default values assigned by the application to these parameters represent the following activation sequence:

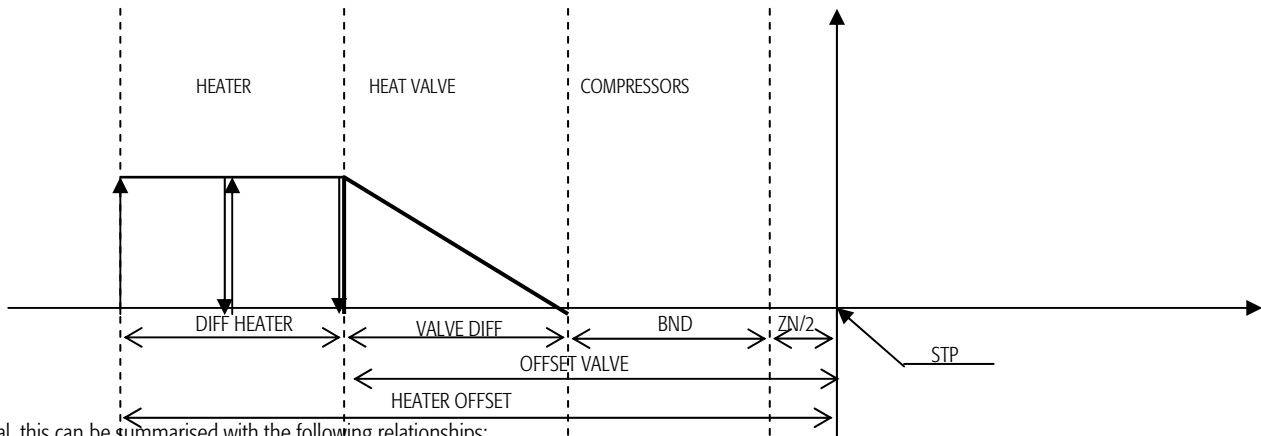

In general, this can be summarised with the following relationships:

If $(\text{VALVE_OFFSET}) - (\text{VALVE_DIFF}) = \text{BND} + \text{ZN}/2$, then the valve will start opening when the last compressor step is activated

If $(\text{VALVE_OFFSET}) - (\text{VALVE_DIFF}) < \text{BND} + \text{ZN}/2$, then the valve will start opening within the compressor control band (Figure 2)

If $(\text{VALVE_OFFSET}) - (\text{VALVE_DIFF}) > \text{BND} + \text{ZN}/2$, then the valve will start opening after the last compressor step has been activated.

The same rules are also valid for the activation of the heaters with reference to the heating valve. To reverse the activation of the valve and the heaters, remember that the device with the highest offset is the one that is activated last.

Example 1)

Configuration	1 Comp.	Heating valve	1 Aux. heater				
Parameters	STP = 21 °C	ZN/2 = 1 °C	BND = 3 °C	VALVE_OFFSET = 5	VALVE_DIFF = 2	HEAT_OFFSET = 6	HEAT_DIFF = 2

At the temperature of $21 - 1 - 3 = 17$ °C the compressor is started

At the temperature of $21 - 5 + 2 = 18$ °C the heating valve is activated and starts modulating operation

At the temperature of $21 - 6 = 15$ °C the heater is activated (shutdown at 17 °C)

The activation of the devices according to the above-mentioned settings is represented in the following graph :

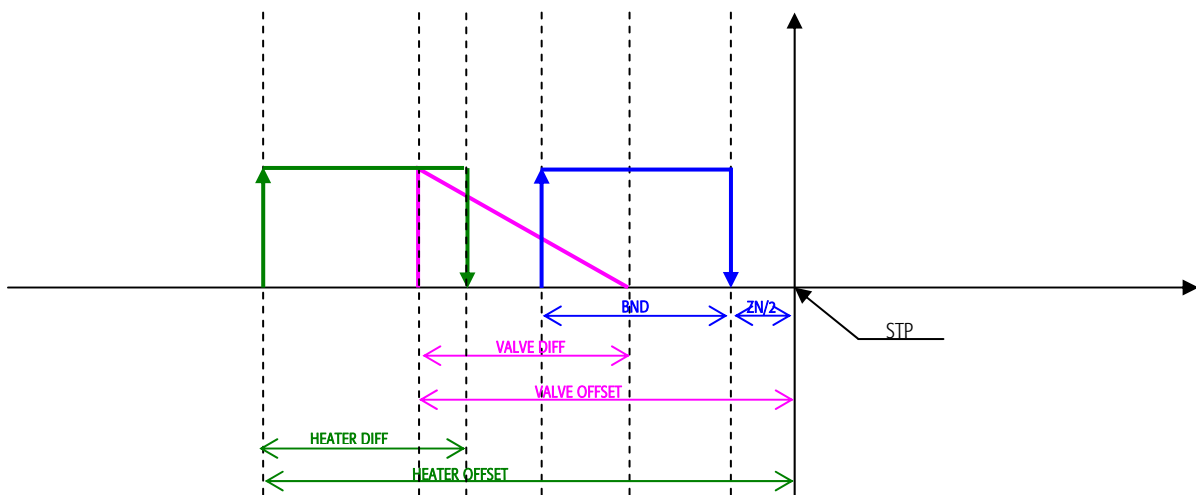

Example 2)

Configuration	1 Comp.	Heating valve	1 Aux. heater				
Parameters	STP = 21 °C	ZN/2 = 1 °C	BND = 3 °C	VALVE_OFFSET = 6	VALVE_DIFF = 2	HEAT_OFFSET = 11	HEAT_DIFF = 2

At the temperature of $21 - 1 - 3 = 17$ °C the compressor is started
 At the temperature of $21 - 7 + 2 = 15$ °C the heating valve is activated and starts modulating operation
 At the temperature of $21 - 11 = 10$ °C the heater is activated (shutdown at 12 °C)

The activation of the devices according to the above-mentioned settings is represented in the following graph:

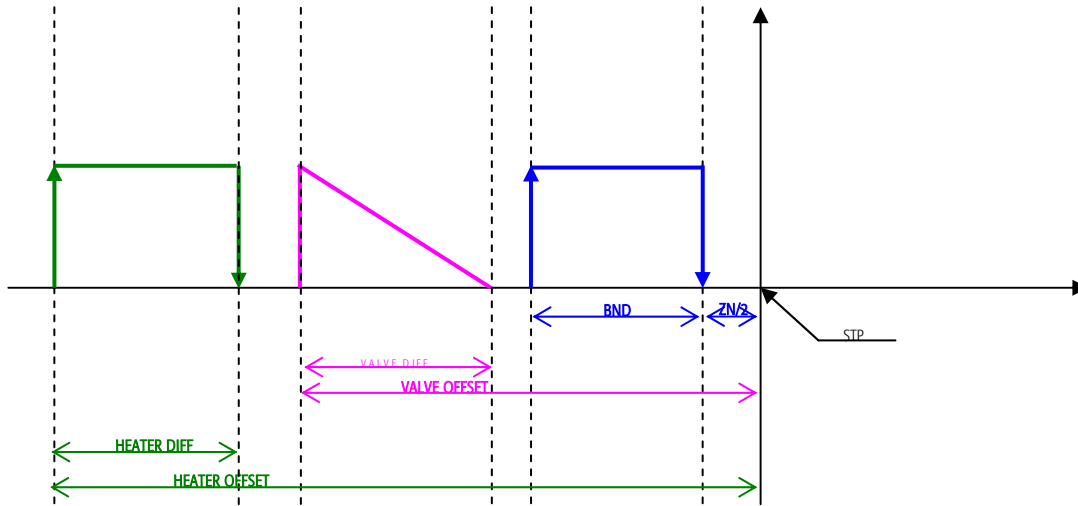

10.14 Set point compensation

Set point compensation allows energy saving when the outside temperature values are especially extreme compared to the needs of the controlled environment. The compensation function varies the control set point according to the outside temperature.

Inputs used:

Outside air temperature probe.

Devices used:

Compressor no. 1.
 Compressor no. 2.

Parameters used:

Enable compensation (G1).
 Compensation set point in heating on outside temperature (P6).
 Compensation band in heating on outside temperature (P6).
 Maximum compensation in heating (P6).
 Compensation set point in cooling on outside temperature (P5).
 Compensation band in cooling on outside temperature (P5).
 Maximum compensation in cooling (P5).

Description of operation

The set point compensation differs from heating operation to cooling operation in terms of the type of action and the parameters used.

Compensation in cooling

Set point compensation in cooling mode is active when the following conditions are true:

the unit is in cooling operation;

compensation is enabled on screen G1, manufacturer branch, password-protected.

Compensation in cooling mode sums a "delta" to the set point that depends on the outside temperature (as the outside temperature increases, the value of the delta increases).

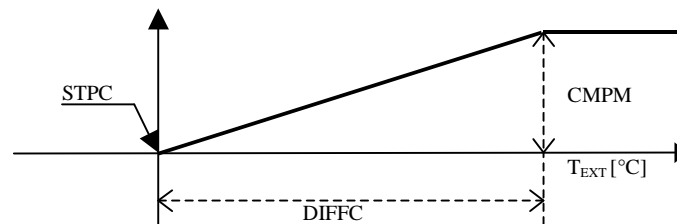

- STPC Compensation set point [°C]
- CMPM Maximum compensation [°C]
- DIFFC Compensation differential [°C]
- T_{EXT} Outside temperature [°C]

Compensation in heating

Set point compensation in heating mode is active when the following conditions are true:

the unit is in heating operation;

compensation is enabled on screen G1, manufacturer branch, password-protected:

Compensation in cooling mode subtracts a "delta" from the set point that depends on the outside temperature (as the outside temperature decreases, the value of the delta increases).

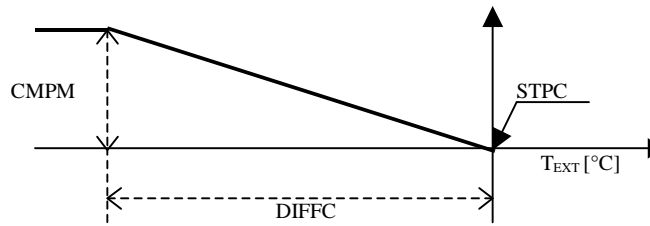

STPC	Compensation set point [°C]
CMPM	Maximum compensation [°C]
DIFFC	Compensation differential [°C]
T _{EXT}	Outside temperature [°C]

10.15 Heat recovery

This function is only supported on the pCO3 Large board.

Inputs used:

- Outside air temperature
- Discharge air temperature
- Ambient air temperature
- Ambient air relative humidity
- Outside air relative humidity

Parameters used:

- Enable heat recovery function (Ck)
- Select the type of heat recovery unit (Ck)
- Select the type of bypass damper (Cq)
- Position of the bypass damper (Cq)
- Select the type of rotor (Cn)
- Select the logic of the heat recovery unit digital output (Cn)
- Select minimum rotor speed (Co)
- Select minimum bypass damper opening (Co)
- Select control probe minimum (Cp)
- Recovery activation temperature delta (Pw)
- Recovery activation temperature differential (Pw)
- Recovery control temperature differential (Px)
- Recovery control temperature dead zone (Px)

Three types of heat recovery unit can be managed:

- Double coil heat recovery unit
- Rotary heat recovery unit
- Cross-flow heat recovery unit

All the types of heat recovery unit must respect the following conditions.

10.15.1 Recovery by temperature

Cooling mode

Recovery On → Outside temperature - return temperature > Recovery activation delta

Recovery Off → Outside temperature - return temperature < Recovery activation delta - Recovery activation differential

Heating mode

Recovery On → Return temperature - outside temperature > Recovery activation delta

Recovery Off → Return temperature - outside temperature < Recovery activation delta - Recovery activation differential

10.15.2 Recovery by enthalpy

The heat recovery based on enthalpy can only be performed using the rotary heat recovery unit.

The following diagram indicates the ideal conditions for heat recovery.

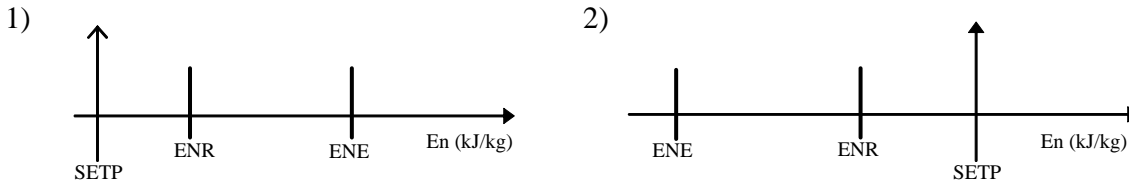

The conditions indicated in the following diagram show that heat recovery is possible, the conditions mean that the return enthalpy is near the enthalpy set point.

In these conditions, freecooling/freeheating are also possible, if enabled. (C4)

If freecooling/freeheating is enabled, the heat recovery function is disabled.

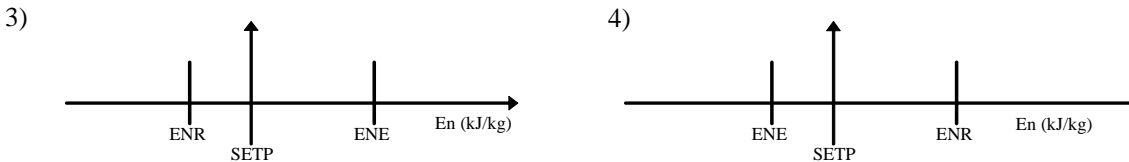

- SETP Enthalpy set point
- ENR Return enthalpy
- ENE Outside enthalpy

Outside of the above-mentioned conditions, heat recovery is not possible.

10.15.3 Dehumidification

When dehumidification is required, heat recovery is only possible in cooling mode.

10.15.4 Control probe

The heat recovery control probe may be:

- Return temperature
- Outlet temperature
- Return enthalpy
- Outlet enthalpy

If control is selected based on the outlet temperature or enthalpy, the control functions are based directly on these measurements.

If control is selected based on the return temperature or enthalpy, the control functions are based on the difference between the return and the outside conditions:

Temperature

Cooling mode (cooling):

Outside temperature – return temperature = control temperature

Heating mode (heating):

Return temperature – outside temperature = control temperature

Enthalpy

Outside enthalpy – return enthalpy = control enthalpy

10.15.5 Management of double coil heat recovery units

This type of heat recovery unit is used in separate flow systems, without mixing the return air and the outside air. The device controlled is the water circulating pump for the two coils. The pump is controlled via digital output 14. Control can only be performed based on the temperature, not on the enthalpy.

If the heat recovery conditions are available, the circulating pump is activated as shown in the following graphs, depending on the operating mode (cooling - heating):

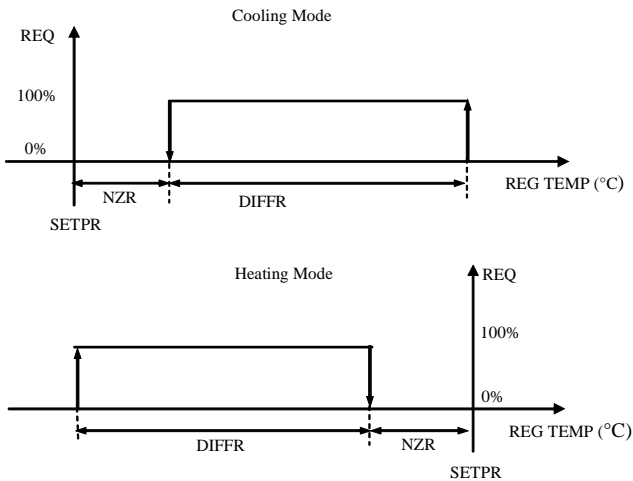

- REQ Pump request
- SETPR Recovery control set point
- DIFFR Temperature differential
- NZR Dead zone
- REG ENTH Control probe

Defrost

In the event of defrosts, the pump is forced on (DO14).

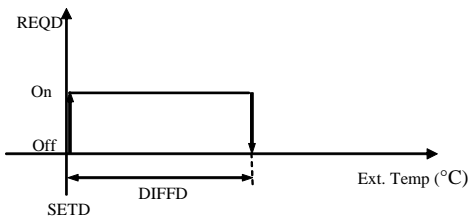

- REQD Defrost request
- SETD Defrost set point
- DIFFD Defrost differential
- Ext.Temp Outside temperature

The defrost is activated after the delay time set on screen Pn.

10.15.6 Management of rotary heat recovery units

The management of rotary heat recovery units involves the control of the following devices:

- Bypass damper
- Rotor on the rotary heat recovery unit

Management of the bypass damper

On screen Ck the user can enable and select the type of control of the bypass damper, choosing between the following options:

- No damper controlled
- Digital control (Digital output 14)
- Analogue control (Analogue output 5)

If the management of the bypass damper is enabled, the software closes the damper when the rotary heat recovery unit is not operating.

Management of the heat recovery unit rotor

The rotor on the heat recovery unit can be controlled as follows:

- Control via digital output (Digital output 14)
- Control via analogue output (Analogue output 5)

The conditions for the activation of the heat recovery function are described in the following paragraphs:

- 10.15.1 recovery by temperature
- 10.15.2 recovery by enthalpy

If the conditions are right for heat recovery, the software controls the heat recovery unit as shown in the following graphs:

Control via digital output

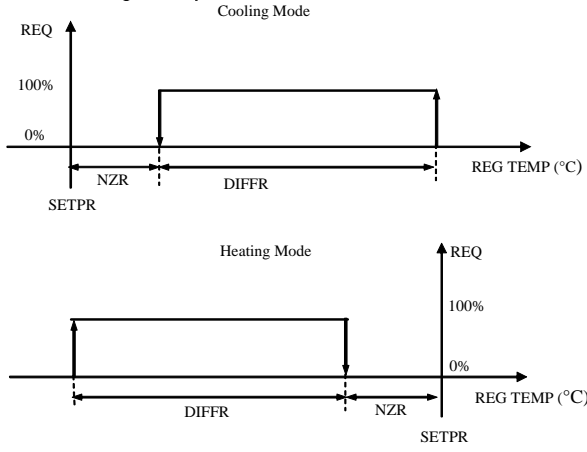

- REQ Pump request
- SETPR Recovery control set point
- DIFFR Temperature differential
- NZR Dead zone
- REG ENTH Control probe

Control via modulating output

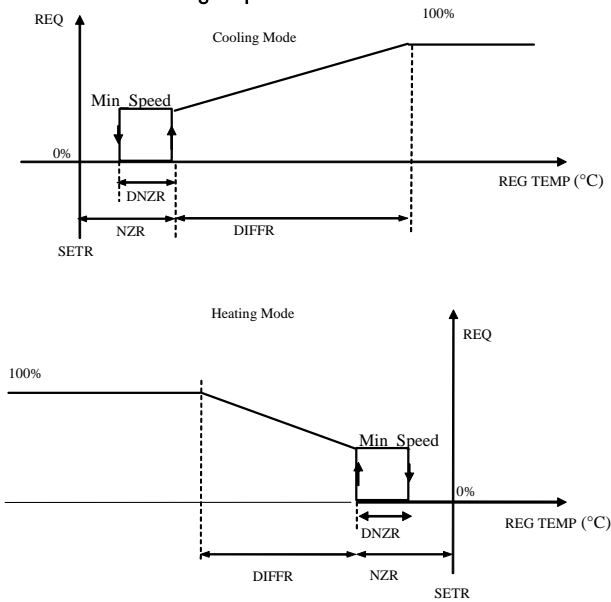

- REQ Rotor request
- SETR Temperature set point
- DIFFR Temperature differential
- NZR Dead zone
- DNZR Differential step for minimum speed
- Min Speed Minimum speed request
- REG TEMP Control probe

Enthalpy control

If the enthalpy conditions allow heat recovery, the speed of the rotor follows the trend described in the following graphs:

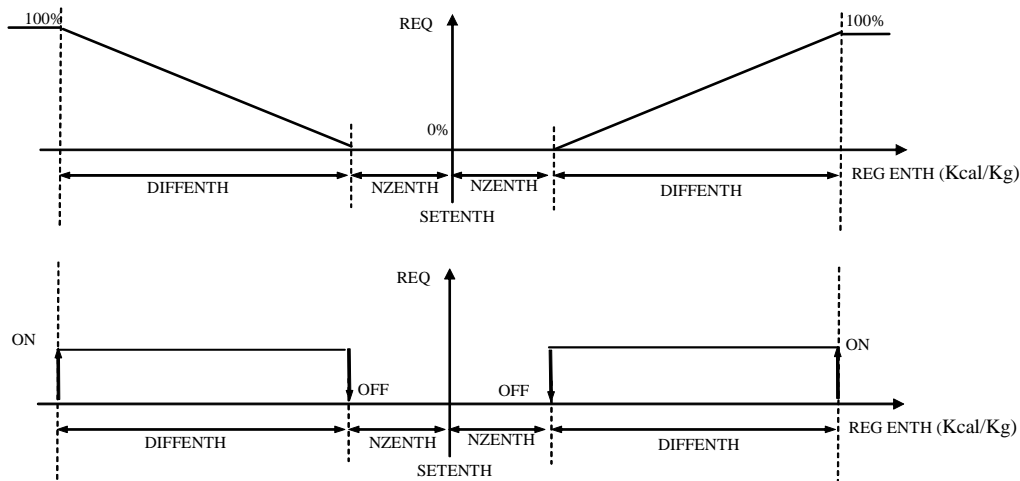

- REQ Rotor request
- SETENTH Enthalpy set point
- DIFFENTH Enthalpy differential
- NZENTH Enthalpy dead zone
- REG ENTH Control enthalpy

10.15.7 Management of cross-flow heat recovery units

Control is only based on the temperature, not on the enthalpy. The management of cross-flow heat recovery units involves the control of the bypass damper.

On screen Cq the user can select the type of bypass damper control, choosing between the following options:

- No damper controlled
- Digital control (Digital output 14)
- Analogue control (Analogue output 5)

Screen Cq is also used to select the position of the bypass damper:

- On the recovery device: the bypass damper is controlled as the rules described below. The external air damper is managed always according to the freecooling management.

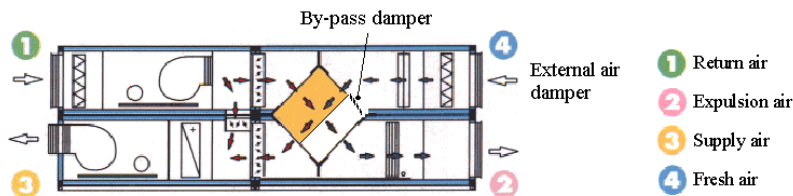

Modulating bypass damper:

If the conditions are right for heat recovery, the bypass damper follows the trend indicated in the following graphs:

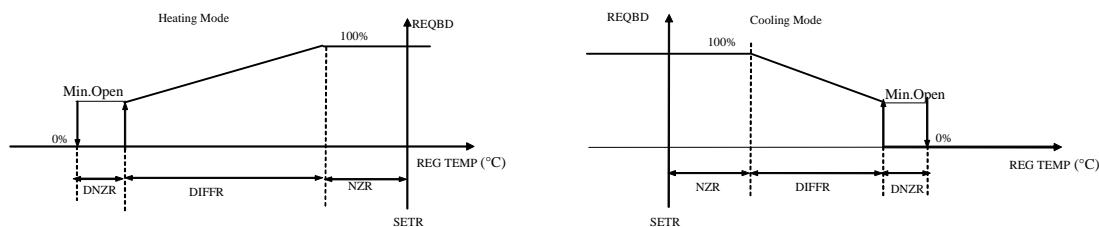

- REQBD Bypass damper request
- SETR Recovery temperature set point
- DIFFR Temperature differential
- NZR Dead zone
- DNZR Differential step for minimum opening
- Min.Open Minimum damper opening
- REG TEMP Control probe

Digital bypass damper:

If the conditions are right for heat recovery, the bypass damper must be closed (the air flows through the heat recovery device). If the conditions are not right for heat recovery, the bypass damper must be open (the air is not deviated through the heat recovery device).

- Additional damper:

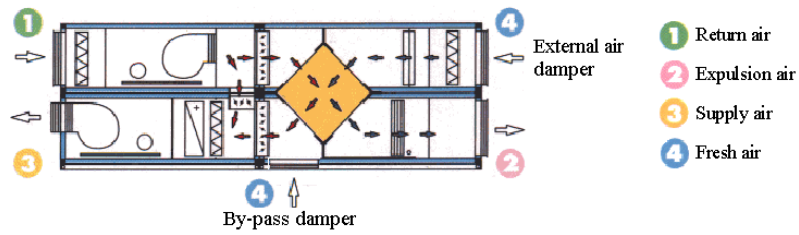

In this case, there is no a real heat recovery modulation in fact when the condition for heat recovery are right, then the recovery will be always 100%. So the dampers work as follows:

If the conditions are right for heat recovery, the bypass damper must be closed. The external air damper will be open 100% by heat recovery digital output.

If the conditions are not right for heat recovery, the bypass damper must be open, by modulation from minimum to 100% according to the freecooling management. The external air damper will be closed by heat recovery digital output.

So in this configuration the heat recovery digital output it is used to manage only the status (open or close) of the external air damper.

10.16 Dehumidification

This function is not available on the pCO[®] (humidity probe does not manage). The dehumidification action is performed by operating the compressors. The maximum number of compressor activated (1-4) in dehumidification mode can be set. The activation request for the compressors and any load steps depends on the dehumidification requirement.

Inputs used:

Ambient humidity.

Ambient temperature.

Devices used:

Compressor no. 1-4 (plus any load steps)

Parameters used:

Enable humidity control function (Ca).

Humidity set point in cooling (S2).

Humidity control band in cooling (Pc).

Humidity dead zone (Pc).

Number of compressors in dehumidification (G6).

Description of operation

Dehumidification is performed if the following conditions are true:

- the unit is in cooling operation;
- humidity control is enabled on screen Ca, manufacturer branch, password-protected;
- the number of compressors related to the dehumidification request is greater than or equal to 1 (screen G6, manufacturer branch, password-protected).



STPS	Humidity set point in cooling [RH%]
ZN	Dead zone [RH%]
BND	Humidity control band in cooling [RH%]
H _{AMB}	Ambient humidity [RH%]

For the compressors to be activated in response to a dehumidification request, the ambient temperature must have exceeded the control set point -15% of the band. The dehumidification function will continue until the temperature is lower than -85% of the band, as shown in the figure below:

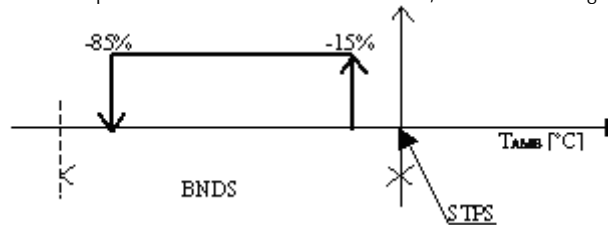

STPS	Cooling set point [°C]
BND	Control band humidity cooling [°C]
T _{AMB}	Ambient temperature [°C]

10.17 Post-heating during dehumidification

This function is not available on the pCO^{XS} (humidity probe does not manage). The post-heating action is performed by operating the heaters or heating valve. The activation request for the heaters or heating valve depends on the dehumidification and ambient temperature requirement. Post-heating is used only with dehumidification, and only in summer.

Inputs used:

Ambient humidity.

Ambient temperature.

Devices used:

Heater no. 1.

Heater no. 2.

Heating valve.

Parameters used:

Enable post-heating in dehumidification (Cr).

Enable humidity control function (C6).

Humidity set point in cooling (S2).

Humidity control band in cooling (Pc).

Humidity dead zone (Pc).

Number of compressors in dehumidification (G6).

Number of heaters set (C2).

Heater control offset (Pf).

Heater control differential (Pf).

Enable heating valve or heater number (C2).

Enable heater 1 (Pd).

Enable heater 2 (Pd).

Temperature control set point (S0/S1).

Description of operation

Post-heating is performed if the following conditions are true:

- the unit is in cooling operation;
- dehumidification is running;
- more than 1 heaters are set or heating valve is enabled on screen (C2), manufacturer branch, password-protected;
- heater 1 and 2 are enabled on screen (Pd) user branch, password-protected

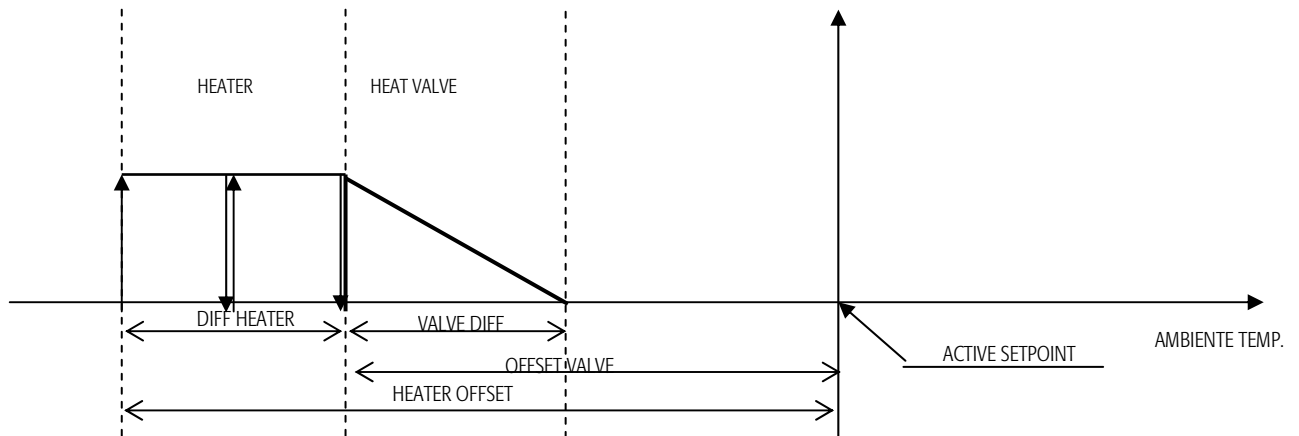

10.18 Humidification

This function is not available on the pCO². An external humidifier is controlled based on an on-off or modulating 0-10V signal (the latter on the pCO₂ large only). Two different humidity set points can be set, one for cooling operation and one for heating operation (S2,S3).

Inputs used:

Ambient humidity.

Devices used:

Enable humidifier digital output.

Modulating humidifier analogue output (pCO₂ large)

Parameters used:

Enable humidity management (C6).

Humidity set point in cooling (S2).

Humidity set point in heating (S3).

Humidity control band in cooling (Pc).

Humidity control band in heating (Pc).

Humidity dead zone (Pc).

Graph of the enable humidifier digital output

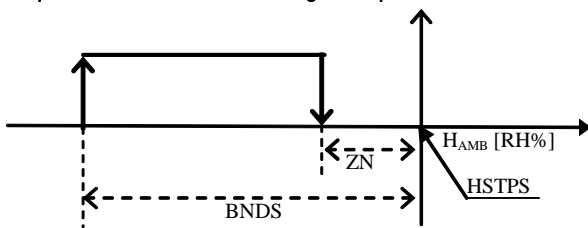

HSTPS Set point umidità [RH%]
 BNDS Banda di regolazione umidità [RH%]
 ZN Zona neutra umidità [RH%]
 H_{AMB} Umidità ambiente [RH%]

Graph of the modulating humidifier analogue output

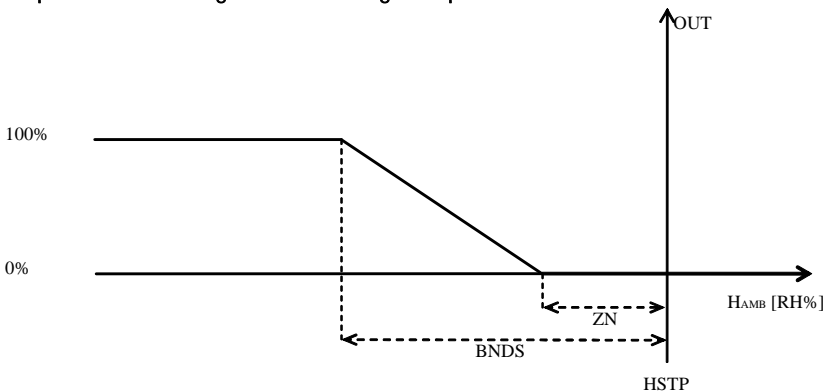

HSTPS Set point umidità cooling [RH%]
 BNDS Banda di regolazione umidità cooling [RH%]
 ZN Zona neutra umidità [RH%]
 H_{AMB} Umidità ambiente [RH%]

10.19 Freecooling and freeheating control by enthalpy

Freecooling and freeheating control by enthalpy means that the outside air damper is opened according to the inside and outside enthalpy conditions.

Inputs used:

Ambient temperature probe.

Outside temperature probe.

Ambient humidity probe.

Outside humidity probe.

Devices used:

Outside damper (analogue output no. 1).

Parameters used:

Enable freecooling in cooling (C4).

Enable freeheating in heating (C4).

Enable humidity control function (C6).

Enable freecooling and freeheating by enthalpy (C5).

Active temperature control set point (S0/S1).

Active humidity set point (S2/S3).

Enthalpy differential (Pi).

Description of operation:

The freecooling and freeheating control by enthalpy is enabled if the following conditions are always true:

the humidity management function is enabled on screen C6, manufacturer branch, password-protected;

the freecooling in cooling and freeheating in heating functions are enabled on screen C4, manufacturer branch, password-protected;

enthalpy control is enabled on screen C5, manufacturer branch, password-protected.

The ambient temperature and recirculation humidity are used by the controller to calculate the recirculation enthalpy (I6), while the outside temperature and humidity are used to calculate the outside enthalpy (I6), and the temperature and humidity set points are used to define the enthalpy set point. The purpose of the function is to maintain the recirculation enthalpy as near as possible to the enthalpy set point.

The following conditions are possible:

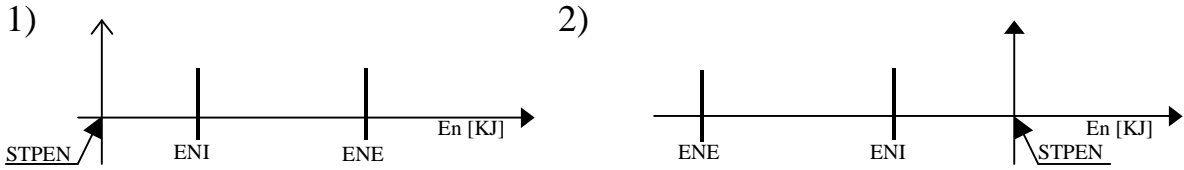

In both the conditions described above in the graphs (1, 2), it is not useful to open the outside damper, as the inside enthalpy is closer to the enthalpy set point than the outside enthalpy.

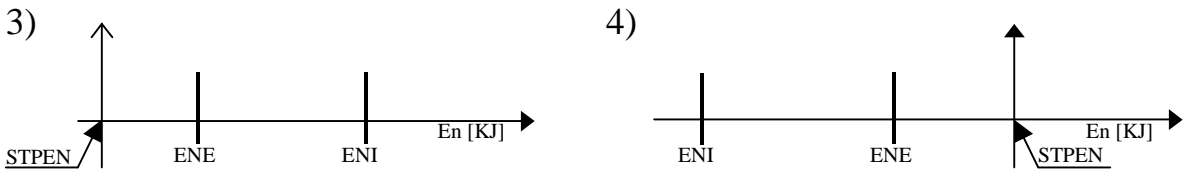

In both the conditions described above in the graphs (3, 4) it will be useful to open the outside damper, as the outside enthalpy is closer to the enthalpy set point than the inside enthalpy.

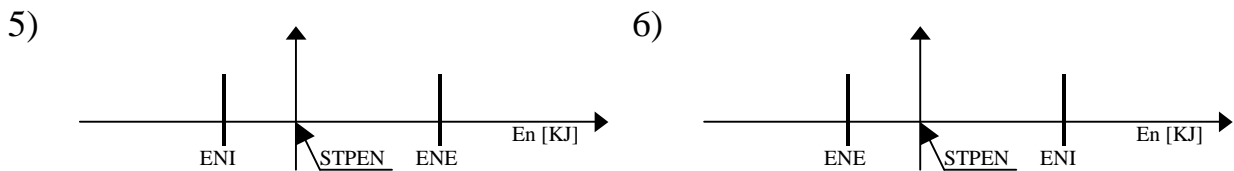

STPENS Enthalpy set point [KJ]
 ENI Inside enthalpy [KJ]
 ENE Outside enthalpy [KJ]

In case number 5 shown above in the graph, the inside enthalpy is closer to the enthalpy set point than the outside enthalpy, however in this case it is useful to open the damper as mixing the two enthalpies (inside and outside) will bring the inside enthalpy closer to the enthalpy set point.

In case number 6 shown above in the graph, the outside enthalpy is closer to the enthalpy set point than the inside enthalpy, consequently it is useful to open the damper as mixing the inside and outside air will bring the inside enthalpy closer to the enthalpy set point.

If the conditions are the same as shown above in the graphics (3, 4, 5, 6), the damper will be opened according to the inside enthalpy, as shown in the figure below:

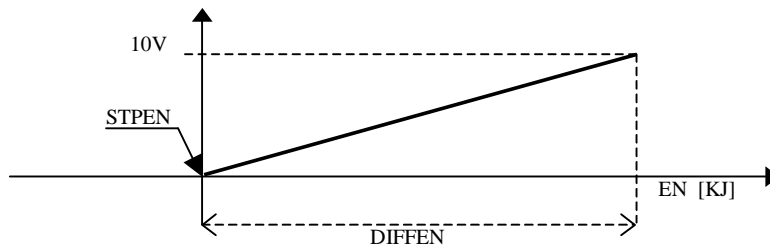

STPEN Enthalpy set point [KJ]
 DIFFEN Enthalpy differential [KJ]
 EN Ambient enthalpy [KJ]

11. Alarm management

When an alarm is activated, actions are performed on the devices, where configured, the buzzer, LED and remote relay are activated, and the corresponding screen is displayed.

To monitor the active alarm simply press the Alarm button, and use the UP/DOWN buttons to scroll any other active alarms. To reset the alarms, first display the alarm and then press the ALARM button again. If the alarm condition is no longer active, the alarm will be reset. For the "Automatic" reset alarm, when it changes from active to inactive, the corresponding logic will start working as normal. But the LED still keeps active, until press the ALARM button.

Code	Alarm description	Action	Reset	Delay	Notes
AL01	Compressor 1 thermal overload	Comp. 1 off/Circuit 1 off	Manual	No	Circuit/compressor configuration
AL02	Compressor 2 thermal overload	Comp. 2 off/Circuit 2 off	Manual	No	
AL03	Compressor 1 HP (pressure switch)	Circuit 1 off	Manual	No	
AL04	Compressor 2 HP (pressure switch)	Circuit 2 off	Manual	No	
AL05	Antifreeze alarm	Circuits off (cooling only)	Automatic	No	
AL06	High ambient temperature	/	Manual	Settable	
AL07	Low ambient temperature	/	Manual	Settable	
AL08	Compressor 1 LP in cooling (pressure switch)	/	Manual	Settable*	
AL09	Compressor 2 LP in cooling (pressure switch)	/	Manual	Settable*	
AL10	Compressor 1 LP in heating (pressure switch)	/	Automatic	Settable*	
AL11	Compressor 2 LP in heating (pressure switch)	/	Automatic	Settable*	
AL12	Compressor 1 maintenance	/	Manual	No	Display only
AL13	Compressor 2 maintenance	/	Manual	No	Display only
AL14	Unit maintenance	/	Manual	No	Display only
AL15	Main fan thermal overload	Unit off	Manual	No	
AL16	Dirty filter	/	Manual	Settable	Display only
AL17	Heater 1 and 2 overload	Heaters off	Manual	No	Display only
AL18	Flow switch alarm	Unit off	Manual	Settable	
AL19	Clock board fault or absent	/	Manual	No	
AL20	Cool set point less than Heat set point	/	Manual	No	
AL21	Probe B1 fault	Completely off (if ambient temp. probe)	Manual	60 s	**
AL22	Probe B2 fault	/	Manual	60 s	
AL23	Probe B6 fault	/	Manual	60 s	
AL24	Probe B7 fault	/	Manual	60 s	
AL25	Probe B4 fault	/	Manual	60 s	
AL26	Probe B3 fault	/	Manual	60 s	
AL27	Probe B8 fault	/	Manual	60 s	
AL28	Probe B5 fault	Completely off (if ambient temp. probe)	Manual	60 s	**
AL29	Heater 1 thermal overload	Heater 1 off	Manual	No	
AL30	Heater 2 thermal overload	Heater 2 off	Manual	No	
AL31	Serious alarm from digital input	Unit off	Manual	No	
AL32	Minor alarm from digital input	/	Manual	No	Display only
AL33	Compressor 3 thermal overload		Manual	No	
AL34	Compressor 4 thermal overload		Manual	No	
AL35	Compressor 3 maintenance	/	Manual	No	
AL36	Compressor 4 maintenance	/	Manual	No	
AL40	Driver 1 EEPROM error	Circuit 1 off	Manual	No	
AL41	Driver 2 EEPROM error	Circuit 2 off	Manual	No	
AL42	Driver 1 EEV motor error	Circuit 1 off	Manual	10 s	
AL43	Driver 2 EEV motor error	Circuit 2 off	Manual	10 s	
AL44	Driver 1 MOP timeout	Circuit 1 off	Manual	No	
AL45	Driver 2 MOP timeout	Circuit 2 off	Manual	No	
AL46	Driver 1 LOP timeout	Circuit 1 off	Manual	No	
AL47	Driver 2 LOP timeout	Circuit 2 off	Manual	No	
AL48	Driver 1 low superheat	Circuit 1 off	Manual	No	
AL49	Driver 2 low superheat	Circuit 2 off	Manual	No	
AL50	Driver 1 valve not closed during power OFF	Circuit 1 off	Manual	No	
AL51	Driver 2 valve not closed during power OFF	Circuit 2 off	Manual	No	
AL52	Driver 1 high superheat	Circuit 1 off	Manual	No	
AL53	Driver 2 high superheat	Circuit 2 off	Manual	No	
AL54	Driver 1 probe S1 error	Circuit 1 off	Manual	No	
AL55	Driver 2 probe S1 error	Circuit 2 off	Manual	No	
AL56	Driver 1 probe S2 error	Circuit 1 off	Manual	No	
AL57	Driver 2 probe S2 error	Circuit 2 off	Manual	No	

AL58	Driver 1 probe S3 error	Circuit 1 off	Manual	No	
AL59	Driver 2 probe S3 error	Circuit 2 off	Manual	No	
AL60	Driver 1 go-ahead request	Circuit 1 off	Manual	No	
AL61	Driver 2 go-ahead request	Circuit 2 off	Manual	No	
AL62	Driver 1 LAN disconnected	Circuit 1 off	Manual	30 s	
AL63	Driver 2 LAN disconnected	Circuit 2 off	Manual	30 s	
AL64	Driver 1 autoseup not complete	Circuit 1 off	Manual	No	
AL65	Driver 2 autoseup not complete	Circuit 2 off	Manual	No	
AL66	Circuit 1 in Prevent mode	Compressors off in circuit 1	Automatic	10 s	
AL67	Circuit 2 in Prevent mode	Compressors off in circuit 2	Automatic	10 s	

* with delay from activation of the compressor

** if the probe is the ambient temperature probe the unit is stopped

11.1 Low pressure alarm circuit 1/2 in cooling/heating

The low pressure alarm is managed separately in each circuit and operating mode (cooling or heating).

In cooling mode, the alarm is ignored for a set time (T2) from when the compressor starts, while in heating mode operation is similar to cooling except for defrost phase, during which the alarm is disabled.

11.2 Cooling set point less than heating set point alarm

This alarm is active only when the automatic cooling/heating changeover function is enabled (C6).

The software checks that the cooling set point is always higher than the heating set point, and where necessary generates a display-only alarm.

11.3 Alarm log

The log is only available if the board is fitted with the clock.

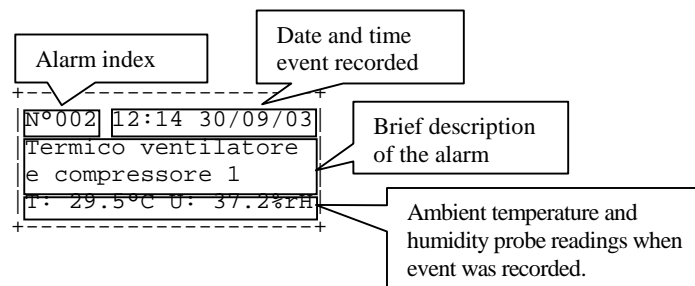

All alarms are saved in the log, pressing the PRINTER button displays the last event, and then the UP/DOWN buttons can be used to scroll the various alarms saved; the number of events shown at the top left increases with each new alarm, a maximum of 150 events can be saved. Once having reached the maximum number of events, the new events overwrite the oldest ones. The alarm log can be reset on screen "Am", in the password-protected section of the service branch.

The alarm log can be deleted as follows:

- installing the default values;
- by parameter on the delete log screen (Am).

11.4 SMS on alarm

If a GSM modem is connected to the board, the unit can send SMS messages when an alarm is activated.

The SMS is sent at the moment the alarm is activated.

12. Service

12.1 Compressor and unit hour counter settings

These settings manage the compressor and unit maintenance alarms.

Parameters used:

Unit maintenance alarm operating hour threshold (A7)

Reset unit hour counter (Ac)

Compressor maintenance alarm operating hour threshold (A8 to Ab)

Reset compressor hour counter (Ad, Ae)

Description of operation

The controller counts the operating hours of the devices: compressors and unit.

When the hour counter for the individual device reaches the alarm threshold, the maintenance alarm for the corresponding device is activated. The maintenance alarm is signal only.

12.2 Probe calibration

These settings manage the calibration and the type of probes connected.

Inputs used:

Ambient air temperature.

Outside air temperature.

Defrost/condenser temperature no. 1.

Defrost/condenser temperature no. 2.

Ambient air relative humidity.

Outside air relative humidity.

Supply air temperature.

Parameters used:

Ambient air temp. probe calibration (Af).

Outlet air temp. probe calibration (Af).

Outside air temp. probe calibration (Ag).

Recirculation humidity probe calibration (Ah).

Outside humidity probe calibration (Ah).

Defrost/cond. temp. probe 1 calibration (Ai).

Defrost/cond. temp. probe 2 calibration (Ai).

Air quality probe calibration (CO₂) (Aj)

EVD Driver 1 probe offset (Ak)

EVD Driver 2 probe offset (Al)

Description of operation

The probes are calibrated by setting an offset for each probe.

The parameter setting is summed to the value read by the corresponding probe.

12.3 Test Inputs/Outputs

The test Inputs/Outputs function is used to quickly check the analogue inputs and digital outputs.

Inputs used:

- All analogue inputs

Devices used:

- All digital outputs

Parameters used:

- Close/open all the relay outputs (An to Ar).

Description of operation

To be able to test the digital outputs, the unit must be off. Screens An to Ar can be used to manually activate and deactivate the relay outputs.

13. Time bands

This function is available only if the pCO* board is fitted with the clock board.

Two types of time bands can be configured:

Weekly time bands

Daily time bands

13.1 Weekly time bands

The weekly time bands manage the activation and deactivation of the unit during the week, separately from the daily ON/OFF times.

Parameters used:

Enable weekly time bands (K6).

Unit activation Monday to Sunday (K7).

Description of operation:

The weekly time bands are active if the function has been enabled on screen (K6), in the clock branch.

For each day of the week, a parameter is set that manages the activation and deactivation of the unit.

At midnight each day, the pCO checks the status of the variable and, as a consequence, switches the unit on or off.

Example:

Weekly time band function enabled

Unit activation Monday = ON

Unit activation Tuesday = ON

Unit activation Wednesday = ON

Unit activation Thursday = ON

Unit activation Friday = OFF

Unit activation Saturday = OFF

Unit activation Sunday = OFF

In this configuration, the unit will be On from Monday at 00:00 to Thursday night at 23:59, and then will be Off from Friday at 00:00 until Sunday night at 23:59.

13.2 Daily time bands

The daily time bands manage the control set point and the activation of the main fan, as a consequence switching off all the devices on the unit.

Parameters used:

Enable daily time band (K2)

Shutdown main fan outside of the band (K2)

Daily time band start time (K3)

Daily time band end time (K3)

Set point inside the band in cooling (K4)

Set point outside the band in cooling (K4)

Set point inside the band in heating (K5)

Set point outside the band in heating (K5)

Description of operation:

The daily time bands can be enabled on screen K2, in the clock branch.

Setting the start band hours and minutes and the end band hours and minutes on screen K3 automatically identifies 2 zones: one "inside the band" and one "outside the band". For each of these two zones, two set points can be defined, one for cooling operation and one for heating operation.

The shutdown of the main fan can be selected "outside of the band".

14. Supervisor variables

The pCO* can be connected to a local or remote supervisor/telemaintenance system used to control the unit.

The accessories available for the pCO* boards include an optional RS485 serial communication board.

In this software version, the baud rate can be set to the following values: 1200, 2400, 4800, 9600 or 19200 bps.

The variables sent to and received from the supervisor are shown in the tables below, with reference to the following key:

R Read sent from the pCO* to the supervisor
R/W Read/writer received from and sent by the pCO* to the supervisor

14.1 Digital variables

DESCRIPTION	ADD.	TYPE
Digital input 1	1	R
Digital input 2	2	R
Digital input 3	3	R
Digital input 4	4	R
Digital input 5	5	R
Digital input 6	6	R
Digital input 7	7	R
Digital input 8	8	R
Digital input 9	9	R
Digital input 10	10	R
Digital input 11	11	R
Digital input 12	12	R
Digital input 13	13	R
Digital input 14	14	R
Digital input 15	15	R
Digital input 16	16	R
Digital input 17	17	R
Digital input 18	18	R
Digital output 1	19	R
Digital output 2	20	R
Digital output 3	21	R
Digital output 4	22	R
Digital output 5	23	R
Digital output 6	24	R
Digital output 7	25	R
Digital output 8	26	R
Digital output 9	27	R
Digital output 10	28	R
Digital output 11	29	R
Digital output 12	30	R
Digital output 13	31	R
Digital output 14	32	R
Digital output 15	33	R
Digital output 16	34	R
Digital output 17	35	R
Cooling/Heating changeover. The flow depends on the value of parameter I-87 as follows : 0 : Read / Write 1 : Read 2 : Read	43	R/W
Type of defrost (temperature/pressure)	44	R
Unit State 0: Off 1: On	45	R
Reset alarms from the supervisor	46	R/W
New hours and date confirm: 0: not confirm 1: confirm The variable will be toun 0 automaticaly	47	R/W
Unit ON/OFF from the supervisor 0: Off 1: On	48	R/W
Compressor 1 thermal overload alarm	49	R
Compressor 2 thermal overload alarm	50	R
Compressor 3 thermal overload alarm	51	R

Compressor 4 thermal overload alarm	52	R
High pressure alarm, circuit 1	53	R
High pressure alarm, circuit 2	54	R
Antifreeze alarm	55	R
Inside temperature above the threshold alarm	56	R
Inside temperature below the threshold alarm	57	R
Compressor 1 maintenance alarm	58	R
Compressor 2 maintenance alarm	59	R
Compressor 3 maintenance alarm	60	R
Compressor 4 maintenance alarm	61	R
Unit maintenance alarm	62	R
Main fan overload alarm	63	R
Dirty filter alarm	64	R
Heater 1 and 2 thermal overload alarm	65	R
Heater 1 thermal overload alarm	66	R
Heater 2 thermal overload alarm	67	R
Low pressure circuit 1 in cooling	68	R
Low pressure circuit 2 in cooling	69	R
Low pressure circuit 1 in heating	70	R
Low pressure circuit 2 in heating	71	R
Flow switch alarm	72	R
Clock board absent or faulty alarm	73	R
Cooling set point < Heating set point alarm	74	R
Probe B1 faulty or disconnected alarm	75	R
Probe B2 faulty or disconnected alarm	76	R
Probe B6 faulty or disconnected alarm	77	R
Probe B7 faulty or disconnected alarm	78	R
Probe B4 faulty or disconnected alarm	79	R
Probe B3 faulty or disconnected alarm	80	R
Probe B8 faulty or disconnected alarm	81	R
Probe B5 faulty or disconnected alarm	82	R
Enable heat pump operation	83	R/W
Enable humidity management	84	R/W
Enable outlet temperature probe	85	R/W
Enable freecooling control by enthalpy	86	R/W
Enable freecooling in cooling	87	R/W
Enable freeheating in heating	88	R/W
Enable damper opening when starting in heating	89	R/W
Enable set point compensation	90	R/W
Enable shutdown main fan during defrost	91	R/W
Enable simultaneous circuit defrost	92	R/W
Enable automatic restart after black out	93	R/W
Enable remote ON/OFF	94	R/W
Enable time bands	95	R/W
Enable freecooling in heating	96	R/W
Type of control 0: Proportional 1: Proportional + Integral	97	R/W
Enable compressor rotation	98	R/W
Weekly time bands: Sunday on/off	99	R/W
Weekly time bands: Monday on/off	100	R/W
Weekly time bands: Tuesday on/off	101	R/W
Weekly time bands: Wednesday on/off	102	R/W
Weekly time bands: Thursday on/off	103	R/W
Weekly time bands: Friday on/off	104	R/W

Weekly time bands: Saturday on/off	105	R/W
Enable fans in coupled mode	106	R/W
Enable outside temperature probe	107	R/W
Enable outside humidity probe	108	R/W
Enable condenser/defrost probe 1	109	R/W
Enable condenser/defrost probe 2	110	R/W
Enable CO2 probe for air quality	111	R/W
Enable flow switch	112	R/W
Defrost probe 1 type 0: 4-20mA 1: 0-5V	113	R/W
Defrost probe 2 type 0: 4-20mA 1: 0-5V	114	R/W
Enable unit OFF from weekly time bands	115	R/W
Enable prevent function	116	R/W
Enable inside humidity probe	117	R/W
Enable EVD400 drivers	118	R/W
Load step logic 0: N.O. 1: N.C.	119	R/W
Reversing valve logic 0: N.C. 1: N.O.	120	R/W
Enable heating valve	121	R/W
Enable simultaneous end for simultaneous defrosts 0: simultaneous 1: not simultaneous	122	R/W
Enable main fan OFF from daily time bands	123	R/W
EEPROM error alarm, Driver 1	124	R
EEPROM error alarm, Driver 2	125	R
EEV motor error alarm, Driver 1	126	R
EEV motor error alarm, Driver 2	127	R
MOP timeout alarm, Driver 1	128	R
MOP timeout alarm, Driver 2	129	R
LOP timeout alarm, Driver 1	130	R
LOP timeout alarm, Driver 2	131	R
Low superheat alarm, Driver 1	132	R
Low superheat alarm, Driver 2	133	R
Valve error alarm, Driver 1	134	R

Valve error alarm, Driver 2	135	R
High superheat alarm, Driver 1	136	R
High superheat alarm, Driver 2	137	R
Probe S1 error alarm, Driver 1	138	R
Probe S1 error alarm, Driver 2	139	R
Probe S2 error alarm, Driver 1	140	R
Probe S2 error alarm, Driver 2	141	R
Probe S3 error alarm, Driver 1	142	R
Probe S3 error alarm, Driver 2	143	R
Go-ahead alarm, Driver 1	144	R
Go-ahead alarm, Driver 2	145	R
LAN disconnected alarm, Driver 1	146	R
LAN disconnected alarm, Driver 2	147	R
Autosetup not complete alarm, Driver 1	148	R
Autosetup not complete alarm, Driver 2	149	R
Wait battery alarm, Driver 1	150	R
Wait battery alarm, Driver 2	151	R
Reset go-ahead, Driver 1	152	R/W
Reset go-ahead, Driver 2	153	R/W
Driver 1 in manual mode	154	R
Driver 2 in manual mode	155	R
Double coil heat recovery - pump status	156	R
Cross-flow heat recovery - bypass damper status	157	R
Rotary heat recovery - rotor status	158	R
Heat recovery digital output logic 0: N.O. 1: N.C.	159	R
Defrost status in heat recovery 0: condition not OK 1: condition OK	160	R
Status of the conditions for the activation of heat recovery	161	R
Type of rotor for rotary heat recovery 0: DIGITAL 1: MODULATING	162	R
Status of heat recovery digital output	163	R
Enable post heating during dehumidification	164	R/W

14.2 Analogue variables

DESCRIPTION	ADD.	TYPE
Analogue input 1	1	R
Analogue input 2	2	R
Analogue input 3	3	R
Analogue input 4	4	R
Analogue input 5	5	R
Analogue input 6	6	R
Analogue input 7	7	R
Analogue input 8	8	R
Temperature set point in cooling	9	R/W
Temperature set point in heating	10	R/W
Humidity set point in cooling	11	R/W
Humidity set point in heating	12	R/W
Temperature set point upper limit	13	R/W
Temperature set point lower limit	14	R/W
Temperature control band in cooling	15	R/W
Temperature control band in heating	16	R/W
Humidity set point upper limit	17	R/W
Humidity set point lower limit	18	R/W
Humidity control band in cooling	19	R/W
Humidity control band in heating	20	R/W
Condenser fan set point	21	R/W
Condenser fan differential	22	R/W
Freecooling/freeheating activation differential	23	R/W

Freecooling offset (cooling set point)	24	R/W
Freecooling differential	25	R/W
Freeheating offset (heating set point)	26	R/W
Freeheating differential	27	R/W
Minimum outlet temperature limit - set point	28	R/W
Minimum outlet temperature limit - differential	29	R/W
Compensation set point in cooling	30	R/W
Compensation differential in cooling	31	R/W
Maximum compensation in cooling	32	R/W
Compensation set point heating	33	R/W
Compensation differential heating	34	R/W
Maximum compensation heating	35	R/W
Start defrost set point	36	R/W
End defrost set point	37	R/W
Maximum fan speed	38	R/W
Minimum fan speed	39	R/W
Prevent set point	40	R/W
Prevent differential	41	R/W
Heat recovery activation temperature delta	42	R/W
Heat recovery activation differential	43	R/W
Heat recovery control by temperature - differential	44	R/W
Heat recovery control by temperature - dead zone	45	R/W
Temperature control dead zone	46	R/W
Humidity control dead zone	47	R/W

Maximum temperature limit in cooling	48	R/W
Minimum temperature limit in cooling	49	R/W
Maximum temperature limit in heating	50	R/W
Minimum temperature limit in heating	51	R/W
Inside temperature probe calibration	52	R/W
Outside temperature probe calibration	53	R/W
Outlet temperature probe calibration	54	R/W
Defrost probe 1 calibration	55	R/W
Defrost probe 2 calibration	56	R/W
Heater offset	57	R/W
Heater differential	58	R/W
Inside humidity probe calibration	59	R/W
Outside humidity probe calibration	60	R/W
Temperature set point outside the time bands in heating	61	R/W
Temperature set point outside the time bands in cooling	62	R/W
Temperature set point inside the time bands in heating	63	R/W
Temperature set point inside the time bands in cooling	64	R/W
Heating valve offset	65	R/W
Heating valve differential	66	R/W
Outside enthalpy	67	R
Inside enthalpy	68	R
Enthalpy set point	69	R
Superheat set point, Driver 1	70	R/W
Superheat set point, Driver 2	71	R/W

LOP threshold, Driver 1	72	R
LOP threshold, Driver 2	73	R
MOP threshold, Driver 1	74	R
MOP threshold, Driver 2	75	R
Maximum superheat, Driver 1	76	R
Maximum superheat, Driver 2	77	R
Current superheat, Driver 1	78	R
Current superheat, Driver 2	79	R
Saturation temperature, Driver 1	80	R
Saturation temperature, Driver 2	81	R
Suction temperature, Driver 1	82	R
Suction temperature, Driver 2	83	R
Suction pressure, Driver 1	84	R
Suction pressure, Driver 2	85	R
Heat recovery control by temperature - dead zone diff.	86	R/W
Heat recovery control by enthalpy - differential	87	R/W
Heat recovery control by enthalpy - dead zone	88	R/W
Defrost set point (Heat recovery)	89	R/W
Defrost differential (Heat recovery)	90	R/W
Heat recovery output (0-100%) with modulating bypass damper	91	R
Heat recovery output (0-100%) with modulating rotor	92	R
Actual setpoint	93	R

14.3 Integer variables

DESCRIPTION	ADD.	TYPE
Analogue output 1 (%) - Outside air damper	1	R
Analogue output 2 (%) - Heating valve	2	R
Analogue output 3 (%) - Fan 1	3	R
Analogue output 4 (%) - Fan 2	4	R
Analogue output 5 (%) - Bypass damper/rotor	5	R
Analogue output 6 (%) - Modulating humidifier	6	R
Unit status 0: UNIT ON 1: OFF FROM ALARM 2: OFF FROM SUPERV. 3: OFF FROM BANDS 4: OFF FROM DIN 5: OFF FROM KEY. 6: MANUAL PROC.	7	R
Inside temperature probe type 0: NTC 1: PT1000 2: 0-1V 3: 0-10V 4: 4-20mA 5: 0-20mA 6: 0-5V	8	R
Outside temperature probe type 0: NTC 1: PT1000 2: 0-1V 3: 0-10V 4: 4-20mA 5: 0-20mA 6: 0-5V	9	R
Outlet temperature probe type 0: NTC 1: PT1000 2: 0-1V 3: 0-10V 4: 4-20mA 5: 0-20mA 6: 0-5V	10	R
CO2 probe type 0: --- 1: --- 2: 0-1V 3: 0-10V 4: 4-20mA 5: 0-20mA	11	R

Inside relative humidity probe type 0: --- 1: --- 2: 0-1V 3: 0-10V 4: 4-20mA 5: 0-20mA	12	R
Outside relative humidity probe type 0: --- 1: --- 2: 0-1V 3: 0-10V 4: 4-20mA 5: 0-20mA	13	R
High and low temperature alarm delay (minutes)	14	R/W
Low pressure alarm delay	15	R/W
Number of compressors in dehumidification	16	R/W
Main fan off delay	17	R/W
Compressor start delay	18	R/W
Compressor OFF time during start/end defrost	19	R/W
Minimum compressor OFF time	20	R/W
Minimum time between starts of same compressor	21	R/W
Time between starts of different compressors	22	R/W
Minimum compressor ON time	23	R/W
Delay between compressor start and capacity-control	24	R
Type of fan control 0: Compressor 1: Pressure 2: Temperature	25	R/W
Number of circuits	26	R
Compressor configuration 0: --- 1: 1 COMPRESSOR 2: 1 COMPRESSOR+1 STEP 3: 2 COMPRESSORS 4: 2 COMPRESSORS+2 STEPS 5: 4 COMPRESSORS	27	R
Type of heat recovery 1: CROSS-FLOW 2: ROTARY 3: DOUBLE COIL	28	R
Type of bypass damper (No/Digital/Analogue) 1: NO 2: DIGITAL 3: ANALOGUE	29	R
Flow switch alarm delay at start-up	30	R/W

Flow switch alarm delay in normal operation	31	R/W
Defrost start delay (minutes)	32	R/W
Maximum defrost time (minutes)	33	R/W
Minimum outside damper opening	34	R/W
Unit operating hour threshold (x1000)	35	R/W
Compressor 1 operating hour threshold (x1000)	36	R/W
Compressor 2 operating hour threshold (x1000)	37	R/W
Number of heaters	38	R
Type of heating 0: HEATERS ONLY 1: HEATING VALVE ONLY 2: HEATERS+HEATING VALVE	39	R
Start daily time band (hour)	40	R/W
End daily time band (hour)	41	R/W
Start daily time band (minutes)	42	R/W
End daily time band (minutes)	43	R/W
Date/time setting: minutes	44	R/W
Date/time setting: hours	45	R/W
Date/time setting: day	46	R/W
Date/time setting: month	47	R/W
Date/time setting: year	48	R/W
Compressor 1 operating hours (high part)	49	R
Compressor 1 operating hours (low part)	50	R
Compressor 2 operating hours (high part)	51	R
Compressor 2 operating hours (low part)	52	R
Unit operating hours (high part)	53	R
Unit operating hours (low part)	54	R
Clock (minutes)	55	R
Clock (hours)	56	R
Clock (day)	57	R
Clock (month)	58	R
Clock (year)	59	R
Filter alarm delay	60	R
Minimum condenser ON time	61	R/W
Integral time for the Prop.+ Integral control	62	R/W
Compressor operating hours 3 (high part)	63	R
Compressor operating hours 3 (low part)	64	R
Compressor operating hours 4 (high part)	65	R
Compressor operating hours 4 (low part)	66	R
Compressor 3 operating hour threshold (x1000)	67	R/W
Compressor 4 operating hour threshold (x1000)	68	R/W
Driver 1 firmware (low part)	69	R
Driver 2 firmware (low part)	70	R
Driver 1 firmware (high part)	71	R
Driver 2 firmware (high part)	72	R
Type of EVD 0: --- 1: EVD400 pLAN 2: EVD400 tLAN	73	R
Type of EVD probes 0: Non selez. 1: SHeat NTC-P(4-20)mA 2: SHeat NTC-P(raz) 3: SHeat NTC-NTC 4: SHeat Pt1000-P 5: SHeat NTChT-P(raz)	74	R
Type of electronic valve 0: Not used 1: Alco EX5 2: Alco EX6 3: Alco EX7 4: ALCO EX8 330 step/s 5: SPORLAND 0.5-20tons 6: SPORLAND 25-30tons 7: SPORLAND 50-250tons 8: CAREL E2V**P 9: CAREL E2V 10: DANFOSS ETS-25/50 11: DANFOSS ETS-100 12: DANFOSS ETS-250/400 13: CUSTOM 14: ALCO EX8 500 step/s	75	R

Type of gas 0: Not used 1: R22 2: R134a 3: R404a 4: R407c 5: R410a 6: R507c 7: R290 8: R600 9: R600a 10: R717 11: R744 12: R728 13: R1270	76	R
Driver 1 operating mode 0: cool 1: heat 2: defrost	77	R
Driver 2 operating mode 0: cool 1: heat 2: defrost	78	R
Driver 1 position	79	R
Driver 2 position	80	R
Prevent output delay	81	R/W
Type of control probe for heat recovery 0: --- 1: Internal temperature 2: Supply temperatura 3: Internal entalpy	82	R/W
Defrost start delay (heat recovery)	83	R/W
Rotary heat recovery unit – rotor speed during defrost	84	R/W
Rotary heat recovery unit – minimum rotor speed	85	R/W
Cross-flow heat recovery unit – minimum bypass damper opening	86	R/W
Type of cooling/heating selection 0: PANEL (and supervisory BMS) 1: REMOTE 2: AUTOMATIC	87	R/W
Type of pCO board 1: pCO1 2: pCO2 3: pCOC 4: pCOxs 5: --- 6: --- 7: pCO3	88	R

CAREL

CAREL S.p.A.

Via dell'Industria, 11 - 35020 Brugine - Padova (Italy)

Tel. (+39) 049.9716611 Fax (+39) 049.9716600

<http://www.carel.com> - e-mail: carel@carel.com

Agenzia