

Standard Modular Chiller HP 1/8 compressors with CAREL driver

Application program for pCO¹, pCO², pCO³, pCO^C and pCO^{XS}.



ENG

User manual

Manual version: 2.6 dated 11/07/08
Program code: FLSTDmMCDE

→ LEGGI E CONSERVA
QUESTE ISTRUZIONI ←
→ READ AND SAVE
THESE INSTRUCTIONS ←



We wish to save you time and money!

We can assure you that the thorough reading of this manual will guarantee correct installation and safe use of the product described.

IMPORTANT WARNINGS



BEFORE INSTALLING OR HANDLING THE DEVICE, PLEASE CAREFULLY READ AND FOLLOW THE INSTRUCTIONS CONTAINED IN THIS MANUAL.

The instrument this software is intended for has been expressly designed to operate without risks for the established purposes, provided that: the software is installed, programmed, used and maintained by qualified personnel in full accordance with the instructions contained in this manual; all conditions specified and contained in the appliance installation and operating manual are met.

Any other use and modification to the appliance not expressly authorised by the manufacturer shall be considered improper. Liability for injuries or damage caused by improper use lies exclusively with the user.

CONTENTS

1.	Introduction	7
1.1	Main new features in version 2.0.....	7
1.2	Introduction and functions performed by the program	7
1.3	Compatible hardware	7
2.	The user terminal	8
2.1	Type and operation.....	8
2.2	LEDs.....	8
2.3	Functions of the buttons	9
3.	pLAN management between boards	11
3.1	How to assign the pLAN addresses	11
4.	Selecting the language	12
5.	Starting for the first time	12
5.1	Switching the unit on/off	12
6.	List of inputs/outputs	13
6.1	Chiller-only units, configuration "0".....	13
6.2	Chiller unit with freecooling, configuration "1".....	14
6.3	Chiller units with heat pump, configuration "2".....	15
6.4	Chiller units with heat pump and total heat recovery, configuration "3" 16	
6.5	Cooling-only condensing units, configuration "4".....	17
6.6	Condensing units with heat pump, configuration "5".....	18
6.7	Chiller-only units, configuration "6".....	19
6.8	Chiller / heat pump units with reversal on water circuit, configuration "7".....	20
6.9	Chiller-only units, configuration "8".....	21
6.10	Chiller units with freecooling, configuration "9".....	22
6.11	Chiller units with heat pump, configuration "10".....	23
6.12	Chiller units with heat pump and total recovery, configuration "11".....	24
6.13	Air/air condensing units, configuration "12".....	25
6.14	Chiller units with heat pump and condenser, configuration "13".....	26
6.15	Chiller-only units, configuration "14".....	27
6.16	Cooling/heating units with reversal on the water circuit, configuration "15".....	28
6.17	Chiller-only units, configuration "16".....	29
6.18	Chiller units with freecooling, configuration "17".....	30
6.19	Chiller units with heat pump, configuration "18".....	31
6.20	Chiller units with heat Pump and total heat recovery, configuration "19".....	32
6.21	Condensing units, configuration "20".....	33
6.22	Condensing units with heat pump, configuration "21".....	34
6.23	Chiller-only units, configuration "22".....	35
6.24	Cooling/heating units with reversal on the water circuit, configuration "23".....	36
6.25	Air/water units with maximum 4 hermetic compressors for PCO ^{XS}	37
7.	List of parameters and default values	38
8.	Screens	45
8.1	List of the screens	45
9.	EVD200 electronic expansion valve	48
9.1	Driver parameters.....	48
9.2	Special "Ignore" function.....	49
10.	Control	50
10.1	Control set point	50
10.2	Temperature control	50
10.3	Inlet temperature control.....	50
10.4	Outlet temperature control.....	51
11.	Compressor control	53
11.1	Enable compressors from the screen.....	53
11.2	Compressor rotation	53
11.3	Compressor times	53
12.	Condensing unit control	55
12.1	Proportional control	55
12.2	Stepped control	56
13.	Control of water/water units with reversal on the water circuit	57
13.1	Cooling / Heating operation.....	57
14.	Pump down	59
15.	Condenser control	60
15.1	Prevent function.....	60
16.	Defrost control for air/water units	61
16.1	Simultaneous global / Simultaneous local.....	61
16.2	Defrosting a circuit with time/temperature control.....	62
16.3	Defrosting a circuit with time/pressure switch control	62

17.	Control of heat recovery units	63
17.1	Recovery priority	63
17.2	Utility priority	63
18.	Freecooling control	64
18.1	Activation of the freecooling function	64
18.2	Freecooling thermostat	64
18.3	Deactivation of the freecooling function	65
18.4	ON/OFF freecooling valve	65
18.5	ON/OFF freecooling valve with stepped condenser control	66
18.6	ON/OFF freecooling valve with condenser control by inverter	67
18.7	0 to 10 V freecooling valve	67
18.8	0 to 10 V freecooling valve with condenser control by steps	67
18.9	0 to 10 V freecooling valve with condenser control by inverter	68
18.10	Proportional + integral control	68
19.	Antifreeze control	69
20.	Pump control	70
20.1	Burst operation	70
20.2	Pump rotation	70
21.	Installation start-up mode	70
22.	Accessory functions	71
22.1	Temperature set point compensation	71
22.2	Time bands	71
22.3	Time bands with different set points	71
23.	Alarms	72
23.1	General description	72
23.2	Table of alarms	73
24.	Alarm log	75
24.1	Basic log	75
24.2	Advanced log	75
25.	Supervisor	76
26.	Other protocols	4
26.1	RS232 protocol (connection via analogue modem)	4
26.2	GSM protocol	4

1. Introduction

1.1 Main new features in version 2.0

New functions:

1. Implemented compatibility with pCO³;
2. improved management of customised rotation;
3. burst pumps function;
4. automatic cooling/heating changeover.

1.2 Introduction and functions performed by the program

Type of units controlled

Cooling only condensing unit	Condensing unit with heat pump
Air / water chiller only	Air / water chiller + freecooling
Air / water total recovery	Air / water chiller + heat pump
Air / water chiller only	Air / water chiller + heat pump (reversal on water circ.).

Type of control

- Proportional or proportional + integral control on evaporator water inlet temperature probe.
- Dead zone control by time on evaporator water outlet probe

Type of compressors

From 1 to 8	Tandem hermetic compressors	4 compressors for each pCO* board, excluding pCOXS
From 1 to 8	Semi-hermetic compressors with max. 1 load step	2 compressors for each pCO* board, excluding pCOXS
From 1 to 4	Semi-hermetic compressors with max. 3 load steps	1 compressor for each pCO* board, excluding pCOXS

Rotation of compressor calls

- Rotation with FIFO logic, LIFO logic, based on the operating hours of each compressor, custom (logic set by the user)

Condenser control

- Condenser control according to temperature or pressure
- Fans can be managed in ON/OFF mode or by a 0 to 10 V modulating signal.

Type of defrost

- Global defrosting of all the pCO* units connected to the network: Independent / Simultaneous / Separate.
- Local defrosting of the individual pCO* unit: Separate / Simultaneous

Safety devices on each refrigerant circuit

- High pressure (pressure switch/transducer)
- Low pressure (pressure switch)
- Differential oil pressure switch
- Compressor thermal overload
- Condenser fan thermal overload.

System safety devices

- Serious alarm input (stops the whole unit), available on both MASTER and SLAVE units
- Flow switch (stops the whole unit), available on both MASTER and SLAVE units
- Pump thermal overload (stops the whole unit)
- Remote on/off input without alarm signal

Other functions

- Multi-language management (Italian, English, German, French)
- Alarm logging
- Management of pGD0*, external and built-in LCD terminals (on pCO²/pCO³ and pCO^{XS})
- Management of ratiometric probe for pressure control (on pCO¹/pCO³ and pCO^{XS})
- Management of a phase control inverter (on pCO¹ and pCO^{XS})
- EVD driver for electronic valve control
- Time band management with change of set point or ON/OFF, and Management of set point compensation based on the outside temperature
- Management of GSM and analogue modems, and Management of pump rotation
- Management of fan coil enabling signal.

1.3 Compatible hardware

The program is compatible with the following devices:

- pCO^{XS}, codes PCO100*;
- pCO¹ MEDIUM, codes PCO100*;
- pCO² MEDIUM codes PCO200*;
- pCO³ MEDIUM,
- PCOT* 4x20 LCD for panel installation and wall mounting;
- PCO* 4x20 LCD for panel installation;
- PGD0* semi-graphic display;
- built-in LCD on the pCO^{XS} and pCO², pCO³ boards.

Accessories: Supervision with RS422 or RS485 serial board.

WARNINGS: the information contained in this manual is valid starting from version 2.0 of the application program. Starting from version 1.0, this application program is not compatible with BIOS previous versions lower than 3.45 and BOOT versions lower than 3.01.

2. The user terminal

2.1 Type and operation

Three types of terminal are envisaged:

1. PGD0/semi-graphic/6 buttons/4 rows - 20 columns/connection with telephone cable
2. LCD/15 buttons/4 rows - 20 columns/connection with telephone cable
3. Built-in/6 buttons/4 rows - 20 columns (pCO²- pCO³ only)/display on board

The user terminal can be used to perform all the operations allowed by the program, display the operating conditions of the unit at all times, and set the parameters. It can be disconnected from the main board, and in fact is not required for operation.

2.2 LEDs

2.2.1 PGD0 terminal with 6 buttons

LED	Colour	Description
 button (Alarm)	Red	On – One or more active alarm conditions
Prg button	Yellow	On – Unit on Flashing – Unit off from supervisor or digital input

All the LEDs not described and located underneath the remaining 4 buttons indicate the correct power supply to the instrument. Together with the backlighting on the display, these will be switched off if no button is pressed on the keypad for 5 minutes.

2.2.2 LCD terminal with 15 buttons

Each button has a green LED indicating the specific group of parameters selected during the operations to display/modify the operating parameters. The silicone rubber buttons have three different coloured LEDs, whose meaning is specified in the following table

LED	Colour	Description
[On/Off] button	Green	On – Unit on Flashing – Unit off from supervisor or digital input
 button (Alarm)	Red	On – One or more active alarm conditions
[↵] button (Enter)	Yellow	On – Instrument correctly powered

2.2.3 Built-In terminal with 6 buttons

Given the number of buttons and LEDs available, these have general meanings, as described below:

LED	Colour	Description
 button (Alarm)	Red	On – One or more active alarm conditions
[↵] button (Enter)	Yellow	On – Unit on Flashing – Unit off from supervisor or digital input
[Prg] button	Green	On – Displaying/modifying the operating parameters
[Esc] button	Green	On – Main menu parameters displayed

2.3 Functions of the buttons

2.3.1 PGD0 terminal with 6 buttons

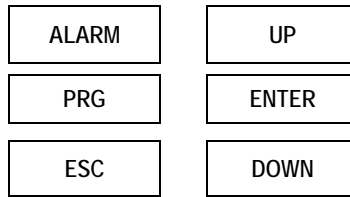
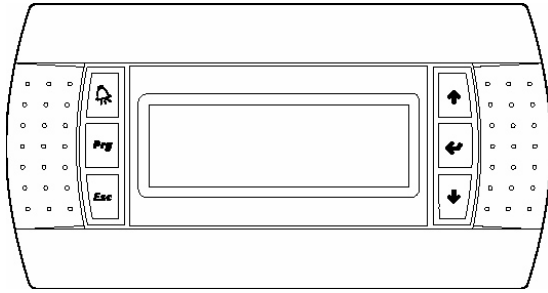



Button	Description
ALARM	displays the alarms, mutes the buzzer and deletes the active alarms
UP	if the cursor is in the home position (top left corner), scrolls up the screens in the same group; if the cursor is in a setting field, increases the value
DOWN	if the cursor is in the home position (top left corner), scrolls down the screens in the same group; if the cursor is in a setting field, decreases the value
ENTER	used to move the cursor from the home position (top left corner) to the setting fields, in the setting fields confirms the set value and moves to the next parameter
PRG	accesses the menu for selecting the group of parameters to be displayed/modified (access to the parameters is confirmed by pressing the [Enter] button)
PRG + ENTER	temporarily display the pLAN serial address of the board
ESC + ENTER	pressed at the same time for 20 seconds access the screen for switching the unit On/Off

2.3.2 pGD0 terminal with 15 buttons



Button	Description
	MENU From any point of the user interface (with the exception of the manufacturer group of parameters) returns to the Main menu screen (M0) displaying the unit status, readings of the control probes and operating mode. In the group of manufacturer parameters, organised into nested sub-groups, returns to screen for selecting the parameters.
	MAINTENANCE Goes to the first screen of Maintenance parameters (A0) The Maintenance parameters are used to check the operating status of devices and the probes, calibrate the readings and run manual operations
	PRINTER Temporarily display the pLAN serial address of the board
	INPUTS AND OUTPUTS Goes to the first screen of I/O parameters (I0) The I/O parameters display the status of the inputs and the outputs on the board
	CLOCK Goes to the first screen of Clock parameters (K0) The Clock parameters are used to display/set the operating parameters for the clock board and activate the time bands
	SET POINT Goes to the first screen of Set point parameters (S0). The Set point parameters are used to display/modify the unit working set point within the limits defined in the configuration
	PROGRAM Goes to the screen for entering the user password (P0) The user parameters are used to modify the unit operating mode
	MENU+PROG Goes to the screen for entering the manufacturer password (Z0) The manufacturer parameters are used to configure the unit in terms of the number and type of devices connected, enable specific accessories or special functions
	INFO In pLAN applications with more than one board connected in the network and a shared user terminal, switches the user terminal between the different units to display/modify the parameters

Button	Description	
	RED	with the unit off enables heating management in the unit configurations where chiller / heat pump operation is envisaged.
	BLUE	with the unit off enables cooling management in the unit configurations where chiller / heat pump operation is envisaged

Silicone rubber buttons



Button	Description	
1	ON/OFF	switches the unit on/off
2	ALARM	displays the alarms, mutes the buzzer and deletes the active alarms
3	UP ARROW	if the cursor is in the home position (top left corner), scrolls up the screens in the same group; if the cursor is in a setting field, increases the value
4	DOWN ARROW	if the cursor is in the home position (top left corner), scrolls down the screens in the same group; if the cursor is in a setting field, decreases the value
5	ENTER	used to move the cursor from the home position (top left corner) to the setting fields, in the setting fields confirms the set value and moves to the next parameter

2.3.3 Built-In terminal with 6 buttons



ALARM	PRG	ESC
-------	-----	-----

DOWN	UP	ENTER
------	----	-------

Button	Description
ALARM	displays the alarms, mutes the buzzer and deletes the active alarms
UP	if the cursor is in the home position (top left corner), scrolls up the screens in the same group; if the cursor is in a setting field, increases the value
DOWN	if the cursor is in the home position (top left corner), scrolls down the screens in the same group; if the cursor is in a setting field, decreases the value
ENTER	used to move the cursor from the home position (top left corner) to the setting fields, in the setting fields confirms the set value and moves to the next parameter
PRG	accesses the menu for selecting the group of parameters to be displayed/modified (access to the parameters is confirmed by pressing the [Enter] button)
PRG + ENTER	temporary display of the board pLAN serial address
ESC + ENTER	pressed at the same time for 20 seconds access the screen for switching the unit On/Off

3. pLAN management between boards

The pLAN network identifies a physical connection between the boards (pCO¹, pCO², pCO³) and the external terminals.

pLAN= CO Local Area Network. The purpose of the pLAN network connection between the boards is to exchange variables, according to the logic decided by the program, so as the units can operate together.

The variables exchanged between the boards are established by the program, as is the direction of exchange, and therefore there are no user settings; the only operation required by the user involves the electrical connections.

Below is a diagram with all the components connected in the pLAN:

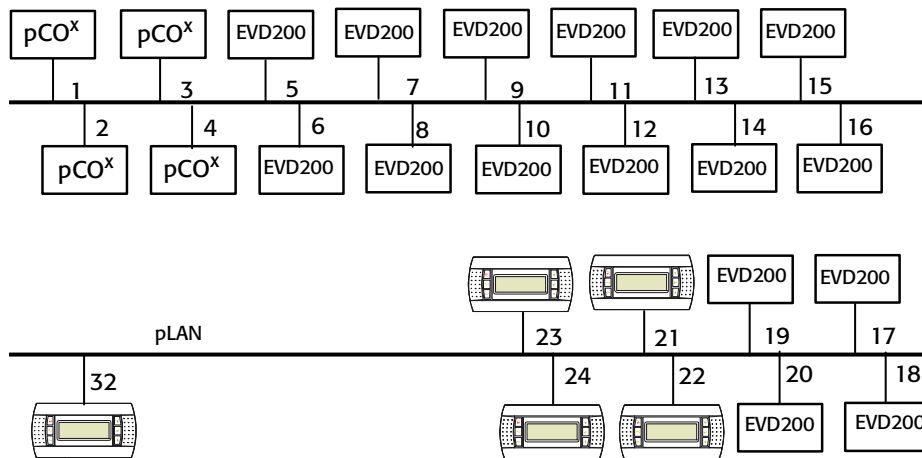

The main screen M0 shows the address of the board connected in the bottom left corner. The terminal with address 32 can display all the boards without needing the other terminals.

	pCO	TERMINAL	EVD200 cool heat	EVD200 heat
UNIT 1	1	21	5-7	6-8
UNIT 2	2	22	9-11	10-12
UNIT 3	3	23	13-15	14-16
UNIT 4	4	24	17-19	18-20

3.1 How to assign the pLAN addresses

The pLAN addresses must be unique and set according to the figure shown above. There are various methods for assigning the pLAN address.

3.1.1 PGD0 terminal

To set the address of a PGD terminal (the default value is 32), proceed as follows:

1. Power up the terminal
2. Press the Up + Down + Enter buttons until the "display address setting" screen is displayed
3. Enter the numeric pLAN address with the Up and Down buttons and then confirm by pressing Enter
4. The "No link" screen will be displayed
5. If the "No Link" screen is not displayed, press Up + Down + Enter again
6. Once the "display address setting" screen is displayed, press Enter 3 times

When the "adr Priv/shard" screen is displayed, set the correct values and confirm with "YES"

3.1.2 Setting the address on the pCO¹- pCO³

Description of the operations to be completed for setting the pLAN address on the pCO¹ and pCO³ boards:

1. Power down the pCO* board and connect a 4x20 LCD terminal / PGD0 terminal with pLAN address "0".
2. Power up the pCO* board, by holding the Alarm + Up buttons until a screen appears.
3. When the "pLAN Address" screen is shown, follow the operations shown, i.e. enter the number (1,2,3...) of the pLAN address with the Up and Down buttons and then confirm by pressing Enter.
4. Power down the pCO* board.
5. If necessary, assign the correct pLAN address to the external terminal.
6. Power up the pCO* board.
7. Configure the pCO* to communicate speak with the terminal, if necessary (see points 5 and 6 in par. 3.1.1).

3.1.3 Setting the address on the pCO², PCOI/PCOT terminals and EVD-200 valve drivers

The pLAN addresses on these units are set with binary logic by changing the position of a set of dipswitches located on the rear of the pCOI / PCOT terminals, on the pCO² boards and inside the EVD-200 electronic valve drivers. This must be done with all the devices off. For further information, see the specific manual for the device.

In all the other screens in the program, to display the address of the board that is currently connected, press the printer button or Prg+Enter, depending on the terminal used.

4. Selecting the language

When the unit is started, as default a screen is displayed where the language to be used can be selected. This screen remains active for 30 seconds, after which the application automatically skips to the main menu (screen M0). This function can be deactivated. To do this simply :

1. Go to the Program branch (screen P0)
2. Set the correct password.
3. Go to the Various parameters sub-branch
4. Press the down arrow button until reaching screen "R9"
5. Choose "N" for the item "Display language screen" on power-up.

In any case, the language can be changed at any time. To do this, simply go to screen "A2" in the "MAINT" branch.

5. Starting for the first time

After having checked the connections between the various boards and terminals, power up the pCO* board/boards. On power-up, the software automatically installs the default values chosen by CAREL for the chiller and driver configuration parameters. This section explains how to restore the default values and to return to the starting conditions. When starting for the first time, this operation is not required.

The following procedure is used to restore all the configuration parameters to the default values selected by CAREL.

CAUTION! this procedure irreversibly deletes any programming performed by the user.

As resetting the default values is an operation that involves each pCO* board, when more than one board is present, the procedure must be repeated for the all the boards. The procedure is identical for all the boards. Proceed as follows:

- press the "menu" and "prog" buttons on the LCD terminal at the same time (go to the manufacturer branch on the PGD0 terminal). When pressed, the LEDs corresponding to the "menu" and "prog" buttons will come on;
- enter the password using the "arrow" buttons and press enter : scroll the menu and enter the initialisation submenu.

```
+-----+
|Insert      Z0|
|manufactory |
|password    |
|           0000|
+-----+
```

- enter the "Initialisation" branch from the default installation screen:

```
+-----+
|Reset all   V0|
|parameters |
|to default values N|
|Please wait...|
+-----+
```

- press the "enter" button so as to position the cursor over the letter "N", and using the arrow buttons change this to "Y"; the message "please wait..." will appear; after a few seconds this disappears: at this stage, the default values have been installed completely.

5.1 Switching the unit on/off

There are two ways of switching the unit on/off:

1. System On/Off
2. Circuit On/Off

The unit status can be controlled from the keypad, digital input (this function can be enabled) and supervisor (this function can be enabled)

Switching the unit on/off from the keypad using the ON/OFF button has priority over the other modes; when pressing the button the corresponding green LED will be switched on/off, depending on the status. With the PGD0 or Built-in terminal, press "PRG", scroll the menu to "Unit ON-OFF", press "ENTER" to enter screen M2 and then switch the unit on/off.

The unit can be switched on/off from the supervisor and/or digital input only if switched on from the keypad; switching the unit off from the supervisor and/or digital input is signalled by the flashing of the green LED corresponding to the ON/OFF button and by a special message on the main menu screen.

System On/Off

This function is performed by the master board: if on, all the slaves making up the system can also be switched on, vice-versa if off.

Circuit On/Off

This function is performed by each slave board: only if the master board is on can the individual slave boards be switched on/off by the supervisor.

When the system is first started, make sure that all the boards are on, querying them from the shared terminal. To do this, refer to the paragraph on the "USER TERMINAL", which describes the meaning of the various buttons and LEDs on the keypad used.

6. List of inputs/outputs

Following is a list of the inputs and outputs for each the type of unit; each unit type has been given a number. This number is the main parameter of the program, and can be selected in the manufacturer menu.

6.1 Chiller-only units, configuration "0"

AIR/WATER units with maximum 8 tandem hermetic compressors.

DIGITAL INPUTS

No.	pCO ² /pCO ³ MEDIUM		pCO ¹ MEDIUM		pCO ^c MEDIUM	
	Master (address 1)	Slaves (address 2)	Master (address 1)	Slaves (address 2)	Master (address 1)	Slaves (address 2)
ID 1	Serious alarm	Serious alarm (can be enabled)	Serious alarm	Serious alarm (can be enabled)	Serious alarm	Serious alarm (can be enabled)
ID 2	Evaporator flow switch	Evap. flow switch (can be enabled)	Evaporator flow switch	Evap. flow switch (can be enabled)	Evaporator flow switch	Evap. flow switch (can be enabled)
ID 3	Remote ON/OFF		Remote ON/OFF		Remote ON/OFF	
ID 4	Pump thermal overload	Pump 2 thermal overload	Pump thermal overload	Pump 2 thermal overload	Pump thermal overload	
ID 5	Low press. switch 1	Low press. switch 3	Low press. switch 1	Low press. switch 3	Low press. switch 1	Low press. switch 3
ID 6	Comp. 1 thermal overload	Comp. 5 thermal overload	Comp. 1 thermal overload	Comp. 5 thermal overload	Comp. 1 thermal overload	Comp. 5 thermal overload
ID 7	Comp. 2 thermal overload	Comp. 6 thermal overload	Comp. 2 thermal overload	Comp. 6 thermal overload	Comp. 2 thermal overload	Comp. 6 thermal overload
ID 8	Low press. switch 2	Low press. switch 4	Low press. switch 2	Low press. switch 4	Low press. switch 2	Low press. switch 4
ID 9	Comp. 3 thermal overload	Comp. 7 thermal overload	Comp. 3 thermal overload	Comp. 7 thermal overload	Comp. 3 thermal overload	Comp. 7 thermal overload
ID10	Comp. 4 thermal overload	Comp. 8 thermal overload	Comp. 4 thermal overload	Comp. 8 thermal overload	Comp. 4 thermal overload	Comp. 8 thermal overload
ID11					High press. switch 1	High press. switch 3
ID12					High press. switch 2	High press. switch 4
ID13	High press. switch 1	High press. switch 3	High press. switch 1	High press. switch 3		
ID14	High press. switch 2	High press. switch 4	High press. switch 2	High press. switch 4		

ANALOGUE INPUTS

No.	pCO ² /pCO ³ MEDIUM		pCO ¹ MEDIUM		pCO ^c MEDIUM	
	Master (address 1)	Slaves (address 2)	Master (address 1)	Slaves (address 2)	Master (address 1)	Slaves (address 2)
B1	Cond. temp. circuit 1	Cond. temp. circuit 3	Outside set point		Water inlet temp.	
B2	Cond. temp. circuit 2	Cond. temp. circuit 4			Water outlet temp. 1	Water outlet temp. 2
B3	Outside set point		High pressure circuit 1	High pressure circuit 3	Cond. temp. circuit 1	Cond. temp. circuit 3
B4	Water inlet temp.		High pressure circuit 2	High pressure circuit 4	Cond. temp. circuit 2	Cond. temp. circuit 4
B5	Water outlet temp. 1	Water outlet temp. 2	Water inlet temp.		Outside set point	
B6			Water outlet temp. 1	Water outlet temp. 2		
B7	High pressure circuit 1	High pressure circuit 3	Cond. temp. circuit 1	Cond. temp. circuit 3	High pressure circuit 1	High pressure circuit 3
B8	High pressure circuit 2	High pressure circuit 4	Cond. temp. circuit 2	Cond. temp. circuit 4	High pressure circuit 2	High pressure circuit 4

DIGITAL OUTPUTS

No.	pCO ² /pCO ³ MEDIUM		pCO ¹ MEDIUM		pCO ^c MEDIUM	
	Master (address 1)	Slaves (address 2)	Master (address 1)	Slaves (address 2)	Master (address 1)	Slaves (address 2)
NO1	Compressor 1	Compressor 5	Compressor 1	Compressor 5	Evap. pump 1	
NO2	Compressor 2	Compressor 6	Compressor 2	Compressor 6	Compressor 1	Compressor 5
NO3	Liq. solenoid circuit 1	Liq. solenoid circuit 3	Liq. solenoid circuit 1	Liq. solenoid circuit 3	Compressor 2	Compressor 6
NO 4	Compressor 3	Compressor 7	Compressor 3	Compressor 7	Liq. solenoid circuit 1	Liq. solenoid circuit 3
NO 5	Compressor 4	Compressor 8	Compressor 4	Compressor 8		
NO 6	Liq. solenoid circuit 2	Liq. solenoid circuit 4	Liq. solenoid circuit 2	Liq. solenoid circuit 4	Compressor 3	Compressor 7
NO 7	Evap. pump 1	Evap. pump 2. / Disable fan coil	Evap. pump 1	Evap. pump 2. / Disable fan coil	Compressor 4	Compressor 8
NO 8	General alarm	General alarm	General alarm	General alarm	Liq. solenoid circuit 2	Liq. solenoid circuit 4
NO 9	Cond. fan 1 circuit 1	Cond. fan 1 circuit 3	Cond. fan 1 circuit 1	Cond. fan 1 circuit 3		
NO10	Cond. fan 1 circuit 2 or Cond. fan 2 circuit 1	Cond. fan 1 circuit 4 or Cond. fan 2 circuit 3	Cond. fan 1 circuit 2 or Cond. fan 2 circuit 1	Cond. fan 1 circuit 4 or Cond. fan 2 circuit 3	Antifreeze heater 1	Antifreeze heater 2
NO11	Antifreeze heater 1	Antifreeze heater 2	Antifreeze heater 1	Antifreeze heater 2	General alarm	General alarm
NO12					Cond. fan 1 circuit 1	Cond. fan 1 circuit 3
NO13					Cond. fan 1 circuit 2 or Cond. fan 2 circuit 1	Cond. fan 1 circuit 4 or Cond. fan 2 circuit 3

ANALOGUE OUTPUTS

No.	pCO ² /pCO ³ MEDIUM		pCO ¹ MEDIUM		pCO ^c MEDIUM	
	Master (address 1)	Slaves (address 2)	Master (address 1)	Slaves (address 2)	Master (address 1)	Slaves (address 2)
Y1					Cond. fan 1 inverter	Cond. fan 3 inverter
Y2					Cond. fan 2 inverter	Cond. fan 4 inverter
Y3	Cond. fan 1 inverter	Cond. fan 3 inverter	Cond. fan 1 inverter	Cond. fan 3 inverter		
Y4	Cond. fan 2 inverter	Cond. fan 4 inverter	Cond. fan 2 inverter	Cond. fan 4 inverter		

6.2 Chiller unit with freecooling, configuration "1"

AIR/WATER units with maximum 8 tandem hermetic compressors.

DIGITAL INPUTS

No.	pCO ² /pCO ³ MEDIUM		pCO ¹ MEDIUM		pCO ^c MEDIUM	
	Master (address 1)	Slave (address 2)	Master (address 1)	Slave (address 2)	Master (address 1)	Slave (address 2)
ID 1	Serious alarm	Serious alarm (can be enabled)	Serious alarm	Serious alarm (can be enabled)	Serious alarm	Serious alarm (can be enabled)
ID 2	Evaporator flow switch	Evap. flow switch (can be enabled)	Evaporator flow switch	Evap. flow switch (can be enabled)	Evaporator flow switch	Evap. flow switch (can be enabled)
ID 3	Remote ON/OFF		Remote ON/OFF		Remote ON/OFF	
ID 4	Pump 1 thermal overload	Pump 2 thermal overload	Pump thermal overload	Pump 2 thermal overload	Pump thermal overload	
ID 5	Low press. switch 1	Low press. switch 3	Low press. switch 1	Low press. switch 3	Low press. switch 1	Low press. switch 3
ID 6	Comp. 1 thermal overload	Comp. 5 thermal overload	Comp. 1 thermal overload	Comp. 5 thermal overload	Comp. 1 thermal overload	Comp. 5 thermal overload
ID 7	Comp. 2 thermal overload	Comp. 6 thermal overload	Comp. 2 thermal overload	Comp. 6 thermal overload	Comp. 2 thermal overload	Comp. 6 thermal overload
ID 8	Low press. switch 2	Low press. switch 4	Low press. switch 2	Low press. switch 4	Low press. switch 2	Low press. switch 4
ID 9	Comp. 3 thermal overload	Comp. 7 thermal overload	Comp. 3 thermal overload	Comp. 7 thermal overload	Comp. 3 thermal overload	Comp. 7 thermal overload
ID10	Comp. 4 thermal overload	Comp. 8 thermal overload	Comp. 4 thermal overload	Comp. 8 thermal overload	Comp. 4 thermal overload	Comp. 8 thermal overload
ID11					High press. switch 1	High press. switch 3
ID12					High press. switch 2	High press. switch 4
ID13	High press. switch 1	High press. switch 3	High press. switch 1	High press. switch 3		
ID14	High press. switch 2	High press. switch 4	High press. switch 2	High press. switch 4		

ANALOGUE INPUTS

No.	pCO ² /pCO ³ MEDIUM		pCO ¹ MEDIUM		pCO ^c MEDIUM	
	Master (address 1)	Slave (address 2)	Master (address 1)	Slave (address 2)	Master (address 1)	Slave (address 2)
B1	Cond. temp. circuit 1	Cond. temp. circuit 3	Outside temperature		Water inlet temp.	
B2	Cond. temp. circuit 2	Cond. temp. circuit 4	Freecooling temperature		Water outlet temp. 1	Water outlet temp. 2
B3	Outside temperature		High pressure circuit 1	High pressure circuit 3	Cond. temp. circuit 1	Cond. temp. circuit 3
B4	Water inlet temp.		High pressure circuit 2	High pressure circuit 4	Cond. temp. circuit 2	Cond. temp. circuit 4
B5	Water outlet temp. 1	Water outlet temp. 2	Water inlet temp.		Outside temperature	
B6	Freecooling temperature		Water outlet temp. 1	Water outlet temp. 2	Freecooling temperature	
B7	High pressure circuit 1	High pressure circuit 3	Cond. temp. circuit 1	Cond. temp. circuit 3	High pressure circuit 1	High pressure circuit 3
B8	High pressure circuit 2	High pressure circuit 4	Cond. temp. circuit 2	Cond. temp. circuit 4	High pressure circuit 2	High pressure circuit 4

DIGITAL OUTPUTS

No.	pCO ² MEDIUM		pCO ¹ MEDIUM		pCO ^c MEDIUM	
	Master (address 1)	Slave (address 2)	Master (address 1)	Slave (address 2)	Master (address 1)	Slave (address 2)
NO1	Compressor 1	Compressor 5	Compressor 1	Compressor 5	Evap. pump 1	
NO2	Compressor 2	Compressor 6	Compressor 2	Compressor 6	Compressor 1	Compressor 5
NO3	Liq. solenoid circuit 1	Liq. solenoid circuit 3	Liq. solenoid circuit 1	Liq. solenoid circuit 3	Compressor 2	Compressor 6
NO4	Compressor 3	Compressor 7	Compressor 3	Compressor 7	Liq. solenoid circuit 1	Liq. solenoid circuit 3
NO5	Compressor 4	Compressor 8	Compressor 4	Compressor 8		
NO6	Liq. solenoid circuit 2	Liq. solenoid circuit 4	Liq. solenoid circuit 2	Liq. solenoid circuit 4	Compressor 3	Compressor 7
NO7	Evap. pump 1	Evap. pump 2. / Disable fan coil	Evap. pump 1	Evap. pump 2. / Disable fan coil	Compressor 4	Compressor 8
NO8	General alarm	General alarm	General alarm	General alarm	Liq. solenoid circuit 2	Liq. solenoid circuit 4
NO9	Cond. fan 1 circuit 1	Cond. fan 1 circuit 3	Cond. fan 1 circuit 1	Cond. fan 1 circuit 3	Cond. fan 1 circuit 2 or Cond. fan 2 circuit 1	Cond. fan 1 circuit 4 or Cond. fan 2 circuit 3
NO10	ON/OFF freecooling valve	Cond. fan 1 circuit 4 or Cond. fan 2 circuit 3	ON/OFF freecooling valve	Cond. fan 1 circuit 4 or Cond. fan 2 circuit 3	Antifreeze heater 1	Antifreeze heater 2
NO11	Antifreeze heater 1	Antifreeze heater 2	Antifreeze heater 1	Antifreeze heater 2	General alarm	General alarm
NO12					Cond. fan 1 circuit 1	Cond. fan 1 circuit 3
NO13	Cond. fan 1 circuit 2 or Cond. fan 2 circuit 1	Cond. fan 1 circuit 4 or Cond. fan 2 circuit 3	Cond. fan 1 circuit 2 or Cond. fan 2 circuit 1	Cond. fan 1 circuit 4 or Cond. fan 2 circuit 3	ON/OFF freecooling valve	Cond. fan 1 circuit 4 or Cond. fan 2 circuit 3

ANALOGUE OUTPUTS

No.	pCO ² /pCO ³ MEDIUM		pCO ¹ MEDIUM		pCO ^c MEDIUM	
	Master (address 1)	Slave (address 2)	Master (address 1)	Slave (address 2)	Master (address 1)	Slave (address 2)
Y1	Modul. freecooling valve		Modul. freecooling valve		Cond. fan 1 inverter	Cond. fan 3 inverter
Y2					Modul. freecooling valve	Cond. fan 4 inverter
Y3	Cond. fan 1 inverter	Cond. fan 3 inverter	Cond. fan 1 inverter	Cond. fan 3 inverter		
Y4	Cond. fan 2 inverter	Cond. fan 4 inverter	Cond. fan 2 inverter	Cond. fan 4 inverter		

6.3 Chiller units with heat pump, configuration "2"

AIR/WATER units with maximum 8 tandem hermetic compressors.

DIGITAL INPUTS

No.	pCO ² /pCO ³ MEDIUM		pCO ¹ MEDIUM		pCO ^c MEDIUM	
	Master (address 1)	Slave (address 2)	Master (address 1)	Slave (address 2)	Master (address 1)	Slave (address 2)
ID 1	Serious alarm	Serious alarm (can be enabled)	Serious alarm	Serious alarm (can be enabled)	Serious alarm	Serious alarm (can be enabled)
ID 2	Evaporator flow switch	Evap. flow switch (can be enabled)	Evaporator flow switch	Evap. flow switch (can be enabled)	Evaporator flow switch	Evap. flow switch (can be enabled)
ID 3	Remote ON/OFF		Remote ON/OFF		Remote ON/OFF	
ID 4	Pump 1 thermal overload	Pump 2 thermal overload	Pump 1 thermal overload	Pump 2 thermal overload	Cooling/heating selection	
ID 5	Low press. switch 1	Low press. switch 3	Low press. switch 1	Low press. switch 3	Low press. switch 1	Low press. switch 3
ID 6	Comp. 1 thermal overload	Comp. 5 thermal overload	Comp. 1 thermal overload	Comp. 5 thermal overload	Comp. 1 thermal overload	Comp. 5 thermal overload
ID 7	Comp. 2 thermal overload	Comp. 6 thermal overload	Comp. 2 thermal overload	Comp. 6 thermal overload	Comp. 2 thermal overload	Comp. 6 thermal overload
ID 8	Low press. switch 2	Low press. switch 4	Low press. switch 2	Low press. switch 4	Low press. switch 2	Low press. switch 4
ID 9	Comp. 3 thermal overload	Comp. 7 thermal overload	Comp. 3 thermal overload	Comp. 7 thermal overload	Comp. 3 thermal overload	Comp. 7 thermal overload
ID10	Comp. 4 thermal overload	Comp. 8 thermal overload	Comp. 4 thermal overload	Comp. 8 thermal overload	Comp. 4 thermal overload	Comp. 8 thermal overload
ID11	Cooling/heating selection		Cooling/heating selection		High press. switch 1	High press. switch 3
ID12					High press. switch 2	High press. switch 4
ID13	High press. switch 1	High press. switch 3	High press. switch 1	High press. switch 3		
ID14	High press. switch 2	High press. switch 4	High press. switch 2	High press. switch 4		

ANALOGUE INPUTS

No.	pCO ² /pCO ³ MEDIUM		pCO ¹ MEDIUM		pCO ^c MEDIUM	
	Master (address 1)	Slave (address 2)	Master (address 1)	Slave (address 2)	Master (address 1)	Slave (address 2)
B1	Cond. temp. circuit 1	Cond. temp. circuit 3	Outside set point		Water inlet temp.	
B2	Cond. temp. circuit 2	Cond. temp. circuit 4			Water outlet temp. 1	Water outlet temp. 2
B3	Outside set point		High pressure circuit 1	High pressure circuit 3	Cond. temp. circuit 1	Cond. temp. circuit 3
B4	Water inlet temp.		High pressure circuit 2	High pressure circuit 4	Cond. temp. circuit 2	Cond. temp. circuit 4
B5	Water outlet temp. 1	Water outlet temp. 2	Water inlet temp.		Outside set point	
B6			Water outlet temp. 1	Water outlet temp. 2		
B7	High pressure circuit 1	High pressure circuit 3	Cond. temp. circuit 1	Cond. temp. circuit 3	High pressure circuit 1	High pressure circuit 3
B8	High pressure circuit 2	High pressure circuit 4	Cond. temp. circuit 2	Cond. temp. circuit 4	High pressure circuit 2	High pressure circuit 4

DIGITAL OUTPUTS

No.	pCO ² /pCO ³ MEDIUM		pCO ¹ MEDIUM		pCO ^c MEDIUM	
	Master (address 1)	Slave (address 2)	Master (address 1)	Slave (address 2)	Master (address 1)	Slave (address 2)
NO1	Compressor 1	Compressor 5	Compressor 1	Compressor 5	Evap. pump 1	
NO2	Compressor 2	Compressor 6	Compressor 2	Compressor 6	Compressor 1	Compressor 5
NO3	Liq. solenoid circuit 1	Liq. solenoid circuit 3	Liq. solenoid circuit 1	Liq. solenoid circuit 3	Compressor 2	Compressor 6
NO 4	Compressor 3	Compressor 7	Compressor 3	Compressor 7	Liq. solenoid circuit 1	Liq. solenoid circuit 3
NO 5	Compressor 4	Compressor 8	Compressor 4	Compressor 8	4-way valve circuit 1	4-way valve circuit 3
NO 6	Liq. solenoid circuit 2	Liq. solenoid circuit 4	Liq. solenoid circuit 2	Liq. solenoid circuit 4	Compressor 3	Compressor 7
NO 7	Evap. pump 1	Evap. pump 2. / Disable fan coil	Evap. pump 1	Evap. pump 2. / Disable fan coil	Compressor 4	Compressor 8
NO 8	General alarm	General alarm	General alarm	General alarm	Liq. solenoid circuit 2	Liq. solenoid circuit 4
NO 9	Cond. fan 1 circuit 1	Cond. fan 1 circuit 3	Cond. fan 1 circuit 1	Cond. fan 1 circuit 3	4-way valve circuit 2	4-way valve circuit 4
NO10	Cond. fan 1 circuit 2 or Cond. fan 2 circuit 1	Cond. fan 1 circuit 4 or Cond. fan 2 circuit 3	Cond. fan 1 circuit 2 or Cond. fan 2 circuit 1	Cond. fan 1 circuit 4 or Cond. fan 2 circuit 3	Antifreeze heater 1	Antifreeze heater 2
NO11	Antifreeze heater 1	Antifreeze heater 2	Antifreeze heater 1	Antifreeze heater 2	General alarm	General alarm
NO12	4-way valve circuit 1	4-way valve circuit 3	4-way valve circuit 1	4-way valve circuit 3	Cond. fan 1 circuit 1	Cond. fan 1 circuit 3
NO13	4-way valve circuit 2	4-way valve circuit 4	4-way valve circuit 2	4-way valve circuit 4	Cond. fan 1 circuit 2 or Cond. fan 2 circuit 1	Cond. fan 1 circuit 4 or Cond. fan 2 circuit 3

ANALOGUE OUTPUTS

No.	pCO ² /pCO ³ MEDIUM		pCO ¹ MEDIUM		pCO ^c MEDIUM	
	Master (address 1)	Slave (address 2)	Master (address 1)	Slave (address 2)	Master (address 1)	Slave (address 2)
Y1					Cond. fan 1 inverter	Cond. fan 3 inverter
Y2					Cond. fan 2 inverter	Cond. fan 4 inverter
Y3	Cond. fan 1 inverter	Cond. fan 3 inverter	Cond. fan 1 inverter	Cond. fan 3 inverter		
Y4	Cond. fan 2 inverter	Cond. fan 4 inverter	Cond. fan 2 inverter	Cond. fan 4 inverter		

6.4 Chiller units with heat pump and total heat recovery, configuration "3"

AIR/WATER units with maximum 8 tandem hermetic compressors.

DIGITAL INPUTS

No.	pCO ² /pCO ³ MEDIUM		pCO ¹ MEDIUM		pCO ^c MEDIUM	
	Master (address 1)	Slave (address 2)	Master (address 1)	Slave (address 2)	Master (address 1)	Slave (address 2)
ID 1	Serious alarm	Serious alarm (can be enabled)	Serious alarm	Serious alarm (can be enabled)	Serious alarm	Serious alarm (can be enabled)
ID 2	Evaporator flow switch	Evap. flow switch (can be enabled)	Evaporator flow switch	Evap. flow switch (can be enabled)	Evaporator flow switch	Evap. flow switch (can be enabled)
ID 3	Remote ON/OFF		Remote ON/OFF		Remote ON/OFF	
ID 4	Pump 1 thermal overload	Pump 2 thermal overload	Pump 1 thermal overload	Pump 2 thermal overload	Cooling/heating selection	
ID 5	Low press. switch 1	Low press. switch 3	Low press. switch 1	Low press. switch 3	Low press. switch 1	Low press. switch 3
ID 6	Comp. 1 thermal overload	Comp. 5 thermal overload	Comp. 1 thermal overload	Comp. 5 thermal overload	Comp. 1 thermal overload	Comp. 5 thermal overload
ID 7	Comp. 2 thermal overload	Comp. 6 thermal overload	Comp. 2 thermal overload	Comp. 6 thermal overload	Comp. 2 thermal overload	Comp. 6 thermal overload
ID 8	Low press. switch 2	Low press. switch 4	Low press. switch 2	Low press. switch 4	Low press. switch 2	Low press. switch 4
ID 9	Comp. 3 thermal overload	Comp. 7 thermal overload	Comp. 3 thermal overload	Comp. 7 thermal overload	Comp. 3 thermal overload	Comp. 7 thermal overload
ID 10	Comp. 4 thermal overload	Comp. 8 thermal overload	Comp. 4 thermal overload	Comp. 8 thermal overload	Comp. 4 thermal overload	Comp. 8 thermal overload
ID 11	Cooling/heating selection		Cooling/heating selection		High press. switch 1	High press. switch 3
ID 12					High press. switch 2	High press. switch 4
ID 13	High press. switch 1	High press. switch 3	High press. switch 1	High press. switch 3		
ID 14	High press. switch 2	High press. switch 4	High press. switch 2	High press. switch 4		

ANALOGUE INPUTS

No.	pCO ² /pCO ³ MEDIUM		pCO ¹ MEDIUM		pCO ^c MEDIUM	
	Master (address 1)	Slave (address 2)	Master (address 1)	Slave (address 2)	Master (address 1)	Slave (address 2)
B1	Cond. temp. circuit 1	Cond. temp. circuit 3	Recovery inlet temp.		Water inlet temp.	
B2	Cond. temp. circuit 2	Cond. temp. circuit 4	Recovery outlet temp.		Water outlet temp. 1	Water outlet temp. 2
B3	Recovery inlet temp.		High pressure circuit 1	High pressure circuit 3	Cond. temp. circuit 1	Cond. temp. circuit 3
B4	Water inlet temp.		High pressure circuit 2	High pressure circuit 4	Cond. temp. circuit 2	Cond. temp. circuit 4
B5	Water outlet temp. 1	Water outlet temp. 2	Water inlet temp.		Recovery inlet temp.	
B6	Recovery outlet temp.		Water outlet temp. 1	Water outlet temp. 2	Recovery outlet temp.	
B7	High pressure circuit 1	High pressure circuit 3	Cond. temp. circuit 1	Cond. temp. circuit 3	High pressure circuit 1	High pressure circuit 3
B8	High pressure circuit 2	High pressure circuit 4	Cond. temp. circuit 2	Cond. temp. circuit 4	High pressure circuit 2	High pressure circuit 4

DIGITAL OUTPUTS

No.	pCO ² /pCO ³ MEDIUM		pCO ¹ MEDIUM		pCO ^c MEDIUM	
	Master (address 1)	Slave (address 2)	Master (address 1)	Slave (address 2)	Master (address 1)	Slave (address 2)
NO1	Compressor 1	Compressor 5	Compressor 1	Compressor 5	Evap. pump 1	
NO2	Compressor 2	Compressor 6	Compressor 2	Compressor 6	Compressor 1	Compressor 5
NO3	Liq. solenoid circuit 1	Liq. solenoid circuit 3	Liq. solenoid circuit 1	Liq. solenoid circuit 3	Compressor 2	Compressor 6
NO4	Compressor 3	Compressor 7	Compressor 3	Compressor 7	Liq. solenoid circuit 1	Liq. solenoid circuit 3
NO5	Compressor 4	Compressor 8	Compressor 4	Compressor 8	Valve A	
NO6	Liq. solenoid circuit 2	Liq. solenoid circuit 4	Liq. solenoid circuit 2	Liq. solenoid circuit 4	Compressor 3	Compressor 7
NO7	Evap. pump 1	Evap. pump 2. / Disable fan coil	Evap. pump 1	Evap. pump 2. / Disable fan coil	Compressor 4	Compressor 8
NO8	General alarm	General alarm	General alarm	General alarm	Liq. solenoid circuit 2	Liq. solenoid circuit 4
NO9	Condenser fans	Condenser fans	Condenser fans	Condenser fans	Valve B	
NO10	Valve C		Valve C		Antifreeze heater 1	Antifreeze heater 2
NO11	Antifreeze heater 1	Antifreeze heater 2	Antifreeze heater 1	Antifreeze heater 2	General alarm	General alarm
NO12	Valve A		Valve A		Condenser fans	Condenser fans
NO13	Valve B		Valve B		Valve C	

ANALOGUE OUTPUTS

No.	pCO ² /pCO ³ MEDIUM		pCO ¹ MEDIUM		pCO ^c MEDIUM	
	Master (address 1)	Slave (address 2)	Master (address 1)	Slave (address 2)	Master (address 1)	Slave (address 2)
Y1					Cond. fan inverter	Cond. fan inverter
Y2						
Y3	Cond. fan 1 inverter	Cond. fan 3 inverter	Cond. fan 1 inverter	Cond. fan 3 inverter		
Y4	Cond. fan 2 inverter	Cond. fan 4 inverter	Cond. fan 2 inverter	Cond. fan 4 inverter		

6.5 Cooling-only condensing units, configuration "4"

AIR/AIR units with maximum 8 tandem hermetic compressors.

DIGITAL INPUTS

No.	pCO ² / pCO ³ MEDIUM		pCO ¹ MEDIUM		pCO ^c MEDIUM	
	Master (address 1)	Slave (address 2)	Master (address 1)	Slave (address 2)	Master (address 1)	Slave (address 2)
ID 1	Serious alarm	Serious alarm (can be enabled)	Serious alarm	Serious alarm (can be enabled)	Serious alarm	Serious alarm (can be enabled)
ID 2	Evaporator flow switch	Evap. flow switch (can be enabled)	Evaporator flow switch	Evap. flow switch (can be enabled)	Evaporator flow switch	Evap. flow switch (can be enabled)
ID 3	Remote ON/OFF		Remote ON/OFF		Remote ON/OFF	
ID 4	Fan thermal overload		Fan thermal overload		Fan thermal overload	
ID 5	Low press. switch 1	Low press. switch 3	Low press. switch 1	Low press. switch 3	Low press. switch 1	Low press. switch 3
ID 6	Comp. 1 thermal overload	Comp. 5 thermal overload	Comp. 1 thermal overload	Comp. 5 thermal overload	Comp. 1 thermal overload	Comp. 5 thermal overload
ID 7	Comp. 2 thermal overload	Comp. 6 thermal overload	Comp. 2 thermal overload	Comp. 6 thermal overload	Comp. 2 thermal overload	Comp. 6 thermal overload
ID 8	Low press. switch 2	Low press. switch 4	Low press. switch 2	Low press. switch 4	Low press. switch 2	Low press. switch 4
ID 9	Comp. 3 thermal overload	Comp. 7 thermal overload	Comp. 3 thermal overload	Comp. 7 thermal overload	Comp. 3 thermal overload	Comp. 7 thermal overload
ID 10	Comp. 4 thermal overload	Comp. 8 thermal overload	Comp. 4 thermal overload	Comp. 8 thermal overload	Comp. 4 thermal overload	Comp. 8 thermal overload
ID 11					High press. switch 1	High press. switch 3
ID 12					High press. switch 2	High press. switch 4
ID 13	High press. switch 1	High press. switch 3	High press. switch 1	High press. switch 3		
ID 14	High press. switch 2	High press. switch 4	High press. switch 2	High press. switch 4		

ANALOGUE INPUTS

No.	pCO ² / pCO ³ MEDIUM		pCO ¹ MEDIUM		pCO ^c MEDIUM	
	Master (address 1)	Slave (address 2)	Master (address 1)	Slave (address 2)	Master (address 1)	Slave (address 2)
B1	Cond. temp. circuit 1	Cond. temp. circuit 3	Remote comp. control			
B2	Cond. temp. circuit 2	Cond. temp. circuit 4			Air outlet temp. 1	Air outlet temp. 2
B3	Remote comp. control		High pressure circuit 1	High pressure circuit 3	Cond. temp. circuit 1	Cond. temp. circuit 3
B4			High pressure circuit 2	High pressure circuit 4	Cond. temp. circuit 2	Cond. temp. circuit 4
B5	Air outlet temp. 1	Air outlet temp. 2			Remote comp. control	
B6			Air outlet temp. 1	Air outlet temp. 2		
B7	High pressure circuit 1	High pressure circuit 3	Cond. temp. circuit 1	Cond. temp. circuit 3	High pressure circuit 1	High pressure circuit 3
B8	High pressure circuit 2	High pressure circuit 4	Cond. temp. circuit 2	Cond. temp. circuit 4	High pressure circuit 2	High pressure circuit 4

DIGITAL OUTPUTS

No.	pCO ² / pCO ³ MEDIUM		pCO ¹ MEDIUM		pCO ^c MEDIUM	
	Master (address 1)	Slave (address 2)	Master (address 1)	Slave (address 2)	Master (address 1)	Slave (address 2)
NO1	Compressor 1	Compressor 5	Compressor 1	Compressor 5	Circulating fan	
NO2	Compressor 2	Compressor 6	Compressor 2	Compressor 6	Compressor 1	Compressor 5
NO3	Liq. solenoid circuit 1	Liq. solenoid circuit 3	Liq. solenoid circuit 1	Liq. solenoid circuit 3	Compressor 2	Compressor 6
NO4	Compressor 3	Compressor 7	Compressor 3	Compressor 7	Liq. solenoid circuit 1	Liq. solenoid circuit 3
NO5	Compressor 4	Compressor 8	Compressor 4	Compressor 8		
NO6	Liq. solenoid circuit 2	Liq. solenoid circuit 4	Liq. solenoid circuit 2	Liq. solenoid circuit 4	Compressor 3	Compressor 7
NO7	Circulating fan		Circulating fan		Compressor 4	Compressor 8
NO8	General alarm	General alarm	General alarm	General alarm	Liq. solenoid circuit 2	Liq. solenoid circuit 4
NO9	Cond. fan 1 circuit 1	Cond. fan 1 circuit 3	Cond. fan 1 circuit 1	Cond. fan 1 circuit 3		
NO10	Cond. fan 1 circuit 2 or Cond. fan 2 circuit 1	Cond. fan 1 circuit 4 or Cond. fan 2 circuit 3	Cond. fan 1 circuit 2 or Cond. fan 2 circuit 1	Cond. fan 1 circuit 4 or Cond. fan 2 circuit 3	Antifreeze heater 1	Antifreeze heater 2
NO11	Antifreeze heater 1	Antifreeze heater 2	Antifreeze heater 1	Antifreeze heater 2	General alarm	General alarm
NO12					Cond. fan 1 circuit 1	Cond. fan 1 circuit 3
NO13					Cond. fan 1 circuit 2 or Cond. fan 2 circuit 1	Cond. fan 1 circuit 4 or Cond. fan 2 circuit 3

ANALOGUE OUTPUTS

No.	pCO ² / pCO ³ MEDIUM		pCO ¹ MEDIUM		pCO ^c MEDIUM	
	Master (address 1)	Slave (address 2)	Master (address 1)	Slave (address 2)	Master (address 1)	Slave (address 2)
Y1					Cond. fan 1 inverter	Cond. fan 3 inverter
Y2					Cond. fan 2 inverter	Cond. fan 4 inverter
Y3	Cond. fan 1 inverter	Cond. fan 3 inverter	Cond. fan 1 inverter	Cond. fan 3 inverter		
Y4	Cond. fan 2 inverter	Cond. fan 4 inverter	Cond. fan 2 inverter	Cond. fan 4 inverter		

6.6 Condensing units with heat pump, configuration "5"

AIR/AIR units with maximum 8 tandem hermetic compressors.

DIGITAL INPUTS

No.	pCO ² /pCO ³ MEDIUM		pCO ¹ MEDIUM		pCO ^c MEDIUM	
	Master (address 1)	Slave (address 2)	Master (address 1)	Slave (address 2)	Master (address 1)	Slave (address 2)
ID 1	Serious alarm	Serious alarm (can be enabled)	Serious alarm	Serious alarm (can be enabled)	Serious alarm	Serious alarm (can be enabled)
ID 2	Evaporator flow switch	Evap. flow switch (can be enabled)	Evaporator flow switch	Evap. flow switch (can be enabled)	Evaporator flow switch	Evap. flow switch (can be enabled)
ID 3	Remote ON/OFF		Remote ON/OFF		Remote ON/OFF	
ID 4	Fan thermal overload		Fan thermal overload		Cooling/heating selection	
ID 5	Low press. switch 1	Low press. switch 3	Low press. switch 1	Low press. switch 3	Low press. switch 1	Low press. switch 3
ID 6	Comp. 1 thermal overload	Comp. 5 thermal overload	Comp. 1 thermal overload	Comp. 5 thermal overload	Comp. 1 thermal overload	Comp. 5 thermal overload
ID 7	Comp. 2 thermal overload	Comp. 6 thermal overload	Comp. 2 thermal overload	Comp. 6 thermal overload	Comp. 2 thermal overload	Comp. 6 thermal overload
ID 8	Low press. switch 2	Low press. switch 4	Low press. switch 2	Low press. switch 4	Low press. switch 2	Low press. switch 4
ID 9	Comp. 3 thermal overload	Comp. 7 thermal overload	Comp. 3 thermal overload	Comp. 7 thermal overload	Comp. 3 thermal overload	Comp. 7 thermal overload
ID10	Comp. 4 thermal overload	Comp. 8 thermal overload	Comp. 4 thermal overload	Comp. 8 thermal overload	Comp. 4 thermal overload	Comp. 8 thermal overload
ID11	Cooling/heating selection		Cooling/heating selection		High press. switch 1	High press. switch 3
ID12					High press. switch 2	High press. switch 4
ID13	High press. switch 1	High press. switch 3	High press. switch 1	High press. switch 3		
ID14	High press. switch 2	High press. switch 4	High press. switch 2	High press. switch 4		

ANALOGUE INPUTS

No.	pCO ² /pCO ³ MEDIUM		pCO ¹ MEDIUM		pCO ^c MEDIUM	
	Master (address 1)	Slave (address 2)	Master (address 1)	Slave (address 2)	Master (address 1)	Slave (address 2)
B1	Cond. temp. circuit 1	Cond. temp. circuit 3	Remote comp. control			
B2	Cond. temp. circuit 2	Cond. temp. circuit 4			Air outlet temp. 1	Air outlet temp. 2
B3	Remote comp. control		High pressure circuit 1	High pressure circuit 3	Cond. temp. circuit 1	Cond. temp. circuit 3
B4			High pressure circuit 2	High pressure circuit 4	Cond. temp. circuit 2	Cond. temp. circuit 4
B5	Air outlet temp. 1	Air outlet temp. 2			Remote comp. control	
B6			Air outlet temp. 1	Air outlet temp. 2		
B7	High pressure circuit 1	High pressure circuit 3	Cond. temp. circuit 1	Cond. temp. circuit 3	High pressure circuit 1	High pressure circuit 3
B8	High pressure circuit 2	High pressure circuit 4	Cond. temp. circuit 2	Cond. temp. circuit 4	High pressure circuit 2	High pressure circuit 4

DIGITAL OUTPUTS

No.	pCO ² /pCO ³ MEDIUM		pCO ¹ MEDIUM		pCO ^c MEDIUM	
	Master (address 1)	Slave (address 2)	Master (address 1)	Slave (address 2)	Master (address 1)	Slave (address 2)
NO1	Compressor 1	Compressor 5	Compressor 1	Compressor 5	Circulating fan	
NO2	Compressor 2	Compressor 6	Compressor 2	Compressor 6	Compressor 1	Compressor 5
NO3	Liq. solenoid circuit 1	Liq. solenoid circuit 3	Liq. solenoid circuit 1	Liq. solenoid circuit 3	Compressor 2	Compressor 6
NO 4	Compressor 3	Compressor 7	Compressor 3	Compressor 7	Liq. solenoid circuit 1	Liq. solenoid circuit 3
NO 5	Compressor 4	Compressor 8	Compressor 4	Compressor 8	4-way valve circuit 1	4-way valve circuit 3
NO 6	Liq. solenoid circuit 2	Liq. solenoid circuit 4	Liq. solenoid circuit 2	Liq. solenoid circuit 4	Compressor 3	Compressor 7
NO 7	Circulating fan		Circulating fan		Compressor 4	Compressor 8
NO 8	General alarm	General alarm	General alarm	General alarm	Liq. solenoid circuit 2	Liq. solenoid circuit 4
NO 9	Cond. fan 1 circuit 1	Cond. fan 1 circuit 3	Cond. fan 1 circuit 1	Cond. fan 1 circuit 3	4-way valve circuit 2	4-way valve circuit 4
NO10	Cond. fan 1 circuit 2 or Cond. fan 2 circuit 1	Cond. fan 1 circuit 4 or Cond. fan 2 circuit 3	Cond. fan 1 circuit 2 or Cond. fan 2 circuit 1	Cond. fan 1 circuit 4 or Cond. fan 2 circuit 3	Antifreeze heater 1	Antifreeze heater 2
NO11	Antifreeze heater 1	Antifreeze heater 2	Antifreeze heater 1	Antifreeze heater 2	General alarm	General alarm
NO12	4-way valve circuit 1	4-way valve circuit 3	4-way valve circuit 1	4-way valve circuit 3	Cond. fan 1 circuit 1	Cond. fan 1 circuit 3
NO13	4-way valve circuit 2	4-way valve circuit 4	4-way valve circuit 2	4-way valve circuit 4	Cond. fan 1 circuit 2 or Cond. fan 2 circuit 1	Cond. fan 1 circuit 4 or Cond. fan 2 circuit 3

ANALOGUE OUTPUTS

No.	pCO ² /pCO ³ MEDIUM		pCO ¹ MEDIUM		pCO ^c MEDIUM	
	Master (address 1)	Slave (address 2)	Master (address 1)	Slave (address 2)	Master (address 1)	Slave (address 2)
Y1					Cond. fan 1 inverter	Cond. fan 3 inverter
Y2					Cond. fan 2 inverter	Cond. fan 4 inverter
Y3	Cond. fan 1 inverter	Cond. fan 3 inverter	Cond. fan 1 inverter	Cond. fan 3 inverter		
Y4	Cond. fan 2 inverter	Cond. fan 4 inverter	Cond. fan 2 inverter	Cond. fan 4 inverter		

6.7 Chiller-only units, configuration "6"

WATER/WATER units with maximum 8 tandem hermetic compressors.

DIGITAL INPUTS

No.	pCO ² /pCO ³ MEDIUM		pCO ¹ MEDIUM		pCO ^c MEDIUM	
	Master (address 1)	Slave (address 2)	Master (address 1)	Slave (address 2)	Master (address 1)	Slave (address 2)
ID 1	Serious alarm	Serious alarm (can be enabled)	Serious alarm	Serious alarm (can be enabled)	Serious alarm	Serious alarm (can be enabled)
ID 2	Evaporator flow switch	Evap. flow switch (can be enabled)	Evaporator flow switch	Evap. flow switch (can be enabled)	Evaporator flow switch	Evap. flow switch (can be enabled)
ID 3	Remote ON/OFF		Remote ON/OFF		Remote ON/OFF	
ID 4	Pump 1 thermal overload	Pump 2 thermal overload	Pump 1 thermal overload	Pump 2 thermal overload	Pump thermal overload	
ID 5	Low press. switch 1	Low press. switch 3	Low press. switch 1	Low press. switch 3	Low press. switch 1	Low press. switch 3
ID 6	Comp. 1 thermal overload	Comp. 5 thermal overload	Comp. 1 thermal overload	Comp. 5 thermal overload	Comp. 1 thermal overload	Comp. 5 thermal overload
ID 7	Comp. 2 thermal overload	Comp. 6 thermal overload	Comp. 2 thermal overload	Comp. 6 thermal overload	Comp. 2 thermal overload	Comp. 6 thermal overload
ID 8	Low press. switch 2	Low press. switch 4	Low press. switch 2	Low press. switch 4	Low press. switch 2	Low press. switch 4
ID 9	Comp. 3 thermal overload	Comp. 7 thermal overload	Comp. 3 thermal overload	Comp. 7 thermal overload	Comp. 3 thermal overload	Comp. 7 thermal overload
ID10	Comp. 4 thermal overload	Comp. 8 thermal overload	Comp. 4 thermal overload	Comp. 8 thermal overload	Comp. 4 thermal overload	Comp. 8 thermal overload
ID11					High press. switch 1	High press. switch 3
ID12					High press. switch 2	High press. switch 4
ID13	High press. switch 1	High press. switch 3	High press. switch 1	High press. switch 3		
ID14	High press. switch 2	High press. switch 4	High press. switch 2	High press. switch 4		

ANALOGUE INPUTS

No.	pCO ² /pCO ³ MEDIUM		pCO ¹ MEDIUM		pCO ^c MEDIUM	
	Master (address 1)	Slave (address 2)	Master (address 1)	Slave (address 2)	Master (address 1)	Slave (address 2)
B1	Cond. inlet temp. 1	Cond. inlet temp. 2	Outside set point		Water inlet temp.	
B2	Cond. outlet temp. 1	Cond. outlet temp. 2			Water outlet temp. 1	Water outlet temp. 2
B3	Outside set point		High pressure circuit 1	High pressure circuit 3	Cond. inlet temp. 1	Cond. inlet temp. 2
B4	Water inlet temp.		High pressure circuit 2	High pressure circuit 4	Cond. outlet temp. 1	Cond. outlet temp. 2
B5	Water outlet temp. 1	Water outlet temp. 2	Water inlet temp.		Outside set point	
B6			Water outlet temp. 1	Water outlet temp. 2		
B7	High pressure circuit 1	High pressure circuit 3	Cond. inlet temp. 1	Cond. inlet temp. 2	High pressure circuit 1	High pressure circuit 3
B8	High pressure circuit 2	High pressure circuit 4	Cond. outlet temp. 1	Cond. outlet temp. 2	High pressure circuit 2	High pressure circuit 4

DIGITAL OUTPUTS

No.	pCO ² /pCO ³ MEDIUM		pCO ¹ MEDIUM		pCO ^c MEDIUM	
	Master (address 1)	Slave (address 2)	Master (address 1)	Slave (address 2)	Master (address 1)	Slave (address 2)
NO1	Compressor 1	Compressor 5	Compressor 1	Compressor 5	Evap. pump 1	
NO2	Compressor 2	Compressor 6	Compressor 2	Compressor 6	Compressor 1	Compressor 5
NO3	Liquid solenoid circ. 1	Liquid solenoid circ. 3	Liquid solenoid circ. 1	Liquid solenoid circ. 3	Compressor 2	Compressor 6
NO 4	Compressor 3	Compressor 7	Compressor 3	Compressor 7	Liquid solenoid circ. 1	Liquid solenoid circ. 3
NO 5	Compressor 4	Compressor 8	Compressor 4	Compressor 8		
NO 6	Liquid solenoid circ.2	Liquid solenoid circ.4	Liquid solenoid circ.2	Liquid solenoid circ.4	Compressor 3	Compressor 7
NO 7	Evap. pump 1	Evap. pump 2. / Disable fan coil	Evap. pump 1	Evap. pump 2. / Disable fan coil	Compressor 4	Compressor 8
NO 8	General alarm	General alarm	General alarm	General alarm	Liquid solenoid circ.2	Liquid solenoid circ.4
NO 9					Cond. pump 1	
NO10					Antifreeze heater 1	Antifreeze heater 2
NO11	Antifreeze heater 1	Antifreeze heater 2	Antifreeze heater 1	Antifreeze heater 2	General alarm	General alarm
NO12						
NO13	Cond. pump 1		Cond. pump 1			

ANALOGUE OUTPUTS

No.	pCO ² /pCO ³ MEDIUM		pCO ¹ MEDIUM		pCO ^c MEDIUM	
	Master (address 1)	Slave (address 2)	Master (address 1)	Slave (address 2)	Master (address 1)	Slave (address 2)
Y1						
Y2						
Y3						
Y4						

6.8 Chiller / heat pump units with reversal on water circuit, configuration "7"

WATER/WATER units with maximum 8 tandem hermetic compressors.

DIGITAL INPUTS

No.	pCO ² /pCO ³ MEDIUM		pCO ¹ MEDIUM		pCO ^c MEDIUM	
	Master (address 1)	Slave (address 2)	Master (address 1)	Slave (address 2)	Master (address 1)	Slave (address 2)
ID 1	Serious alarm	Serious alarm (can be enabled)	Serious alarm	Serious alarm (can be enabled)	Serious alarm	Serious alarm (can be enabled)
ID 2	Evaporator flow switch	Evap. flow switch (can be enabled)	Evaporator flow switch	Evap. flow switch (can be enabled)	Evaporator flow switch	Evap. flow switch (can be enabled)
ID 3	Remote ON/OFF		Remote ON/OFF		Remote ON/OFF	
ID 4	Pump 1 thermal overload	Pump 2 thermal overload	Pump 1 thermal overload	Pump 2 thermal overload	Cooling/heating selector	
ID 5	Low press. switch 1	Low press. switch 3	Low press. switch 1	Low press. switch 3	Low press. switch 1	Low press. switch 3
ID 6	Comp. 1 thermal overload	Comp. 5 thermal overload	Comp. 1 thermal overload	Comp. 5 thermal overload	Comp. 1 thermal overload	Comp. 5 thermal overload
ID 7	Comp. 2 thermal overload	Comp. 6 thermal overload	Comp. 2 thermal overload	Comp. 6 thermal overload	Comp. 2 thermal overload	Comp. 6 thermal overload
ID 8	Low press. switch 2	Low press. switch 4	Low press. switch 2	Low press. switch 4	Low press. switch 2	Low press. switch 4
ID 9	Comp. 3 thermal overload	Comp. 7 thermal overload	Comp. 3 thermal overload	Comp. 7 thermal overload	Comp. 3 thermal overload	Comp. 7 thermal overload
ID 10	Comp. 4 thermal overload	Comp. 8 thermal overload	Comp. 4 thermal overload	Comp. 8 thermal overload	Comp. 4 thermal overload	Comp. 8 thermal overload
ID 11	Cooling/heating selector		Cooling/heating selector		High press. switch 1	High press. switch 3
ID 12					High press. switch 2	High press. switch 4
ID 13	High press. switch 1	High press. switch 3	High press. switch 1	High press. switch 3		
ID 14	High press. switch 2	High press. switch 4	High press. switch 2	High press. switch 4		

ANALOGUE INPUTS

No.	pCO ² /pCO ³ MEDIUM		pCO ¹ MEDIUM		pCO ^c MEDIUM	
	Master (address 1)	Slave (address 2)	Master (address 1)	Slave (address 2)	Master (address 1)	Slave (address 2)
B1	Cond. inlet temp. 1	Cond. inlet temp. 2	Outside set point		Water inlet temp.	
B2	Cond. outlet temp. 1	Cond. outlet temp. 2			Water outlet temp. 1	Water outlet temp. 2
B3	Outside set point		High pressure circuit 1	High pressure circuit 3	Cond. inlet temp. 1	Cond. inlet temp. 2
B4	Water inlet temp.		High pressure circuit 2	High pressure circuit 4	Cond. outlet temp. 1	Cond. outlet temp. 2
B5	Water outlet temp. 1	Water outlet temp. 2	Water inlet temp.		Outside set point	
B6			Water outlet temp. 1	Water outlet temp. 2		
B7	High pressure circuit 1	High pressure circuit 3	Cond. inlet temp. 1	Cond. inlet temp. 2	High pressure circuit 1	High pressure circuit 3
B8	High pressure circuit 2	High pressure circuit 4	Cond. outlet temp. 1	Cond. outlet temp. 2	High pressure circuit 2	High pressure circuit 4

DIGITAL OUTPUTS

No.	pCO ² /pCO ³ MEDIUM		pCO ¹ MEDIUM		pCO ^c MEDIUM	
	Master (address 1)	Slave (address 2)	Master (address 1)	Slave (address 2)	Master (address 1)	Slave (address 2)
NO1	Compressor 1	Compressor 5	Compressor 1	Compressor 5	Evap. pump 1	
NO2	Compressor 2	Compressor 6	Compressor 2	Compressor 6	Compressor 1	Compressor 5
NO3	Liq. solenoid circuit 1	Liq. solenoid circuit 3	Liq. solenoid circuit 1	Liq. solenoid circuit 3	Compressor 2	Compressor 6
NO 4	Compressor 3	Compressor 7	Compressor 3	Compressor 7	Liq. solenoid circuit 1	Liq. solenoid circuit 3
NO 5	Compressor 4	Compressor 8	Compressor 4	Compressor 8	Water circ. reversing valve	
NO 6	Liq. solenoid circuit 2	Liq. solenoid circuit 4	Liq. solenoid circuit 2	Liq. solenoid circuit 4	Compressor 3	Compressor 7
NO 7	Evap. pump 1	Evap. pump 2. / Disable fan coil	Evap. pump 1	Evap. pump 2. / Disable fan coil	Compressor 4	Compressor 8
NO 8	General alarm	General alarm	General alarm	General alarm	Liq. solenoid circuit 2	Liq. solenoid circuit 4
NO 9					Cond. pump 1	
NO10					Antifreeze heater 1	Antifreeze heater 2
NO11	Antifreeze heater 1	Antifreeze heater 2	Antifreeze heater 1	Antifreeze heater 2	General alarm	General alarm
NO12	Water circ. reversing valve		Water circ. reversing valve			
NO13	Cond. pump 1		Cond. pump 1			

ANALOGUE OUTPUTS

No.	pCO ² /pCO ³ MEDIUM		pCO ¹ MEDIUM		pCO ^c MEDIUM	
	Master (address 1)	Slave (address 2)	Master (address 1)	Slave (address 2)	Master (address 1)	Slave (address 2)
Y1						
Y2						
Y3						
Y4						

6.9 Chiller-only units, configuration "8"

AIR/WATER units with maximum 8 semi-hermetic compressors (1 load step per compressor).

DIGITAL INPUTS

No.	pCO ² /pCO ³ MEDIUM		pCO ¹ MEDIUM		pCO ^c MEDIUM	
	Master (address 1)	Slaves (addresses 2/3/4)	Master (address 1)	Slaves (addresses 2/3/4)	Master (address 1)	Slaves (addresses 2/3/4)
ID 1	Serious alarm	Serious alarm (can be enabled)	Serious alarm	Serious alarm (can be enabled)	Serious alarm	Serious alarm (can be enabled)
ID 2	Evaporator flow switch	Evap. flow switch (can be enabled)	Evaporator flow switch	Evap. flow switch (can be enabled)	Evaporator flow switch	Evap. flow switch (can be enabled)
ID 3	Remote ON/OFF		Remote ON/OFF		Remote ON/OFF	
ID 4	Pump 1 thermal overload	Pump 2 thermal overload	Pump thermal overload	Pump 2 thermal overload	Pump thermal overload	
ID 5	Low press. switch 1	Low press. switch 3	Low press. switch 1	Low press. switch 3	Low press. switch 1	Low press. switch 3
ID 6	Oil differential 1	Oil differential 3	Oil differential 1	Oil differential 3	Oil differential 1	Oil differential 3
ID 7	Fan 1 thermal overload	Fan 3 thermal overload	Fan 1 thermal overload	Fan 3 thermal overload	Fan 1 thermal overload	Fan 3 thermal overload
ID 8	Low press. switch 2	Low press. switch 4	Low press. switch 2	Low press. switch 4	Low press. switch 2	Low press. switch 4
ID 9	Oil differential 2	Oil differential 4	Oil differential 2	Oil differential 4	Oil differential 2	Oil differential 4
ID10	Fan 2 thermal overload	Fan thermal overload 4	Fan 2 thermal overload	Fan thermal overload 4	Fan 2 thermal overload	Fan thermal overload 4
ID11	Comp. 1 thermal overload	Comp. 3 thermal overload	Comp. 1 thermal overload	Comp. 3 thermal overload	High press. switch 1 / Comp. 1 thermal overload	High press. switch 3 / Comp. 3 thermal overload
ID12	Comp. 2 thermal overload	Comp. 4 thermal overload	Comp. 2 thermal overload	Comp. 4 thermal overload	High press. switch 2 / Comp. 2 thermal overload	High press. switch 4 / Comp. 4 thermal overload
ID13	High press. switch 1	High press. switch 3	High press. switch 1	High press. switch 3		
ID14	High press. switch 2	High press. switch 4	High press. switch 2	High press. switch 4		

ANALOGUE INPUTS

No.	pCO ² /pCO ³ MEDIUM		pCO ¹ MEDIUM		pCO ^c MEDIUM	
	Master (address 1)	Slaves (addresses 2/3/4)	Master (address 1)	Slaves (addresses 2/3/4)	Master (address 1)	Slaves (addresses 2/3/4)
B1	Cond. temp. circuit 1	Cond. temp. circuit 3	Outside set point		Water inlet temp.	
B2	Cond. temp. circuit 2	Cond. temp. circuit 4			Water outlet temp. 1	Water outlet temp. 2
B3	Outside set point		High pressure circuit 1	High pressure circuit 3	Cond. temp. circuit 1	Cond. temp. circuit 3
B4	Water inlet temp.		High pressure circuit 2	High pressure circuit 4	Cond. temp. circuit 2	Cond. temp. circuit 4
B5	Water outlet temp. 1	Water outlet temp. 2	Water inlet temp.		Outside set point	
B6			Water outlet temp. 1	Water outlet temp. 2		
B7	High pressure circuit 1	High pressure circuit 3	Cond. temp. circuit 1	Cond. temp. circuit 3	High pressure circuit 1	High pressure circuit 3
B8	High pressure circuit 2	High pressure circuit 4	Cond. temp. circuit 2	Cond. temp. circuit 4	High pressure circuit 2	High pressure circuit 4

DIGITAL OUTPUTS

No.	pCO ² /pCO ³ MEDIUM		pCO ¹ MEDIUM		pCO ^c MEDIUM	
	Master (address 1)	Slaves (addresses 2/3/4)	Master (address 1)	Slaves (addresses 2/3/4)	Master (address 1)	Slaves (addresses 2/3/4)
NO1	Winding A comp. 1	Winding A comp. 3	Winding A comp. 1	Winding A comp. 3	Evap. pump 1	
NO2	Winding B comp. 1	Winding B comp. 3	Winding B comp. 1	Winding B comp. 3	Winding A comp. 1	Winding A comp. 3
NO3	Part load comp. 1	Part load comp. 3	Part load comp. 1	Part load comp. 3	Winding B comp. 1	Winding B comp. 3
NO 4	Winding A comp. 2	Winding A comp. 4	Winding A comp. 2	Winding A comp. 4	Liq. solenoid circuit 1	Liq. solenoid circuit 3
NO 5	Winding B comp. 2	Winding B comp. 4	Winding B comp. 2	Winding B comp. 4	Part load comp. 1	Part load comp. 3
NO 6	Part load comp. 2	Part load comp. 4	Part load comp. 2	Part load comp. 4	Winding A comp. 2	Winding A comp. 4
NO 7	Evap. pump 1	Evap. pump 2. / Disable fan coil	Evap. pump 1	Evap. pump 2. / Disable fan coil	Winding B comp. 2	Winding B comp. 4
NO 8	General alarm	General alarm	General alarm	General alarm	Liq. solenoid circuit 2	Liq. solenoid circuit 4
NO 9	Cond. fan 1 circuit 1	Cond. fan 1 circuit 3	Cond. fan 1 circuit 1	Cond. fan 1 circuit 3	Part load comp. 2	Part load comp. 4
NO10	Cond. fan 1 circuit 2 or Cond. fan 2 circuit 1	Cond. fan 1 circuit 4 or Cond. fan 2 circuit 3	Cond. fan 1 circuit 2 or Cond. fan 2 circuit 1	Cond. fan 1 circuit 4 or Cond. fan 2 circuit 3	Antifreeze heater 1	Antifreeze heater 2
NO11	Antifreeze heater 1	Antifreeze heater 2	Antifreeze heater 1	Antifreeze heater 2	General alarm	General alarm
NO12	Liq. solenoid circuit 1	Liq. solenoid circuit 3	Liq. solenoid circuit 1	Liq. solenoid circuit 3	Cond. fan 1 circuit 1	Cond. fan 1 circuit 3
NO13	Liq. solenoid circuit 2	Liq. solenoid circuit 4	Liq. solenoid circuit 2	Liq. solenoid circuit 4	Cond. fan 1 circuit 2 or Cond. fan 2 circuit 1	Cond. fan 1 circuit 4 or Cond. fan 2 circuit 3

ANALOGUE OUTPUTS

No.	pCO ² MEDIUM		pCO ¹ MEDIUM		pCO ^c MEDIUM	
	Master (address 1)	Slaves (addresses 2/3/4)	Master (address 1)	Slaves (addresses 2/3/4)	Master (address 1)	Slaves (addresses 2/3/4)
Y1					Cond. fan 1 inverter	Cond. fan 3 inverter
Y2					Cond. fan 2 inverter	Cond. fan 4 inverter
Y3	Cond. fan 1 inverter	Cond. fan 3 inverter	Cond. fan 1 inverter	Cond. fan 3 inverter		
Y4	Cond. fan 2 inverter	Cond. fan 4 inverter	Cond. fan 2 inverter	Cond. fan 4 inverter		

6.10 Chiller units with freecooling, configuration "9"

AIR/WATER units with maximum 8 semi-hermetic compressors (1 load step per compressor).

DIGITAL INPUTS

No.	pCO ² /pCO ³ MEDIUM		pCO ¹ MEDIUM		pCO ^c MEDIUM	
	Master (address 1)	Slaves (addresses 2/3/4)	Master (address 1)	Slaves (addresses 2/3/4)	Master (address 1)	Slaves (addresses 2/3/4)
ID 1	Serious alarm	Serious alarm (can be enabled)	Serious alarm	Serious alarm (can be enabled)	Serious alarm	Serious alarm (can be enabled)
ID 2	Evaporator flow switch	Evap. flow switch (can be enabled)	Evaporator flow switch	Evap. flow switch (can be enabled)	Evaporator flow switch	Evap. flow switch (can be enabled)
ID 3	Remote ON/OFF		Remote ON/OFF		Remote ON/OFF	
ID 4	Pump 1 thermal overload	Pump 2 thermal overload	Pump thermal overload	Pump 2 thermal overload	Pump thermal overload	
ID 5	Low press. switch 1	Low press. switch 3	Low press. switch 1	Low press. switch 3	Low press. switch 1	Low press. switch 3
ID 6	Oil differential 1	Oil differential 3	Oil differential 1	Oil differential 3	Oil differential 1	Oil differential 3
ID 7	Fan 1 thermal overload	Fan 3 thermal overload	Fan 1 thermal overload	Fan 3 thermal overload	Fan 1 thermal overload	Fan 3 thermal overload
ID 8	Low press. switch 2	Low press. switch 4	Low press. switch 2	Low press. switch 4	Low press. switch 2	Low press. switch 4
ID 9	Oil differential 2	Oil differential 4	Oil differential 2	Oil differential 4	Oil differential 2	Oil differential 4
ID10	Fan 2 thermal overload	Fan thermal overload 4	Fan 2 thermal overload	Fan thermal overload 4	Fan 2 thermal overload	Fan thermal overload 4
ID11	Comp. 1 thermal overload	Comp. 3 thermal overload	Comp. 1 thermal overload	Comp. 3 thermal overload	High press. switch 1 / Comp. 1 thermal overload	High press. switch 3 / Comp. 3 thermal overload
ID12	Comp. 2 thermal overload	Comp. 4 thermal overload	Comp. 2 thermal overload	Comp. 4 thermal overload	High press. switch 2 / Comp. 2 thermal overload	High press. switch 4 / Comp. 4 thermal overload
ID13	High press. switch 1	High press. switch 3	High press. switch 1	High press. switch 3		
ID14	High press. switch 2	High press. switch 4	High press. switch 2	High press. switch 4		

ANALOGUE INPUTS

No.	pCO ² /pCO ³ MEDIUM		pCO ¹ MEDIUM		pCO ^c MEDIUM	
	Master (address 1)	Slaves (addresses 2/3/4)	Master (address 1)	Slaves (addresses 2/3/4)	Master (address 1)	Slaves (addresses 2/3/4)
B1	Cond. temp. circuit 1	Cond. temp. circuit 3	Outside temperature		Water inlet temp.	
B2	Cond. temp. circuit 2	Cond. temp. circuit 4	Freecooling temperature		Water outlet temp. 1	Water outlet temp. 2
B3	Outside temperature		High pressure circuit 1	High pressure circuit 3	Cond. temp. circuit 1	Cond. temp. circuit 3
B4	Water inlet temp.		High pressure circuit 2	High pressure circuit 4	Cond. temp. circuit 2	Cond. temp. circuit 4
B5	Water outlet temp. 1	Water outlet temp. 2	Water inlet temp.		Outside temperature	
B6	Freecooling temperature		Water outlet temp. 1	Water outlet temp. 2	Freecooling temperature	
B7	High pressure circuit 1	High pressure circuit 3	Cond. temp. circuit 1	Cond. temp. circuit 3	High pressure circuit 1	High pressure circuit 3
B8	High pressure circuit 2	High pressure circuit 4	Cond. temp. circuit 2	Cond. temp. circuit 4	High pressure circuit 2	High pressure circuit 4

DIGITAL OUTPUTS

No.	pCO ² /pCO ³ MEDIUM		pCO ¹ MEDIUM		pCO ^c MEDIUM	
	Master (address 1)	Slaves (addresses 2/3/4)	Master (address 1)	Slaves (addresses 2/3/4)	Master (address 1)	Slaves (addresses 2/3/4)
NO1	Winding A comp. 1	Winding A comp. 3	Winding A comp. 1	Winding A comp. 3	Evap. pump 1	
NO2	Winding B comp. 1	Winding B comp. 3	Winding B comp. 1	Winding B comp. 3	Winding A comp. 1	Winding A comp. 3
NO3	Part load comp. 1	Part load comp. 3	Part load comp. 1	Part load comp. 3	Winding B comp. 1	Winding B comp. 3
NO 4	Winding A comp. 2	Winding A comp. 4	Winding A comp. 2	Winding A comp. 4	Liq. solenoid circuit 1	Liq. solenoid circuit 3
NO 5	Winding B comp. 2	Winding B comp. 4	Winding B comp. 2	Winding B comp. 4	Part load comp. 1	Part load comp. 3
NO 6	Part load comp. 2	Part load comp. 4	Part load comp. 2	Part load comp. 4	Winding A comp. 2	Winding A comp. 4
NO 7	Evap. pump 1	Evap. pump 2. / Disable fan coil	Evap. pump 1	Evap. pump 2. / Disable fan coil	Winding B comp. 2	Winding B comp. 4
NO 8	General alarm	General alarm	General alarm	General alarm	Liq. solenoid circuit 2	Liq. solenoid circuit 4
NO 9	Cond. fan 1 circuit 1	Cond. fan 1 circuit 3	Cond. fan 1 circuit 1	Cond. fan 1 circuit 3	Part load comp. 2	Part load comp. 4
NO10	ON/OFF freecooling valve	Cond. fan 1 circuit 4 or Cond. fan 2 circuit 3	ON/OFF freecooling valve	Cond. fan 1 circuit 4 or Cond. fan 2 circuit 3	Cond. fan 1 circuit 2 or Cond. fan 2 circuit 1	Antifreeze heater 2
NO11	Cond. fan 1 circuit 2 or Cond. fan 2 circuit 1	Antifreeze heater 2	Cond. fan 1 circuit 2 or Cond. fan 2 circuit 1	Antifreeze heater 2	General alarm	General alarm
NO12	Liq. solenoid circuit 1	Liq. solenoid circuit 3	Liq. solenoid circuit 1	Liq. solenoid circuit 3	Cond. fan 1 circuit 1	Cond. fan 1 circuit 3
NO13	Liq. solenoid circuit 2	Liq. solenoid circuit 4	Liq. solenoid circuit 2	Liq. solenoid circuit 4	ON/OFF freecooling valve	Cond. fan 1 circuit 4 or Cond. fan 2 circuit 3

ANALOGUE OUTPUTS

No.	pCO ² /pCO ³ MEDIUM		pCO ¹ MEDIUM		pCO ^c MEDIUM	
	Master (address 1)	Slaves (addresses 2/3/4)	Master (address 1)	Slaves (addresses 2/3/4)	Master (address 1)	Slaves (addresses 2/3/4)
Y1	Modul. freecooling valve		Modul. freecooling valve		Cond. fan 1 inverter	Cond. fan 3 inverter
Y2					Modul. freecooling valve	Cond. fan inverter .4
Y3	Cond. fan 1 inverter	Cond. fan 3 inverter	Cond. fan 1 inverter	Cond. fan 3 inverter		
Y4	Cond. fan 2 inverter	Cond. fan inverter .4	Cond. fan 2 inverter	Cond. fan inverter .4		

6.11 Chiller units with heat pump, configuration "10"

AIR/WATER units with maximum 8 semi-hermetic compressors (1 load step per compressor).

DIGITAL INPUTS

No.	pCO ² /pCO ³ MEDIUM		pCO ¹ MEDIUM		pCO ^c MEDIUM	
	Master (address 1)	Slaves (addresses 2/3/4)	Master (address 1)	Slaves (addresses 2/3/4)	Master (address 1)	Slaves (addresses 2/3/4)
ID 1	Serious alarm	Serious alarm (can be enabled)	Serious alarm	Serious alarm (can be enabled)	Serious alarm	Serious alarm (can be enabled)
ID 2	Evaporator flow switch	Evap. flow switch (can be enabled)	Evaporator flow switch	Evap. flow switch (can be enabled)	Evaporator flow switch	Evap. flow switch (can be enabled)
ID 3	Remote ON/OFF		Remote ON/OFF		Remote ON/OFF	
ID 4	Cooling/heating selection		Cooling/heating selection		Cooling/heating selection	
ID 5	Low press. switch 1	Low press. switch 3	Low press. switch 1	Low press. switch 3	Low press. switch 1	Low press. switch 3
ID 6	Oil differential 1	Oil differential 3	Oil differential 1	Oil differential 3	Oil differential 1	Oil differential 3
ID 7	Fan 1 thermal overload	Fan 3 thermal overload	Fan 1 thermal overload	Fan 3 thermal overload	Fan 1 thermal overload	Fan 3 thermal overload
ID 8	Low press. switch 2	Low press. switch 4	Low press. switch 2	Low press. switch 4	Low press. switch 2	Low press. switch 4
ID 9	Oil differential 2	Oil differential 4	Oil differential 2	Oil differential 4	Oil differential 2	Oil differential 4
ID10	Fan 2 thermal overload	Fan thermal overload 4	Fan 2 thermal overload	Fan thermal overload 4	Fan 2 thermal overload	Fan thermal overload 4
ID11	Comp. 1 thermal overload	Comp. 3 thermal overload	Comp. 1 thermal overload	Comp. 3 thermal overload	High press. switch 1 / Comp. 1 thermal overload	High press. switch 3 / Comp. 3 thermal overload
ID12	Comp. 2 thermal overload	Comp. 4 thermal overload	Comp. 2 thermal overload	Comp. 4 thermal overload	High press. switch 2 / Comp. 2 thermal overload	High press. switch 4 / Comp. 4 thermal overload
ID13	High press. switch 1	High press. switch 3	High press. switch 1	High press. switch 3		
ID14	High press. switch 2	High press. switch 4	High press. switch 2	High press. switch 4		

ANALOGUE INPUTS

No.	pCO ² /pCO ³ MEDIUM		pCO ¹ MEDIUM		pCO ^c MEDIUM	
	Master (address 1)	Slaves (addresses 2/3/4)	Master (address 1)	Slaves (addresses 2/3/4)	Master (address 1)	Slaves (addresses 2/3/4)
B1	Cond. temp. circuit 1	Cond. temp. circuit 3	Outside set point		Water inlet temp.	
B2	Cond. temp. circuit 2	Cond. temp. circuit 4			Water outlet temp. 1	Water outlet temp. 2
B3	Outside set point		High pressure circuit 1	High pressure circuit 3	Cond. temp. circuit 1	Cond. temp. circuit 3
B4	Water inlet temp.		High pressure circuit 2	High pressure circuit 4	Cond. temp. circuit 2	Cond. temp. circuit 4
B5	Water outlet temp. 1	Water outlet temp. 2	Water inlet temp.		Outside set point	
B6			Water outlet temp. 1	Water outlet temp. 2		
B7	High pressure circuit 1	High pressure circuit 3	Cond. temp. circuit 1	Cond. temp. circuit 3	High pressure circuit 1	High pressure circuit 3
B8	High pressure circuit 2	High pressure circuit 4	Cond. temp. circuit 2	Cond. temp. circuit 4	High pressure circuit 2	High pressure circuit 4

DIGITAL OUTPUTS

No.	pCO ² /pCO ³ MEDIUM		pCO ¹ MEDIUM		pCO ^c MEDIUM	
	Master (address 1)	Slaves (addresses 2/3/4)	Master (address 1)	Slaves (addresses 2/3/4)	Master (address 1)	Slaves (addresses 2/3/4)
NO1	Winding A comp. 1	Winding A comp. 3	Winding A comp. 1	Winding A comp. 3	Evap. pump 1	
NO2	Winding B comp. 1	Winding B comp. 3	Winding B comp. 1	Winding B comp. 3	Winding A comp. 1	Winding A comp. 3
NO3	Part load comp. 1	Part load comp. 3	Part load comp. 1	Part load comp. 3	Winding B comp. 1	Winding B comp. 3
NO 4	Winding A comp. 2	Winding A comp. 4	Winding A comp. 2	Winding A comp. 4	4-way valve circuit 1	4-way valve circuit 3
NO 5	Winding B comp. 2	Winding B comp. 4	Winding B comp. 2	Winding B comp. 4	Part load comp. 1	Part load comp. 3
NO 6	Part load comp. 2	Part load comp. 4	Part load comp. 2	Part load comp. 4	Winding A comp. 2	Winding A comp. 4
NO 7	Evap. pump 1	Evap. pump 2. / Disable fan coil	Evap. pump 1	Evap. pump 2. / Disable fan coil	Winding B comp. 2	Winding B comp. 4
NO 8	General alarm	General alarm	General alarm	General alarm	4-way valve circuit 2	4-way valve circuit 4
NO 9	Cond. fan 1 circuit 1	Cond. fan 1 circuit 3	Cond. fan 1 circuit 1	Cond. fan 1 circuit 3	Part load comp. 2	Part load comp. 4
NO10	Cond. fan 1 circuit 2 or Cond. fan 2 circuit 1	Cond. fan 1 circuit 4 or Cond. fan 2 circuit 3	Cond. fan 1 circuit 2 or Cond. fan 2 circuit 1	Cond. fan 1 circuit 4 or Cond. fan 2 circuit 3	Antifreeze heater 1	Antifreeze heater 2
NO11	Antifreeze heater 1	Antifreeze heater 2	Antifreeze heater 1	Antifreeze heater 2	General alarm	General alarm
NO12	4-way valve circuit 1	4-way valve circuit 3	4-way valve circuit 1	4-way valve circuit 3	Cond. fan 1 circuit 1	Cond. fan 1 circuit 3
NO13	4-way valve circuit 2	4-way valve circuit 4	4-way valve circuit 2	4-way valve circuit 4	Cond. fan 1 circuit 2 or Cond. fan 2 circuit 1	Cond. fan 1 circuit 4 or Cond. fan 2 circuit 3

ANALOGUE OUTPUTS

No.	pCO ² /pCO ³ MEDIUM		pCO ¹ MEDIUM		pCO ^c MEDIUM	
	Master (address 1)	Slaves (addresses 2/3/4)	Master (address 1)	Slaves (addresses 2/3/4)	Master (address 1)	Slaves (addresses 2/3/4)
Y1					Cond. fan 1 inverter	Cond. fan 3 inverter
Y2					Cond. fan 2 inverter	Cond. fan 4 inverter
Y3	Cond. fan 1 inverter	Cond. fan 3 inverter	Cond. fan 1 inverter	Cond. fan 3 inverter		
Y4	Cond. fan 2 inverter	Cond. fan 4 inverter	Cond. fan 2 inverter	Cond. fan 4 inverter		

6.12 Chiller units with heat pump and total recovery, configuration "11"

AIR/WATER units with maximum 8 semi-hermetic compressors (1 load step per compressor).

DIGITAL INPUTS

No.	pCO ² /pCO ³ MEDIUM		pCO ¹ MEDIUM		pCO ^c MEDIUM	
	Master (address 1)	Slaves (addresses 2/3/4)	Master (address 1)	Slaves (addresses 2/3/4)	Master (address 1)	Slaves (addresses 2/3/4)
ID 1	Serious alarm	Serious alarm (can be enabled)	Serious alarm	Serious alarm (can be enabled)	Serious alarm	Serious alarm (can be enabled)
ID 2	Evaporator flow switch	Evap. flow switch (can be enabled)	Evaporator flow switch	Evap. flow switch (can be enabled)	Evaporator flow switch	Evap. flow switch (can be enabled)
ID 3	Remote ON/OFF		Remote ON/OFF		Remote ON/OFF	
ID 4	Cooling/heating selection		Cooling/heating selection		Cooling/heating selection	
ID 5	Low press. switch 1	Low press. switch 3	Low press. switch 1	Low press. switch 3	Low press. switch 1	Low press. switch 3
ID 6	Oil differential 1	Oil differential 3	Oil differential 1	Oil differential 3	Oil differential 1	Oil differential 3
ID 7	Fan 1 thermal overload	Fan 3 thermal overload	Fan 1 thermal overload	Fan 3 thermal overload	Fan 1 thermal overload	Fan 3 thermal overload
ID 8	Low press. switch 2	Low press. switch 4	Low press. switch 2	Low press. switch 4	Low press. switch 2	Low press. switch 4
ID 9	Oil differential 2	Oil differential 4	Oil differential 2	Oil differential 4	Oil differential 2	Oil differential 4
ID10						
ID11	Comp. 1 thermal overload	Comp. 3 thermal overload	Comp. 1 thermal overload	Comp. 3 thermal overload	High press. switch 1 / Comp. 1 thermal overload	High press. switch 3 / Comp. 3 thermal overload
ID12	Comp. 2 thermal overload	Comp. 4 thermal overload	Comp. 2 thermal overload	Comp. 4 thermal overload	High press. switch 2 / Comp. 2 thermal overload	High press. switch 4 / Comp. 4 thermal overload
ID13	High press. switch 1	High press. switch 3	High press. switch 1	High press. switch 3		
ID14	High press. switch 2	High press. switch 4	High press. switch 2	High press. switch 4		

ANALOGUE INPUTS

No.	pCO ² /pCO ³ MEDIUM		pCO ¹ MEDIUM		pCO ^c MEDIUM	
	Master (address 1)	Slaves (addresses 2/3/4)	Master (address 1)	Slaves (addresses 2/3/4)	Master (address 1)	Slaves (addresses 2/3/4)
B1	Cond. temp. circuit 1	Cond. temp. circuit 3	Recovery inlet temp.		Water inlet temp.	
B2	Cond. temp. circuit 2	Cond. temp. circuit 4	Recovery outlet temp.		Water outlet temp. 1	Water outlet temp. 2
B3	Recovery inlet temp.		High pressure circuit 1	High pressure circuit 3	Cond. temp. circuit 1	Cond. temp. circuit 3
B4	Water inlet temp.		High pressure circuit 2	High pressure circuit 4	Cond. temp. circuit 2	Cond. temp. circuit 4
B5	Water outlet temp. 1	Water outlet temp. 2	Water inlet temp.		Recovery inlet temp.	
B6	Recovery outlet temp.		Water outlet temp. 1	Water outlet temp. 2	Recovery outlet temp.	
B7	High pressure circuit 1	High pressure circuit 3	Cond. temp. circuit 1	Cond. temp. circuit 3	High pressure circuit 1	High pressure circuit 3
B8	High pressure circuit 2	High pressure circuit 4	Cond. temp. circuit 2	Cond. temp. circuit 4	High pressure circuit 2	High pressure circuit 4

DIGITAL OUTPUTS

No.	pCO ² MEDIUM		pCO ¹ MEDIUM		pCO ^c MEDIUM	
	Master (address 1)	Slaves (addresses 2/3/4)	Master (address 1)	Slaves (addresses 2/3/4)	Master (address 1)	Slaves (addresses 2/3/4)
NO1	Winding A comp. 1	Winding A comp. 3	Winding A comp. 1	Winding A comp. 3	Evap. pump 1	
NO2	Winding B comp. 1	Winding B comp. 3	Winding B comp. 1	Winding B comp. 3	Winding A comp. 1	Winding A comp. 3
NO3	Part load comp. 1	Part load comp. 3	Part load comp. 1	Part load comp. 3	Winding B comp. 1	Winding B comp. 3
NO 4	Winding A comp. 2	Winding A comp. 4	Winding A comp. 2	Winding A comp. 4	Valve A	
NO 5	Winding B comp. 2	Winding B comp. 4	Winding B comp. 2	Winding B comp. 4	Part load comp. 1	Part load comp. 3
NO 6	Part load comp. 2	Part load comp. 4	Part load comp. 2	Part load comp. 4	Winding A comp. 2	Winding A comp. 4
NO 7	Evap. pump 1	Evap. pump 2. / Disable fan coil	Evap. pump 1	Evap. pump 2. / Disable fan coil	Winding B comp. 2	Winding B comp. 4
NO 8	General alarm	General alarm	General alarm	General alarm	Valve B	
NO 9	Cond. fan 1 circuit 1/2	Cond. fan circuit 3/4	Cond. fan 1 circuit 1/2	Cond. fan circuit 3/4	Part load comp. 2	Part load comp. 4
NO10	Valve C		Valve C		Antifreeze heater 1	Antifreeze heater 2
NO11	Antifreeze heater 1	Antifreeze heater 2	Antifreeze heater 1	Antifreeze heater 2	General alarm	General alarm
NO12	Valve A		Valve A		Cond. fan 1 circuit 1/2	Cond. fan 1 circuit 3/4
NO13	Valve B		Valve B		Valve C	

ANALOGUE OUTPUTS

No.	pCO ² /pCO ³ MEDIUM		pCO ¹ MEDIUM		pCO ^c MEDIUM	
	Master (address 1)	Slaves (addresses 2/3/4)	Master (address 1)	Slaves (addresses 2/3/4)	Master (address 1)	Slaves (addresses 2/3/4)
Y1					Cond. fan 1 inverter	Cond. fan 3 inverter
Y2						
Y3	Cond. fan 1 inverter	Cond. fan 3 inverter	Cond. fan 1 inverter	Cond. fan 3 inverter		
Y4	Cond. fan 2 inverter	Cond. fan 4 inverter	Cond. fan 2 inverter	Cond. fan 4 inverter		

6.13 Air/air condensing units, configuration "12"

AIR/AIR units with maximum 8 semi-hermetic compressors (1 load step per compressor).

DIGITAL INPUTS

No.	pCO ² /pCO ³ MEDIUM		pCO ¹ MEDIUM		pCO ^c MEDIUM	
	Master (address 1)	Slaves (addresses 2/3/4)	Master (address 1)	Slaves (addresses 2/3/4)	Master (address 1)	Slaves (addresses 2/3/4)
ID 1	Serious alarm	Serious alarm (can be enabled)	Serious alarm	Serious alarm (can be enabled)	Serious alarm	Serious alarm (can be enabled)
ID 2	Evaporator flow switch	Evap. flow switch (can be enabled)	Evaporator flow switch	Evap. flow switch (can be enabled)	Evaporator flow switch	Evap. flow switch (can be enabled)
ID 3	Remote ON/OFF		Remote ON/OFF		Remote ON/OFF	
ID 4	Main fan thermal overload		Main fan thermal overload		Main fan thermal overload	
ID 5	Low press. switch 1	Low press. switch 3	Low press. switch 1	Low press. switch 3	Low press. switch 1	Low press. switch 3
ID 6	Oil differential 1	Oil differential 3	Oil differential 1	Oil differential 3	Oil differential 1	Oil differential 3
ID 7	Fan 1 thermal overload	Fan 3 thermal overload	Fan 1 thermal overload	Fan 3 thermal overload	Fan 1 thermal overload	Fan 3 thermal overload
ID 8	Low press. switch 2	Low press. switch 4	Low press. switch 2	Low press. switch 4	Low press. switch 2	Low press. switch 4
ID 9	Oil differential 2	Oil differential 4	Oil differential 2	Oil differential 4	Oil differential 2	Oil differential 4
ID10	Fan 2 thermal overload	Fan thermal overload 4	Fan 2 thermal overload	Fan thermal overload 4	Fan 2 thermal overload	Fan thermal overload 4
ID11	Comp. 1 thermal overload	Comp. 3 thermal overload	Comp. 1 thermal overload	Comp. 3 thermal overload	High press. switch 1 / Comp. 1 thermal overload	High press. switch 3 / Comp. 3 thermal overload
ID12	Comp. 2 thermal overload	Comp. 4 thermal overload	Comp. 2 thermal overload	Comp. 4 thermal overload	High press. switch 2 / Comp. 2 thermal overload	High press. switch 4 / Comp. 4 thermal overload
ID13	High press. switch 1	High press. switch 3	High press. switch 1	High press. switch 3		
ID14	High press. switch 2	High press. switch 4	High press. switch 2	High press. switch 4		

ANALOGUE INPUTS

No.	pCO ² /pCO ³ MEDIUM		pCO ¹ MEDIUM		pCO ^c MEDIUM	
	Master (address 1)	Slaves (addresses 2/3/4)	Master (address 1)	Slaves (addresses 2/3/4)	Master (address 1)	Slaves (addresses 2/3/4)
B1	Cond. temp. circuit 1	Cond. temp. circuit 3	Remote comp. control			
B2	Cond. temp. circuit 2	Cond. temp. circuit 4			Air outlet temp. 1	Air outlet temp. 2
B3	Remote comp. control		High pressure circuit 1	High pressure circuit 3	Cond. temp. circuit 1	Cond. temp. circuit 3
B4			High pressure circuit 2	High pressure circuit 4	Cond. temp. circuit 2	Cond. temp. circuit 4
B5	Air outlet temp. 1	Air outlet temp. 2			Remote comp. control	
B6			Air outlet temp. 1	Air outlet temp. 2		
B7	High pressure circuit 1	High pressure circuit 3	Cond. temp. circuit 1	Cond. temp. circuit 3	High pressure circuit 1	High pressure circuit 3
B8	High pressure circuit 2	High pressure circuit 4	Cond. temp. circuit 2	Cond. temp. circuit 4	High pressure circuit 2	High pressure circuit 4

DIGITAL OUTPUTS

No.	pCO ² /pCO ³ MEDIUM		pCO ¹ MEDIUM		pCO ^c MEDIUM	
	Master (address 1)	Slaves (addresses 2/3/4)	Master (address 1)	Slaves (addresses 2/3/4)	Master (address 1)	Slaves (addresses 2/3/4)
NO1	Winding A comp. 1	Winding A comp. 3	Winding A comp. 1	Winding A comp. 3	Circulating fan	
NO2	Winding B comp. 1	Winding B comp. 3	Winding B comp. 1	Winding B comp. 3	Winding A comp. 1	Winding A comp. 3
NO3	Part load comp. 1	Part load comp. 3	Part load comp. 1	Part load comp. 3	Winding B comp. 1	Winding B comp. 3
NO4	Winding A comp. 2	Winding A comp. 4	Winding A comp. 2	Winding A comp. 4	Liq. solenoid circuit 1	Liq. solenoid circuit 3
NO5	Winding B comp. 2	Winding B comp. 4	Winding B comp. 2	Winding B comp. 4	Part load comp. 1	Part load comp. 3
NO6	Part load comp. 2	Part load comp. 4	Part load comp. 2	Part load comp. 4	Winding A comp. 2	Winding A comp. 4
NO7	Circulating fan		Circulating fan		Winding B comp. 2	Winding B comp. 4
NO8	General alarm	General alarm	General alarm	General alarm	Liq. solenoid circuit 2	Liq. solenoid circuit 4
NO9	Cond. fan 1 circuit 1	Cond. fan 1 circuit 3	Cond. fan 1 circuit 1	Cond. fan 1 circuit 3	Part load comp. 2	Part load comp. 4
NO10	Cond. fan 1 circuit 2 or Cond. fan 2 circuit 1	Cond. fan 1 circuit 4 or Cond. fan 2 circuit 3	Cond. fan 1 circuit 2 or Cond. fan 2 circuit 1	Cond. fan 1 circuit 4 or Cond. fan 2 circuit 3	Antifreeze heater 1	Antifreeze heater 2
NO11	Antifreeze heater 1	Antifreeze heater 2	Antifreeze heater 1	Antifreeze heater 2	General alarm	General alarm
NO12	Liq. solenoid circuit 1	Liq. solenoid circuit 3	Liq. solenoid circuit 1	Liq. solenoid circuit 3	Cond. fan 1 circuit 1	Cond. fan 1 circuit 3
NO13	Liq. solenoid circuit 2	Liq. solenoid circuit 4	Liq. solenoid circuit 2	Liq. solenoid circuit 4	Cond. fan 1 circuit 2 or Cond. fan 2 circuit 1	Cond. fan 1 circuit 4 or Cond. fan 2 circuit 3

ANALOGUE OUTPUTS

No.	pCO ² /pCO ³ MEDIUM		pCO ¹ MEDIUM		pCO ^c MEDIUM	
	Master (address 1)	Slaves (addresses 2/3/4)	Master (address 1)	Slaves (addresses 2/3/4)	Master (address 1)	Slaves (addresses 2/3/4)
Y1					Cond. fan 1 inverter	Cond. fan 3 inverter
Y2					Cond. fan 2 inverter	Cond. fan 4 inverter
Y3	Cond. fan 1 inverter	Cond. fan 3 inverter	Cond. fan 1 inverter	Cond. fan 3 inverter		
Y4	Cond. fan 2 inverter	Cond. fan 4 inverter	Cond. fan 2 inverter	Cond. fan 4 inverter		

6.14 Chiller units with heat pump and condenser, configuration "13"

AIR/AIR units with maximum 8 semi-hermetic compressors (1 load step per compressor).

DIGITAL INPUTS

No.	pCO ² /pCO ³ MEDIUM		pCO ¹ MEDIUM		pCO ^c MEDIUM	
	Master (address 1)	Slaves (addresses 2/3/4)	Master (address 1)	Slaves (addresses 2/3/4)	Master (address 1)	Slaves (addresses 2/3/4)
ID 1	Serious alarm	Serious alarm (can be enabled)	Serious alarm	Serious alarm (can be enabled)	Serious alarm	Serious alarm (can be enabled)
ID 2	Evaporator flow switch	Evap. flow switch (can be enabled)	Evaporator flow switch	Evap. flow switch (can be enabled)	Evaporator flow switch	Evap. flow switch (can be enabled)
ID 3	Remote ON/OFF		Remote ON/OFF		Remote ON/OFF	
ID 4	Cooling/heating selection		Cooling/heating selection		Cooling/heating selection	
ID 5	Low press. switch 1	Low press. switch 3	Low press. switch 1	Low press. switch 3	Low press. switch 1	Low press. switch 3
ID 6	Oil differential 1	Oil differential 3	Oil differential 1	Oil differential 3	Oil differential 1	Oil differential 3
ID 7	Fan 1 thermal overload	Fan 3 thermal overload	Fan 1 thermal overload	Fan 3 thermal overload	Fan 1 thermal overload	Fan 3 thermal overload
ID 8	Low press. switch 2	Low press. switch 4	Low press. switch 2	Low press. switch 4	Low press. switch 2	Low press. switch 4
ID 9	Oil differential 2	Oil differential 4	Oil differential 2	Oil differential 4	Oil differential 2	Oil differential 4
ID10	Fan 2 thermal overload	Fan thermal overload 4	Fan 2 thermal overload	Fan thermal overload 4	Fan 2 thermal overload	Fan thermal overload 4
ID11	Comp. 1 thermal overload	Comp. 3 thermal overload	Comp. 1 thermal overload	Comp. 3 thermal overload	High press. switch 1 / Comp. 1 thermal overload	High press. switch 3 / Comp. 3 thermal overload
ID12	Comp. 2 thermal overload	Comp. 4 thermal overload	Comp. 2 thermal overload	Comp. 4 thermal overload	High press. switch 2 / Comp. 2 thermal overload	High press. switch 4 / Comp. 4 thermal overload
ID13	High press. switch 1	High press. switch 3	High press. switch 1	High press. switch 3		
ID14	High press. switch 2	High press. switch 4	High press. switch 2	High press. switch 4		

ANALOGUE INPUTS

No.	pCO ² /pCO ³ MEDIUM		pCO ¹ MEDIUM		pCO ^c MEDIUM	
	Master (address 1)	Slaves (addresses 2/3/4)	Master (address 1)	Slaves (addresses 2/3/4)	Master (address 1)	Slaves (addresses 2/3/4)
B1	Cond. temp. circuit 1	Cond. temp. circuit 3	Remote comp. control			
B2	Cond. temp. circuit 2	Cond. temp. circuit 4			Air outlet temp. 1	Air outlet temp. 2
B3	Remote comp. control		High pressure circuit 1	High pressure circuit 3	Cond. temp. circ 1	Cond. temp. circuit 3
B4			High pressure circuit 2	High pressure circuit 4	Cond. temp. circ 2	Cond. temp. circuit 4
B5	Air outlet temp. 1	Air outlet temp. 2			Remote comp. control	
B6			Air outlet temp. 1	Air outlet temp. 2		
B7	High pressure circuit 1	High pressure circuit 3	Cond. temp. circuit 1	Cond. temp. circuit 3	High press. transducers circ. 1	High press. transducers circ. 3
B8	High pressure circuit 2	High pressure circuit 4	Cond. temp. circuit 2	Cond. temp. circuit 4	High press. transducers circ. 2	High press. transducers circ. 4

DIGITAL OUTPUTS

No.	pCO ² /pCO ³ MEDIUM		pCO ¹ MEDIUM		pCO ^c MEDIUM	
	Master (address 1)	Slaves (addresses 2/3/4)	Master (address 1)	Slaves (addresses 2/3/4)	Master (address 1)	Slaves (addresses 2/3/4)
NO1	Winding A comp. 1	Winding A comp. 3	Winding A comp. 1	Winding A comp. 3	Main fan	
NO2	Winding B comp. 1	Winding B comp. 3	Winding B comp. 1	Winding B comp. 3	Winding A comp. 1	Winding A comp. 3
NO3	Part load comp. 1	Part load comp. 3	Part load comp. 1	Part load comp. 3	Winding B comp. 1	Winding B comp. 3
NO 4	Winding A comp. 2	Winding A comp. 4	Winding A comp. 2	Winding A comp. 4	4-way valve C1	4-way valve C3
NO 5	Winding B comp. 2	Winding B comp. 4	Winding B comp. 2	Winding B comp. 4	Part load comp. 1	Part load comp. 3
NO 6	Part load comp. 2	Part load comp. 4	Part load comp. 2	Part load comp. 4	Winding A comp. 2	Winding A comp. 4
NO 7	Main fan		Main fan		Winding B comp. 2	Winding B comp. 4
NO 8	General alarm	General alarm	General alarm	General alarm	4-way valve C2	4-way valve C4
NO 9	Cond. fan C1	Cond. fan C1	Cond. fan C1	Cond. fan C1	Part load comp. 2	Part load comp. 4
NO10	Cond. fan C2	Cond. fan C2	Cond. fan C2	Cond. fan C2	Antifreeze heater 1	Antifreeze heater 2
NO11	Antifreeze heater 1	Antifreeze heater 2	Antifreeze heater 1	Antifreeze heater 2	General alarm	General alarm
NO12	4-way valve C1	4-way valve C3	4-way valve C1	4-way valve C3	Cond. fan C1	Cond. fan C3
NO13	4-way valve C2	4-way valve C4	4-way valve C2	4-way valve C4	Cond. fan C2	Cond. fan C4

ANALOGUE OUTPUTS

No.	pCO ² /pCO ³ MEDIUM		pCO ¹ MEDIUM		pCO ^c MEDIUM	
	Master (address 1)	Slaves (addresses 2/3/4)	Master (address 1)	Slaves (addresses 2/3/4)	Master (address 1)	Slaves (addresses 2/3/4)
Y1					Cond. fan 1 inverter	Cond. fan 3 inverter
Y2					Cond. fan 2 inverter	Cond. fan 4 inverter
Y3	Cond. fan 1 inverter	Cond. fan 3 inverter	Cond. fan 1 inverter	Cond. fan 3 inverter		
Y4	Cond. fan 2 inverter	Cond. fan 4 inverter	Cond. fan 2 inverter	Cond. fan 4 inverter		

6.15 Chiller-only units, configuration "14"

WATER/WATER units with maximum 8 semi-hermetic compressors (1 load step per compressor).

DIGITAL INPUTS

No.	pCO ² /pCO ³ MEDIUM		pCO ¹ MEDIUM		pCO ^c MEDIUM	
	Master (address 1)	Slaves (addresses 2/3/4)	Master (address 1)	Slaves (addresses 2/3/4)	Master (address 1)	Slaves (addresses 2/3/4)
ID 1	Serious alarm	Serious alarm (can be enabled)	Serious alarm	Serious alarm (can be enabled)	Serious alarm	Serious alarm (can be enabled)
ID 2	Evaporator flow switch	Evap. flow switch (can be enabled)	Evaporator flow switch	Evap. flow switch (can be enabled)	Evaporator flow switch	Evap. flow switch (can be enabled)
ID 3	Remote ON/OFF		Remote ON/OFF		Remote ON/OFF	
ID 4	Pump 1 thermal overload	Pump 2 thermal overload	Pump 1 thermal overload	Pump 2 thermal overload	Pump thermal overload	
ID 5	Low press. switch 1	Low press. switch 3	Low press. switch 1	Low press. switch 3	Low press. switch 1	Low press. switch 3
ID 6	Oil differential 1	Oil differential 3	Oil differential 1	Oil differential 3	Oil differential 1	Oil differential 3
ID 7	Cond. water flow switch	Cond. water flow switch (can be enabled)	Cond. water flow switch	Cond. water flow switch (can be enabled)	Cond. water flow switch	Cond. water flow switch (can be enabled)
ID 8	Low press. switch 2	Low press. switch 4	Low press. switch 2	Low press. switch 4	Low press. switch 2	Low press. switch 4
ID 9	Oil differential 2	Oil differential 4	Oil differential 2	Oil differential 4	Oil differential 2	Oil differential 4
ID10	Cond. pump thermal overload		Cond. pump thermal overload		Cond. pump thermal overload	
ID11	Comp. 1 thermal overload	Comp. 3 thermal overload	Comp. 1 thermal overload	Comp. 3 thermal overload	High press. switch 1 / Comp. 1 thermal overload	High press. switch 3 / Comp. 3 thermal overload
ID12	Comp. 2 thermal overload	Comp. 4 thermal overload	Comp. 2 thermal overload	Comp. 4 thermal overload	High press. switch 2 / Comp. 2 thermal overload	High press. switch 4 / Comp. 4 thermal overload
ID13	High press. switch 1	High press. switch 3	High press. switch 1	High press. switch 3		
ID14	High press. switch 2	High press. switch 4	High press. switch 2	High press. switch 4		

ANALOGUE INPUTS

No.	pCO ² /pCO ³ MEDIUM		pCO ¹ MEDIUM		pCO ^c MEDIUM	
	Master (address 1)	Slaves (addresses 2/3/4)	Master (address 1)	Slaves (addresses 2/3/4)	Master (address 1)	Slaves (addresses 2/3/4)
B1	Cond. inlet temp. 1	Evap. water outlet temp. 2	Outside set point		Evap. water inlet temp.	
B2	Cond. outlet temp. 1	Cond. inlet temp. 2			Evap. water outlet temp. 1	Evap. water outlet temp. 2
B3	Outside set point	Cond. outlet temp. 2	High pressure circuit 1	High pressure circuit 3	Cond. inlet temp. 1	Cond. inlet temp. 2
B4	Evap. water inlet temp.		High pressure circuit 2	High pressure circuit 4	Cond. outlet temp. 1	Cond. outlet temp. 2
B5	Evap. water outlet temp. 1	Evap. water outlet temp. 2	Evap. water inlet temp.		Outside set point	
B6			Evap. water outlet temp. 1	Evap. water outlet temp. 2		
B7	High pressure circuit 1	High pressure circuit 3	Cond. inlet temp. 1	Cond. inlet temp. 2	High pressure circuit 1	High pressure circuit 3
B8	High pressure circuit 2	High pressure circuit 4	Cond. outlet temp. 1	Cond. outlet temp. 2	High pressure circuit 2	High pressure circuit 4

DIGITAL OUTPUTS

No.	pCO ² /pCO ³ MEDIUM		pCO ¹ MEDIUM		pCO ^c MEDIUM	
	Master (address 1)	Slaves (addresses 2/3/4)	Master (address 1)	Slaves (addresses 2/3/4)	Master (address 1)	Slaves (addresses 2/3/4)
NO1	Winding A comp. 1	Winding A comp. 3	Winding A comp. 1	Winding A comp. 3	Evap. pump 1	
NO2	Winding B comp. 1	Winding B comp. 3	Winding B comp. 1	Winding B comp. 3	Winding A comp. 1	Winding A comp. 3
NO3	Part load comp. 1	Part load comp. 3	Part load comp. 1	Part load comp. 3	Winding B comp. 1	Winding B comp. 3
NO 4	Winding A comp. 2	Winding A comp. 4	Winding A comp. 2	Winding A comp. 4	Liq. solenoid circuit 1	Liq. solenoid circuit 3
NO 5	Winding B comp. 2	Winding B comp. 4	Winding B comp. 2	Winding B comp. 4	Part load comp. 1	Part load comp. 3
NO 6	Part load comp. 2	Part load comp. 4	Part load comp. 2	Part load comp. 4	Winding A comp. 2	Winding A comp. 4
NO 7	Evap. pump 1	Evap. pump 2. / Disable fan coil	Evap. pump 1	Evap. pump 2. / Disable fan coil	Winding B comp. 2	Winding B comp. 4
NO 8	General alarm	General alarm	General alarm	General alarm	Liq. solenoid circuit 2	Liq. solenoid circuit 4
NO 9	Condenser pump		Condenser pump		Part load comp. 2	Part load comp. 4
NO10					Antifreeze heater 1	Antifreeze heater 2
NO11	Antifreeze heater 1	Antifreeze heater 2	Antifreeze heater 1	Antifreeze heater 2	General alarm	General alarm
NO12	Liq. solenoid circuit 1	Liq. solenoid circuit 3	Liq. solenoid circuit 1	Liq. solenoid circuit 3	Condenser pump	
NO13	Liq. solenoid circuit 2	Liq. solenoid circuit 4	Liq. solenoid circuit 2	Liq. solenoid circuit 4		

ANALOGUE OUTPUTS

No.	pCO ² /pCO ³ MEDIUM		pCO ¹ MEDIUM		pCO ^c MEDIUM	
	Master (address 1)	Slaves (addresses 2/3/4)	Master (address 1)	Slaves (addresses 2/3/4)	Master (address 1)	Slaves (addresses 2/3/4)
Y1						
Y2						
Y3						
Y4						

6.16 Cooling/heating units with reversal on the water circuit, configuration "15"

WATER/WATER units with maximum 8 semi-hermetic compressors (1 load step per compressor).

DIGITAL INPUTS

No.	pCO ² /pCO ³ MEDIUM		pCO ¹ MEDIUM		pCO ^c MEDIUM	
	Master (address 1)	Slaves (addresses 2/3/4)	Master (address 1)	Slaves (addresses 2/3/4)	Master (address 1)	Slaves (addresses 2/3/4)
ID 1	Serious alarm	Serious alarm (can be enabled)	Serious alarm	Serious alarm (can be enabled)	Serious alarm	Serious alarm (can be enabled)
ID 2	Evaporator flow switch	Evap. flow switch (can be enabled)	Evaporator flow switch	Evap. flow switch (can be enabled)	Evaporator flow switch	Evap. flow switch (can be enabled)
ID 3	Remote ON/OFF		Remote ON/OFF		Remote ON/OFF	
ID 4	Cooling/heating selection		Cooling/heating selection		Cooling/heating selection	
ID 5	Low press. switch 1	Low press. switch 3	Low press. switch 1	Low press. switch 3	Low press. switch 1	Low press. switch 3
ID 6	Oil differential 1	Oil differential 3	Oil differential 1	Oil differential 3	Oil differential 1	Oil differential 3
ID 7	Cond. water flow switch	Cond. water flow switch (can be enabled)	Cond. water flow switch	Cond. water flow switch (can be enabled)	Cond. water flow switch	Cond. water flow switch (can be enabled)
ID 8	Low press. switch 2	Low press. switch 4	Low press. switch 2	Low press. switch 4	Low press. switch 2	Low press. switch 4
ID 9	Oil differential 2	Oil differential 4	Oil differential 2	Oil differential 4	Oil differential 2	Oil differential 4
ID10	Cond. pump thermal overload		Cond. pump thermal overload		Cond. pump thermal overload	
ID11	Comp. 1 thermal overload	Comp. 3 thermal overload	Comp. 1 thermal overload	Comp. 3 thermal overload	High press. switch 1 / Comp. 1 thermal overload	High press. switch 3 / Comp. 3 thermal overload
ID12	Comp. 2 thermal overload	Comp. 4 thermal overload	Comp. 2 thermal overload	Comp. 4 thermal overload	High press. switch 2 / Comp. 2 thermal overload	High press. switch 4 / Comp. 4 thermal overload
ID13	High press. switch 1	High press. switch 3	High press. switch 1	High press. switch 3		
ID14	High press. switch 2	High press. switch 4	High press. switch 2	High press. switch 4		

ANALOGUE INPUTS

No.	pCO ² /pCO ³ MEDIUM		pCO ¹ MEDIUM		pCO ^c MEDIUM	
	Master (address 1)	Slaves (addresses 2/3/4)	Master (address 1)	Slaves (addresses 2/3/4)	Master (address 1)	Slaves (addresses 2/3/4)
B1	Cond. inlet temp. 1	Cond. inlet temp. 2	Outside set point		Evap. water inlet temp.	
B2	Cond. outlet temp. 1	Cond. outlet temp. 2			Evap. water outlet temp. 1	Evap. water outlet temp. 2
B3	Outside set point		High pressure circuit 1	High pressure circuit 3	Cond. inlet temp. 1	Cond. inlet temp. 2
B4	Evap. water inlet temp.		High pressure circuit 2	High pressure circuit 4	Cond. outlet temp. 1	Cond. outlet temp. 2
B5	Evap. water outlet temp. 1	Evap. water outlet temp. 2	Evap. water inlet temp.		Outside set point	
B6			Evap. water outlet temp. 1	Evap. water outlet temp. 2		
B7	High pressure circuit 1	High pressure circuit 3	Cond. inlet temp. 1	Cond. inlet temp. 2	High pressure circuit 1	High pressure circuit 3
B8	High pressure circuit 2	High pressure circuit 4	Cond. outlet temp. 1	Cond. outlet temp. 2	High pressure circuit 2	High pressure circuit 4

DIGITAL OUTPUTS

No.	pCO ² /pCO ³ MEDIUM		pCO ¹ MEDIUM		pCO ^c MEDIUM	
	Master (address 1)	Slaves (addresses 2/3/4)	Master (address 1)	Slaves (addresses 2/3/4)	Master (address 1)	Slaves (addresses 2/3/4)
NO1	Winding A comp. 1	Winding A comp. 3	Winding A comp. 1	Winding A comp. 3	Evap. pump 1	
NO2	Winding B comp. 1	Winding B comp. 3	Winding B comp. 1	Winding B comp. 3	Winding A comp. 1	Winding A comp. 3
NO3	Part load comp. 1	Part load comp. 3	Part load comp. 1	Part load comp. 3	Winding B comp. 1	Winding B comp. 3
NO4	Winding A comp. 2	Winding A comp. 4	Winding A comp. 2	Winding A comp. 4	Liq. solenoid circuit 1	Liq. solenoid circuit 3
NO5	Winding B comp. 2	Winding B comp. 4	Winding B comp. 2	Winding B comp. 4	Part load comp. 1	Part load comp. 3
NO6	Part load comp. 2	Part load comp. 4	Part load comp. 2	Part load comp. 4	Winding A comp. 2	Winding A comp. 4
NO7	Evap. pump 1	Evap. pump 2. / Disable fan coil	Evap. pump 1	Evap. pump 2. / Disable fan coil	Winding B comp. 2	Winding B comp. 4
NO8	General alarm	General alarm	General alarm	General alarm	Liq. solenoid circuit 2	Liq. solenoid circuit 4
NO9	Condenser pump		Condenser pump		Part load comp. 2	Part load comp. 4
NO10	Heat / cool valve		Heat / cool valve		Antifreeze heater 1	Antifreeze heater 2
NO11	Antifreeze heater 1	Antifreeze heater 2	Antifreeze heater 1	Antifreeze heater 2	General alarm	General alarm
NO12	Liquid solenoid circ.1	Liq. solenoid circuit 3	Liquid solenoid circ.1	Liq. solenoid circuit 3	Condenser pump	
NO13	Liquid solenoid circ.2	Liq. solenoid circuit 4	Liquid solenoid circ.2	Liq. solenoid circuit 4	Heat / cool valve	

ANALOGUE OUTPUTS

No.	pCO ² /pCO ³ MEDIUM		pCO ¹ MEDIUM		pCO ^c MEDIUM	
	Master (address 1)	Slaves (addresses 2/3/4)	Master (address 1)	Slaves (addresses 2/3/4)	Master (address 1)	Slaves (addresses 2/3/4)
Y1						
Y2						
Y3						
Y4						

6.17 Chiller-only units, configuration "16"

AIR/WATER units with maximum 4 semi-hermetic compressors (up to 3 load steps per comp.).

DIGITAL INPUTS

No.	pCO ² /pCO ³ MEDIUM		pCO ¹ MEDIUM		pCO ^c MEDIUM	
	Master (address 1)	Slaves (addresses 2/3/4)	Master (address 1)	Slaves (addresses 2/3/4)	Master (address 1)	Slaves (addresses 2/3/4)
ID 1	Serious alarm	Serious alarm (can be enabled)	Serious alarm	Serious alarm (can be enabled)	Serious alarm	Serious alarm (can be enabled)
ID 2	Evaporator flow switch	Evap. flow switch (can be enabled)	Evaporator flow switch	Evap. flow switch (can be enabled)	Evaporator flow switch	Evap. flow switch (can be enabled)
ID 3	Remote ON/OFF		Remote ON/OFF		Remote ON/OFF	
ID 4	Pump 1 thermal overload	Pump 2 thermal overload	Pump 1 thermal overload	Pump 2 thermal overload	Pump thermal overload	
ID 5	Low pressure switch 1	Low pressure switch 2	Low pressure switch 1	Low pressure switch 2	Low pressure switch 1	Low pressure switch 2
ID 6	Oil differential 1	Oil differential 2	Oil differential 1	Oil differential 2	Oil differential 1	Oil differential 2
ID 7	Fan 1 thermal overload circuit 1	Fan 1 thermal overload circuit 2	Fan 1 thermal overload circuit 1	Fan 1 thermal overload circuit 2	Fan 1 thermal overload circuit 1	Fan 1 thermal overload circuit 2
ID 8	Fan 2 thermal overload circuit 1	Fan 2 thermal overload circuit 2	Fan 2 thermal overload circuit 1	Fan 2 thermal overload circuit 2	Fan 2 thermal overload circuit 1	Fan 2 thermal overload circuit 2
ID 9	Fan 3 thermal overload circuit 1	Fan 3 thermal overload circuit 2	Fan 3 thermal overload circuit 1	Fan 3 thermal overload circuit 2	Fan 3 thermal overload circuit 1	Fan 3 thermal overload circuit 2
ID10						
ID11					High pressure switch 1	High pressure switch 2
ID12					Comp. 1 thermal overload	Comp. 3 thermal overload
ID13	High pressure switch 1	High pressure switch 2	High pressure switch 1	High pressure switch 2		
ID14	Comp. 1 thermal overload	Comp. 3 thermal overload	Comp. 1 thermal overload	Comp. 3 thermal overload		

ANALOGUE INPUTS

No.	pCO ² /pCO ³ MEDIUM		pCO ¹ MEDIUM		pCO ^c MEDIUM	
	Master (address 1)	Slaves (addresses 2/3/4)	Master (address 1)	Slaves (addresses 2/3/4)	Master (address 1)	Slaves (addresses 2/3/4)
B1	Cond. temp. circuit 1	Cond. temp. circuit 2	Outside set point		Water inlet temp.	
B2					Water outlet temp. 1	Water outlet temp. 2
B3	Outside set point		High pressure circuit 1	High pressure circuit 2	Cond. temp. circuit 1	Cond. temp. circuit 2
B4	Water inlet temp.					
B5	Water outlet temp. 1	Water outlet temp. 2	Water inlet temp.		Outside set point	
B6			Water outlet temp. 1	Water outlet temp. 2		
B7	High pressure circuit 1	High pressure circuit 2	Cond. temp. circuit 1	Cond. temp. circuit 2	High pressure circuit 1	High pressure circuit 2
B8						

DIGITAL OUTPUTS

No.	pCO ² /pCO ³ MEDIUM		pCO ¹ MEDIUM		pCO ^c MEDIUM	
	Master (address 1)	Slaves (addresses 2/3/4)	Master (address 1)	Slaves (addresses 2/3/4)	Master (address 1)	Slaves (addresses 2/3/4)
NO1	Winding A comp. 1	Winding A comp. 2	Winding A comp. 1	Winding A comp. 2	Evap. pump 1	
NO2	Winding B comp. 1	Winding B comp. 2	Winding B comp. 1	Winding B comp. 2	Winding A comp. 1	Winding A comp. 2
NO3	Load step 1 comp. 1	Load step 1 comp. 2	Load step 1 comp. 1	Load step 1 comp. 2	Winding B comp. 1	Winding B comp. 2
NO 4	Load step 2 comp. 1	Load step 2 comp. 2	Load step 2 comp. 1	Load step 2 comp. 2	Liq. solenoid circuit 1	Liq. solenoid circuit 2
NO 5	Load step 3 comp. 1	Load step 3 comp. 2	Load step 3 comp. 1	Load step 3 comp. 2	Cond. fan 3 circ. 1	Cond. fan 3 circ. 2
NO 6	Liq. solenoid circuit 1	Liq. solenoid circuit 2	Liq. solenoid circuit 1	Liq. solenoid circuit 2	Load step 1 comp. 1	Load step 1 comp. 2
NO 7	Evap. pump 1	Evap. pump 2. / Disable fan coil	Evap. pump 1	Evap. pump 2. / Disable fan coil	Load step 2 comp. 1	Load step 2 comp. 2
NO 8	General alarm	General alarm	General alarm	General alarm	Load step 3 comp. 1	Load step 3 comp. 2
NO 9	Cond. fan 1 circ. 1	Cond. fan 1 circ. 2	Cond. fan 1 circ. 1	Cond. fan 1 circ. 2	Cond. fan 2 circ. 1	Cond. fan 2 circ. 2
NO10	Cond. fan 2 circ. 1	Cond. fan 2 circ. 2	Cond. fan 2 circ. 1	Cond. fan 2 circ. 2	Antifreeze heater 1	Antifreeze heater 2
NO11	Cond. fan 3 circ. 1	Cond. fan 3 circ. 2	Cond. fan 3 circ. 1	Cond. fan 3 circ. 2	General alarm	General alarm
NO12					Cond. fan 1 circ. 1	Cond. fan 1 circ. 2
NO13	Antifreeze heater 1	Antifreeze heater 2	Antifreeze heater 1	Antifreeze heater 2		

ANALOGUE OUTPUTS

No.	pCO ² /pCO ³ MEDIUM		pCO ¹ MEDIUM		pCO ^c MEDIUM	
	Master (address 1)	Slaves (addresses 2/3/4)	Master (address 1)	Slaves (addresses 2/3/4)	Master (address 1)	Slaves (addresses 2/3/4)
Y1					Cond. fan inverter1	Cond. fan 2 inverter
Y2						
Y3	Cond. fan 1 inverter	Cond. fan 2 inverter	Cond. fan inverter1	Cond. fan 2 inverter		
Y4						

6.18 Chiller units with freecooling, configuration "17"

AIR/WATER units with maximum 4 semi-hermetic compressors (up to 3 load steps per comp.).

DIGITAL INPUTS

No.	pCO ² /pCO ³ MEDIUM		pCO ¹ MEDIUM		pCO ^c MEDIUM	
	Master (address 1)	Slaves (addresses 2/3/4)	Master (address 1)	Slaves (addresses 2/3/4)	Master (address 1)	Slaves (addresses 2/3/4)
ID 1	Serious alarm	Serious alarm (can be enabled)	Serious alarm	Serious alarm (can be enabled)	Serious alarm	Serious alarm (can be enabled)
ID 2	Evaporator flow switch	Evap. flow switch (can be enabled)	Evaporator flow switch	Evap. flow switch (can be enabled)	Evaporator flow switch	Evap. flow switch (can be enabled)
ID 3	Remote ON/OFF		Remote ON/OFF		Remote ON/OFF	
ID 4	Pump 1 thermal overload	Pump 2 thermal overload	Pump 1 thermal overload	Pump 2 thermal overload	Pump thermal overload	
ID 5	Low press. switch 1	Low press. switch 2	Low press. switch 1	Low press. switch 2	Low press. switch 1	Low press. switch 2
ID 6	Oil differential 1	Oil differential 2	Oil differential 1	Oil differential 2	Oil differential 1	Oil differential 2
ID 7	Fan 1 thermal overload circuit 1	Fan 1 thermal overload circuit 2	Fan 1 thermal overload circuit 1	Fan 1 thermal overload circuit 2	Fan 1 thermal overload circuit 1	Fan 1 thermal overload circuit 2
ID 8	Fan 2 thermal overload circuit 1	Fan 2 thermal overload circuit 2	Fan 2 thermal overload circuit 1	Fan 2 thermal overload circuit 2	Fan 2 thermal overload circuit 1	Fan 2 thermal overload circuit 2
ID 9	Fan 3 thermal overload circuit 1	Fan 3 thermal overload circuit 2	Fan 3 thermal overload circuit 1	Fan 3 thermal overload circuit 2	Fan 3 thermal overload circuit 1	Fan 3 thermal overload circuit 2
ID10						
ID11					High press. switch 1	High press. switch 2
ID12					Comp. 1 thermal overload	Comp. 3 thermal overload
ID13	High press. switch 1	High press. switch 2	High press. switch 1	High press. switch 2		
ID14	Comp. 1 thermal overload	Comp. 3 thermal overload	Comp. 1 thermal overload	Comp. 3 thermal overload		

ANALOGUE INPUTS

No.	pCO ² /pCO ³ MEDIUM		pCO ¹ MEDIUM		pCO ^c MEDIUM	
	Master (address 1)	Slaves (addresses 2/3/4)	Master (address 1)	Slaves (addresses 2/3/4)	Master (address 1)	Slaves (addresses 2/3/4)
B1	Cond. temp. circuit 1	Cond. temp. circuit 2	Outside set point		Water inlet temp.	
B2	Outside temperature		Freecooling temperature		Water outlet temp. 1	Water outlet temp. 2
B3	Outside set point		High pressure circuit 1	High pressure circuit 2	Cond. temp. circuit 1	Cond. temp. circuit 2
B4	Water inlet temp.				Outside temperature	
B5	Water outlet temp. 1	Water outlet temp. 2	Water inlet temp.		Outside set point	
B6	Freecooling temperature		Water outlet temp. 1	Water outlet temp. 2	Freecooling temperature	
B7	High pressure circuit 1	High pressure circuit 2	Cond. temp. circuit 1	Cond. temp. circuit 2	High pressure circuit 1	High pressure circuit 2
B8			Outside temperature			

DIGITAL OUTPUTS

No.	pCO ² /pCO ³ MEDIUM		pCO ¹ MEDIUM		pCO ^c MEDIUM	
	Master (address 1)	Slaves (addresses 2/3/4)	Master (address 1)	Slaves (addresses 2/3/4)	Master (address 1)	Slaves (addresses 2/3/4)
NO1	Winding A comp. 1	Winding A comp. 2	Winding A comp. 1	Winding A comp. 2	Evap. pump 1	
NO2	Winding B comp. 1	Winding B comp. 2	Winding B comp. 1	Winding B comp. 2	Winding A comp. 1	Winding A comp. 2
NO3	Load step 1 comp. 1	Load step 1 comp. 2	Load step 1 comp. 1	Load step 1 comp. 2	Winding B comp. 1	Winding B comp. 2
NO 4	Load step 2 comp. 1	Load step 2 comp. 2	Load step 2 comp. 1	Load step 2 comp. 2	Liq. solenoid circuit 1	Liq. solenoid circuit 2
NO 5	Load step 3 comp. 1	Load step 3 comp. 2	Load step 3 comp. 1	Load step 3 comp. 2	Cond. fan 3 circ. 1	Cond. fan 3 circ. 2
NO 6	Liq. solenoid circuit 1	Liq. solenoid circuit 2	Liq. solenoid circuit 1	Liq. solenoid circuit 2	Load step 1 comp. 1	Load step 1 comp. 2
NO 7	Evap. pump 1	Evap. pump 2. / Disable fan coil	Evap. pump 1	Evap. pump 2. / Disable fan coil	Load step 2 comp. 1	Load step 2 comp. 2
NO 8	General alarm	General alarm	General alarm	General alarm	Load step 3 comp. 1	Load step 3 comp. 2
NO 9	Cond. fan 1 circ. 1	Cond. fan 1 circ. 2	Cond. fan 1 circ. 1	Cond. fan 1 circ. 2	Cond. fan 2 circ. 1	Cond. fan 2 circ. 2
NO10	Cond. fan 2 circ. 1	Cond. fan 2 circ. 2	Cond. fan 2 circ. 1	Cond. fan 2 circ. 2	Antifreeze heater 1	Antifreeze heater 2
NO11	Cond. fan 3 circ. 1	Cond. fan 3 circ. 2	Cond. fan 3 circ. 1	Cond. fan 3 circ. 2	General alarm	General alarm
NO12	On / off freecooling		On / off freecooling		Cond. fan 1 circ. 1	Cond. fan 1 circ. 2
NO13	Antifreeze heater 1	Antifreeze heater 2	Antifreeze heater 1	Antifreeze heater 2	On / off freecooling	

ANALOGUE OUTPUTS

No.	pCO ² /pCO ³ MEDIUM		pCO ¹ MEDIUM		pCO ^c MEDIUM	
	Master (address 1)	Slaves (addresses 2/3/4)	Master (address 1)	Slaves (addresses 2/3/4)	Master (address 1)	Slaves (addresses 2/3/4)
Y1	Modul. freecooling valve		Modul. freecooling valve		Cond. fan inverter1	Cond. fan 2 inverter
Y2					Modul. freecooling valve	
Y3	Cond. fan inverter1	Cond. fan 2 inverter	Cond. fan 1 inverter	Cond. fan 2 inverter		
Y4						

6.19 Chiller units with heat pump, configuration "18"

AIR/WATER units with maximum 4 semi-hermetic compressors (up to 3 load steps per comp.).

DIGITAL INPUTS

No.	pCO ² /pCO ³ MEDIUM		pCO ¹ MEDIUM		pCO ^c MEDIUM	
	Master (address 1)	Slaves (addresses 2/3/4)	Master (address 1)	Slaves (addresses 2/3/4)	Master (address 1)	Slaves (addresses 2/3/4)
ID 1	Serious alarm	Serious alarm (can be enabled)	Serious alarm	Serious alarm (can be enabled)	Serious alarm	Serious alarm (can be enabled)
ID 2	Evaporator flow switch	Evap. flow switch (can be enabled)	Evaporator flow switch	Evap. flow switch (can be enabled)	Evaporator flow switch	Evap. flow switch (can be enabled)
ID 3	Remote ON/OFF		Remote ON/OFF		Remote ON/OFF	
ID 4	Pump 1 thermal overload	Pump 2 thermal overload	Pump 1 thermal overload	Pump 2 thermal overload	Cooling/heating selection	
ID 5	Low press. switch 1	Low press. switch 2	Low press. switch 1	Low press. switch 2	Low press. switch 1	Low press. switch 2
ID 6	Oil differential 1	Oil differential 2	Oil differential 1	Oil differential 2	Oil differential 1	Oil differential 2
ID 7	Fan 1 thermal overload circuit 1	Fan 1 thermal overload circuit 2	Fan 1 thermal overload circuit 1	Fan 1 thermal overload circuit 2	Fan 1 thermal overload circuit 1	Fan 1 thermal overload circuit 2
ID 8	Fan 2 thermal overload circuit 1	Fan 2 thermal overload circuit 2	Fan 2 thermal overload circuit 1	Fan 2 thermal overload circuit 2	Fan 2 thermal overload circuit 1	Fan 2 thermal overload circuit 2
ID 9	Fan 3 thermal overload circuit 1	Fan 3 thermal overload circuit 2	Fan 3 thermal overload circuit 1	Fan 3 thermal overload circuit 2	Fan 3 thermal overload circuit 1	Fan 3 thermal overload circuit 2
ID 10					Pump thermal overload	
ID 11	Cooling/heating selection		Cooling/heating selection		High press. switch 1	High press. switch 2
ID 12					Comp. 1 thermal overload	Comp. 2 thermal overload
ID 13	High press. switch 1	High press. switch 2	High press. switch 1	High press. switch 2		
ID 14	Comp. 1 thermal overload	Comp. 2 thermal overload	Comp. 1 thermal overload	Comp. 2 thermal overload		

ANALOGUE INPUTS

No.	pCO ² /pCO ³ MEDIUM		pCO ¹ MEDIUM		pCO ^c MEDIUM	
	Master (address 1)	Slaves (addresses 2/3/4)	Master (address 1)	Slaves (addresses 2/3/4)	Master (address 1)	Slaves (addresses 2/3/4)
B1	Cond. temp. circuit 1	Cond. temp. circuit 2	Outside set point		Water inlet temp.	
B2					Water outlet temp. 1	Water outlet temp. 2
B3	Outside set point		High pressure circuit 1	High pressure circuit 2	Cond. temp. circuit 1	Cond. temp. circuit 2
B4	Water inlet temp.					
B5	Water outlet temp. 1	Water outlet temp. 2	Water inlet temp.		Outside set point	
B6			Water outlet temp. 1	Water outlet temp. 2		
B7	High pressure circuit 1	High pressure circuit 2	Cond. temp. circuit 1	Cond. temp. circuit 2	High pressure circuit 1	High pressure circuit 2
B8						

DIGITAL OUTPUTS

No.	pCO ² /pCO ³ MEDIUM		pCO ¹ MEDIUM		pCO ^c MEDIUM	
	Master (address 1)	Slaves (addresses 2/3/4)	Master (address 1)	Slaves (addresses 2/3/4)	Master (address 1)	Slaves (addresses 2/3/4)
NO1	Winding A comp. 1	Winding A comp. 2	Winding A comp. 1	Winding A comp. 2	Evap. pump 1	
NO2	Winding B comp. 1	Winding B comp. 2	Winding B comp. 1	Winding B comp. 2	Winding A comp. 1	Winding A comp. 2
NO3	Load step 1 comp. 1	Load step 1 comp. 2	Load step 1 comp. 1	Load step 1 comp. 2	Winding B comp. 1	Winding B comp. 2
NO 4	Load step 2 comp. 1	Load step 2 comp. 2	Load step 2 comp. 1	Load step 2 comp. 2	Liq. solenoid circuit 1	Liq. solenoid circuit 2
NO 5	Load step 3 comp. 1	Load step 3 comp. 2	Load step 3 comp. 1	Load step 3 comp. 2	4-way valve circuit 1	4-way valve circuit 2
NO 6	Liq. solenoid circuit 1	Liq. solenoid circuit 2	Liq. solenoid circuit 1	Liq. solenoid circuit 2	Load step 1 comp. 1	Load step 1 comp. 2
NO 7	Evap. pump 1	Evap. pump 2. / Disable fan coil	Evap. pump 1	Evap. pump 2. / Disable fan coil	Load step 2 comp. 1	Load step 2 comp. 2
NO 8	General alarm	General alarm	General alarm	General alarm	Load step 3 comp. 1	Load step 3 comp. 2
NO 9	Cond. fan 1 circ. 1	Cond. fan 1 circ. 2	Cond. fan 1 circ. 1	Cond. fan 1 circ. 2	Cond. fan 2 circ. 1	Cond. fan 2 circ. 2
NO10	Cond. fan 2 circ. 1	Cond. fan 2 circ. 2	Cond. fan 2 circ. 1	Cond. fan 2 circ. 2	Antifreeze heater 1	Antifreeze heater 2
NO11	4-way valve circuit 1	4-way valve circuit 2	4-way valve circuit 1	4-way valve circuit 2	General alarm	General alarm
NO12	Cond. fan 3 circ. 1	Cond. fan 3 circ. 2	Cond. fan 3 circ. 1	Cond. fan 3 circ. 2	Cond. fan 1 circ. 1	Cond. fan 1 circ. 2
NO13	Antifreeze heater 1	Antifreeze heater 2	Antifreeze heater 1	Antifreeze heater 2	Cond. fan 3 circ. 1	Cond. fan 3 circ. 2

ANALOGUE OUTPUTS

No.	pCO ² /pCO ³ MEDIUM		pCO ¹ MEDIUM		pCO ^c MEDIUM	
	Master (address 1)	Slaves (addresses 2/3/4)	Master (address 1)	Slaves (addresses 2/3/4)	Master (address 1)	Slaves (addresses 2/3/4)
Y1					Cond. fan inverter1	Cond. fan 2 inverter
Y2						
Y3	Cond. fan 1 inverter	Cond. fan 2 inverter	Cond. fan inverter1	Cond. fan 2 inverter		
Y4						

6.20 Chiller units with heat Pump and total heat recovery, configuration "19"

AIR/WATER units with maximum 4 semi-hermetic compressors (up to 3 load steps per comp.).

DIGITAL INPUTS

No.	pCO ² /pCO ³ MEDIUM		pCO ¹ MEDIUM		pCO ^c MEDIUM	
	Master (address 1)	Slaves (addresses 2/3/4)	Master (address 1)	Slaves (addresses 2/3/4)	Master (address 1)	Slaves (addresses 2/3/4)
ID 1	Serious alarm	Serious alarm (can be enabled)	Serious alarm	Serious alarm (can be enabled)	Serious alarm	Serious alarm (can be enabled)
ID 2	Evaporator flow switch	Evap. flow switch (can be enabled)	Evaporator flow switch	Evap. flow switch (can be enabled)	Evaporator flow switch	Evap. flow switch (can be enabled)
ID 3	Remote ON/OFF		Remote ON/OFF		Remote ON/OFF	
ID 4	Pump 1 thermal overload	Pump 2 thermal overload	Pump 1 thermal overload	Pump 2 thermal overload	Cooling/heating selection	
ID 5	Low pressure switch 1	Low pressure switch 2	Low pressure switch 1	Low pressure switch 2	Low press. switch 1	Low press. switch 2
ID 6	Oil differential 1	Oil differential 2	Oil differential 1	Oil differential 2	Oil differential 1	Oil differential 2
ID 7	Fan 1 thermal overload circuit 1	Fan 1 thermal overload circuit 2	Fan 1 thermal overload circuit 1	Fan 1 thermal overload circuit 2	Fan 1 thermal overload circuit 1	Fan 1 thermal overload circuit 2
ID 8						
ID 9						
ID 10					Pump thermal overload	
ID 11	Cooling/heating selection		Cooling/heating selection		High press. switch 1	High press. switch 2
ID 12					Comp. 1 thermal overload	Comp. 2 thermal overload
ID 13	High pressure switch 1	High pressure switch 2	High pressure switch 1	High pressure switch 2		
ID 14	Comp. 1 thermal overload	Comp. 2 thermal overload	Comp. 1 thermal overload	Comp. 2 thermal overload		

ANALOGUE INPUTS

No.	pCO ² /pCO ³ MEDIUM		pCO ¹ MEDIUM		pCO ^c MEDIUM	
	Master (address 1)	Slaves (addresses 2/3/4)	Master (address 1)	Slaves (addresses 2/3/4)	Master (address 1)	Slaves (addresses 2/3/4)
B1	Cond. temp. circuit 1	Cond. temp. circuit 2	Outside set point		Water inlet temp.	
B2	Boiler recovery inlet temp.		Boiler recovery outlet temp.		Water outlet temp. 1	Water outlet temp. 2
B3	Outside set point		High pressure circuit 1	High pressure circuit 2	Cond. temp. circuit 1	Cond. temp. circuit 2
B4	Water inlet temp.				Boiler recovery inlet temp.	
B5	Water outlet temp. 1	Water outlet temp. 2	Water inlet temp.		Outside set point	
B6	Boiler recovery outlet temp.		Water outlet temp. 1	Water outlet temp. 2	Boiler recovery outlet temp.	
B7	High pressure circuit 1	High pressure circuit 2	Cond. temp. circuit 1	Cond. temp. circuit 2	High pressure circuit 1	High pressure circuit 2
B8			Boiler recovery inlet temp.			

DIGITAL OUTPUTS

No.	pCO ² /pCO ³ MEDIUM		pCO ¹ MEDIUM		pCO ^c MEDIUM	
	Master (address 1)	Slaves (addresses 2/3/4)	Master (address 1)	Slaves (addresses 2/3/4)	Master (address 1)	Slaves (addresses 2/3/4)
NO1	Winding A comp. 1	Winding A comp. 2	Winding A comp. 1	Winding A comp. 2	Evap. pump 1	
NO2	Winding B comp. 1	Winding B comp. 2	Winding B comp. 1	Winding B comp. 2	Winding A comp. 1	Winding A comp. 2
NO3	Load step 1 comp. 1	Load step 1 comp. 2	Load step 1 comp. 1	Load step 1 comp. 2	Winding B comp. 1	Winding B comp. 2
NO 4	Load step 2 comp. 1	Load step 2 comp. 2	Load step 2 comp. 1	Load step 2 comp. 2	Liq. solenoid circuit 1	Liq. solenoid circuit 2
NO 5	Load step 3 comp. 1	Load step 3 comp. 2	Load step 3 comp. 1	Load step 3 comp. 2	Valve A	
NO 6	Liquid solenoid circuit 1	Liq. solenoid circuit 2	Liquid solenoid circuit 1	Liq. solenoid circuit 2	Load step 1 comp. 1	Load step 1 comp. 2
NO 7	Evap. pump 1	Evap. pump 2. / Disable fan coil	Evap. pump 1	Evap. pump 2. / Disable fan coil	Load step 2 comp. 1	Load step 2 comp. 2
NO 8	General alarm	General alarm	General alarm	General alarm	Load step 3 comp. 1	Load step 3 comp. 2
NO 9	Cond. fan 1 circ. 1	Cond. fan 1 circ. 2	Cond. fan 1 circ. 1	Cond. fan 1 circ. 2	Valve B	
NO10	Valve B		Valve B		Antifreeze heater 1	Antifreeze heater 2
NO11	Valve A		Valve A		General alarm	General alarm
NO12	Valve C		Valve C		Cond. fan 1 circ. 1	Cond. fan 1 circ. 2
NO13	Antifreeze heater 1	Antifreeze heater 2	Antifreeze heater 1	Antifreeze heater 2	Valve C	

ANALOGUE OUTPUTS

No.	pCO ² /pCO ³ MEDIUM		pCO ¹ MEDIUM		pCO ^c MEDIUM	
	Master (address 1)	Slaves (addresses 2/3/4)	Master (address 1)	Slaves (addresses 2/3/4)	Master (address 1)	Slaves (addresses 2/3/4)
Y1					Cond. fan inverter1	Cond. fan 2 inverter
Y2						
Y3	Cond. fan 1 inverter	Cond. fan 2 inverter	Cond. fan inverter1	Cond. fan 2 inverter		
Y4						

6.21 Condensing units, configuration "20"

AIR/AIR units with maximum 4 semi-hermetic compressors (up to 3 load steps per comp.).

DIGITAL INPUTS

No.	pCO ² /pCO ³ MEDIUM		pCO ¹ MEDIUM		pCO ^c MEDIUM	
	Master (address 1)	Slaves (addresses 2/3/4)	Master (address 1)	Slaves (addresses 2/3/4)	Master (address 1)	Slaves (addresses 2/3/4)
ID 1	Serious alarm	Serious alarm (can be enabled)	Serious alarm	Serious alarm (can be enabled)	Serious alarm	Serious alarm (can be enabled)
ID 2	Evaporator flow switch	Evap. flow switch (can be enabled)	Evaporator flow switch	Evap. flow switch (can be enabled)	Evaporator flow switch	Evap. flow switch (can be enabled)
ID 3	Remote ON/OFF		Remote ON/OFF		Remote ON/OFF	
ID 4	Main fan thermal overload		Main fan thermal overload		Main fan thermal overload	
ID 5	Low press. switch 1	Low press. switch 2	Low press. switch 1	Low press. switch 2	Low press. switch 1	Low press. switch 2
ID 6	Oil differential 1	Oil differential 2	Oil differential 1	Oil differential 2	Oil differential 1	Oil differential 2
ID 7	Fan 1 thermal overload circuit 1	Fan 1 thermal overload circuit 2	Fan 1 thermal overload circuit 1	Fan 1 thermal overload circuit 2	Fan 1 thermal overload circuit 1	Fan 1 thermal overload circuit 2
ID 8	Fan 2 thermal overload circuit 1	Fan 2 thermal overload circuit 2	Fan 2 thermal overload circuit 1	Fan 2 thermal overload circuit 2	Fan 2 thermal overload circuit 1	Fan 2 thermal overload circuit 2
ID 9	Fan 3 thermal overload circuit 1	Fan 3 thermal overload circuit 2	Fan 3 thermal overload circuit 1	Fan 3 thermal overload circuit 2	Fan 3 thermal overload circuit 1	Fan 3 thermal overload circuit 2
ID10						
ID11					High press. switch 1	High press. switch 2
ID12					Comp. 1 thermal overload	Comp. 2 thermal overload
ID13	High press. switch 1	High press. switch 2	High press. switch 1	High press. switch 2		
ID14	Comp. 1 thermal overload	Comp. 2 thermal overload	Comp. 1 thermal overload	Comp. 2 thermal overload		

ANALOGUE INPUTS

No.	pCO ² /pCO ³ MEDIUM		pCO ¹ MEDIUM		pCO ^c MEDIUM	
	Master (address 1)	Slaves (addresses 2/3/4)	Master (address 1)	Slaves (addresses 2/3/4)	Master (address 1)	Slaves (addresses 2/3/4)
B1	Cond. temp. circuit 1	Cond. temp. circuit 2	Remote comp. control			
B2					Air outlet temp. 1	Air outlet temp. 2
B3	Remote comp. control		High pressure circuit 1	High pressure circuit 2	Cond. temp. circuit 1	Cond. temp. circuit 2
B4						
B5	Air outlet temp. 1	Air outlet temp. 2			Remote comp. control	
B6			Air outlet temp. 1	Air outlet temp. 2		
B7	High pressure circuit 1	High pressure circuit 2	Cond. temp. circuit 1	Cond. temp. circuit 2	High pressure circuit 1	High pressure circuit 2
B8						

DIGITAL OUTPUTS

No.	pCO ² /pCO ³ MEDIUM		pCO ¹ MEDIUM		pCO ^c MEDIUM	
	Master (address 1)	Slaves (addresses 2/3/4)	Master (address 1)	Slaves (addresses 2/3/4)	Master (address 1)	Slaves (addresses 2/3/4)
NO1	Winding A comp. 1	Winding A comp. 2	Winding A comp. 1	Winding A comp. 2	Circulating fan	
NO2	Winding B comp. 1	Winding B comp. 2	Winding B comp. 1	Winding B comp. 2	Winding A comp. 1	Winding A comp. 2
NO3	Load step 1 comp. 1	Load step 1 comp. 2	Load step 1 comp. 1	Load step 1 comp. 2	Winding B comp. 1	Winding B comp. 2
NO 4	Load step 2 comp. 1	Load step 2 comp. 2	Load step 2 comp. 1	Load step 2 comp. 2	Liq. solenoid circuit 1	Liq. solenoid circuit 2
NO 5	Load step 3 comp. 1	Load step 3 comp. 2	Load step 3 comp. 1	Load step 3 comp. 2	Cond. fan 3 circ. 1	Cond. fan 3 circ. 2
NO 6	Liq. solenoid circuit 1	Liq. solenoid circuit 2	Liq. solenoid circuit 1	Liq. solenoid circuit 2	Load step 1 comp. 1	Load step 1 comp. 2
NO 7	Circulating fan		Circulating fan		Load step 2 comp. 1	Load step 2 comp. 2
NO 8	General alarm	General alarm	General alarm	General alarm	Load step 3 comp. 1	Load step 3 comp. 2
NO 9	Cond. fan 1 circ. 1	Cond. fan 1 circ. 2	Cond. fan 1 circ. 1	Cond. fan 1 circ. 2	Cond. fan 2 circ. 1	Cond. fan 2 circ. 2
NO10	Cond. fan 2 circ. 1	Cond. fan 2 circ. 2	Cond. fan 2 circ. 1	Cond. fan 2 circ. 2	Antifreeze heater 1	Antifreeze heater 2
NO11	Cond. fan 3 circ. 1	Cond. fan 3 circ. 2	Cond. fan 3 circ. 1	Cond. fan 3 circ. 2	General alarm	General alarm
NO12					Cond. fan 1 circ. 1	Cond. fan 1 circ. 2
NO13	Antifreeze heater 1	Antifreeze heater 2	Antifreeze heater 1	Antifreeze heater 2		

ANALOGUE OUTPUTS

No.	pCO ² /pCO ³ MEDIUM		pCO ¹ MEDIUM		pCO ^c MEDIUM	
	Master (address 1)	Slaves (addresses 2/3/4)	Master (address 1)	Slaves (addresses 2/3/4)	Master (address 1)	Slaves (addresses 2/3/4)
Y1					Cond. fan inverter1	Cond. fan 2 inverter
Y2						
Y3	Cond. fan inverter1	Cond. fan 2 inverter	Cond. fan 1 inverter	Cond. fan 2 inverter		
Y4						

6.22 Condensing units with heat pump, configuration "21"

AIR/AIR units with maximum 4 semi-hermetic compressors (up to 3 load steps per comp.).

DIGITAL INPUTS

No.	pCO ² /pCO ³ MEDIUM		pCO ¹ MEDIUM		pCO ^c MEDIUM	
	Master (address 1)	Slaves (addresses 2/3/4)	Master (address 1)	Slaves (addresses 2/3/4)	Master (address 1)	Slaves (addresses 2/3/4)
ID 1	Serious alarm	Serious alarm (can be enabled)	Serious alarm	Serious alarm (can be enabled)	Serious alarm	Serious alarm (can be enabled)
ID 2	Evaporator flow switch	Evap. flow switch (can be enabled)	Evaporator flow switch	Evap. flow switch (can be enabled)	Evaporator flow switch	Evap. flow switch (can be enabled)
ID 3	Remote ON/OFF		Remote ON/OFF		Remote ON/OFF	
ID 4					Cooling/heating selection	
ID 5	Low press. switch 1	Low press. switch 2	Low press. switch 1	Low press. switch 2	Low press. switch 1	Low press. switch 2
ID 6	Oil differential 1	Oil differential 2	Oil differential 1	Oil differential 2	Oil differential 1	Oil differential 2
ID 7	Fan thermal overload circuit 1	Fan thermal overload circuit 2	Fan thermal overload circuit 1	Fan thermal overload circuit 2	Fan thermal overload circuit 1	Fan thermal overload circuit 2
ID 8	Fan thermal overload circuit 1	Fan thermal overload circuit 2	Fan thermal overload circuit 1	Fan thermal overload circuit 2	Fan thermal overload circuit 1	Fan thermal overload circuit 2
ID 9	Fan thermal overload circuit 1	Fan thermal overload circuit 2	Fan thermal overload circuit 1	Fan thermal overload circuit 2	Fan thermal overload circuit 1	Fan thermal overload circuit 2
ID 10						
ID 11	Cooling/heating selection		Cooling/heating selection		High press. switch 1	High press. switch 2
ID 12					Comp. 1 thermal overload	Comp. 2 thermal overload
ID 13	High press. switch 1	High press. switch 2	High press. switch 1	High press. switch 2		
ID 14	Comp. 1 thermal overload	Comp. 2 thermal overload	Comp. 1 thermal overload	Comp. 2 thermal overload		

ANALOGUE INPUTS

No.	pCO ² /pCO ³ MEDIUM		pCO ¹ MEDIUM		pCO ^c MEDIUM	
	Master (address 1)	Slaves (addresses 2/3/4)	Master (address 1)	Slaves (addresses 2/3/4)	Master (address 1)	Slaves (addresses 2/3/4)
B1	Cond. temp. circuit 1	Cond. temp. circuit 2	Remote comp. control			
B2					Water outlet temp. 1	Water outlet temp. 2
B3	Remote comp. control		High pressure circuit 1	High pressure circuit 2	Cond. temp. circuit 1	Cond. temp. circuit 2
B4						
B5	Water outlet temp. 1	Water outlet temp. 2			Remote comp. control	
B6			Water outlet temp. 1	Water outlet temp. 2		
B7	High pressure circuit 1	High pressure circuit 2	Cond. temp. circuit 1	Cond. temp. circuit 2	High pressure circuit 1	High pressure circuit 2
B8						

DIGITAL OUTPUTS

No.	pCO ² /pCO ³ MEDIUM		pCO ¹ MEDIUM		pCO ^c MEDIUM	
	Master (address 1)	Slaves (addresses 2/3/4)	Master (address 1)	Slaves (addresses 2/3/4)	Master (address 1)	Slaves (addresses 2/3/4)
NO1	Winding A comp. 1	Winding A comp. 2	Winding A comp. 1	Winding A comp. 2	Circulating fan	
NO2	Winding B comp. 1	Winding B comp. 2	Winding B comp. 1	Winding B comp. 2	Winding A comp. 1	Winding A comp. 2
NO3	Load step 1 comp. 1	Load step 1 comp. 2	Load step 1 comp. 1	Load step 1 comp. 2	Winding B comp. 1	Winding B comp. 2
NO 4	Load step 2 comp. 1	Load step 2 comp. 2	Load step 2 comp. 1	Load step 2 comp. 2	Liq. solenoid circuit 1	Liq. solenoid circuit 2
NO 5	Load step 3 comp. 1	Load step 3 comp. 2	Load step 3 comp. 1	Load step 3 comp. 2	Cond. fan 3 circ. 1	Cond. fan 3 circ. 2
NO 6	Liq. solenoid circuit 1	Liq. solenoid circuit 2	Liq. solenoid circuit 1	Liq. solenoid circuit 2	Load step 1 comp. 1	Load step 1 comp. 2
NO 7	Circulating fan		Circulating fan		Load step 2 comp. 1	Load step 2 comp. 2
NO 8	General alarm	General alarm	General alarm	General alarm	Load step 3 comp. 1	Load step 3 comp. 2
NO 9	Cond. fan 1 circ. 1	Cond. fan 1 circ. 2	Cond. fan 1 circ. 1	Cond. fan 1 circ. 2	Cond. fan 2 circ. 1	Cond. fan 2 circ. 2
NO10	Cond. fan 2 circ. 1	Cond. fan 2 circ. 2	Cond. fan 2 circ. 1	Cond. fan 2 circ. 2	Antifreeze heater 1	Antifreeze heater 2
NO11	Cond. fan 3 circ. 1	Cond. fan 3 circ. 2	Cond. fan 3 circ. 1	Cond. fan 3 circ. 2	General alarm	General alarm
NO12	4-way valve	4-way valve	4-way valve	4-way valve	Cond. fan 1 circ. 1	Cond. fan 1 circ. 2
NO13	Antifreeze heater 1	Antifreeze heater 2	Antifreeze heater 1	Antifreeze heater 2	4-way valve	4-way valve

ANALOGUE OUTPUTS

No.	pCO ² /pCO ³ MEDIUM		pCO ¹ MEDIUM		pCO ^c MEDIUM	
	Master (address 1)	Slaves (addresses 2/3/4)	Master (address 1)	Slaves (addresses 2/3/4)	Master (address 1)	Slaves (addresses 2/3/4)
Y1					Cond. fan 1 inverter	Cond. fan 2 inverter
Y2						
Y3	Cond. fan 1 inverter	Cond. fan 2 inverter	Cond. fan 1 inverter	Cond. fan 2 inverter		
Y4						

6.23 Chiller-only units, configuration "22"

WATER / WATER units with maximum 4 semi-hermetic compressors (up to 3 load steps per comp.).

DIGITAL INPUTS

No.	pCO ² /pCO ³ MEDIUM		pCO ¹ MEDIUM		pCO ^c MEDIUM	
	Master (address 1)	Slaves (addresses 2/3/4)	Master (address 1)	Slaves (addresses 2/3/4)	Master (address 1)	Slaves (addresses 2/3/4)
ID 1	Serious alarm	Serious alarm (can be enabled)	Serious alarm	Serious alarm (can be enabled)	Serious alarm	Serious alarm (can be enabled)
ID 2	Evaporator flow switch	Evap. flow switch (can be enabled)	Evaporator flow switch	Evap. flow switch (can be enabled)	Evaporator flow switch	Evap. flow switch (can be enabled)
ID 3	Remote ON/OFF		Remote ON/OFF		Remote ON/OFF	
ID 4	Pump 1 thermal overload	Pump 2 thermal overload	Pump 1 thermal overload	Pump 2 thermal overload	Pump thermal overload	
ID 5	Low press. switch 1	Low press. switch 2	Low press. switch 1	Low press. switch 2	Low press. switch 1	Low press. switch 2
ID 6	Oil differential 1	Oil differential 2	Oil differential 1	Oil differential 2	Oil differential 1	Oil differential 2
ID 7	Condenser flow switch	Condenser flow switch (can be enabled)	Condenser flow switch	Condenser flow switch (can be enabled)	Condenser flow switch	Condenser flow switch (can be enabled)
ID 8						
ID 9						
ID10	Cond. pump thermal overload		Cond. pump thermal overload		Cond. pump thermal overload	
ID11					High press. switch 1	High press. switch 2
ID12					Compressor 1 thermal overload	Compressor 2 thermal overload
ID13	High press. switch 1	High press. switch 2	High press. switch 1	High press. switch 2		
ID14	Compressor 1 thermal overload	Compressor 2 thermal overload	Compressor 1 thermal overload	Compressor 2 thermal overload		

ANALOGUE INPUTS

No.	pCO ² /pCO ³ MEDIUM		pCO ¹ MEDIUM		pCO ^c MEDIUM	
	Master (address 1)	Slaves (addresses 2/3/4)	Master (address 1)	Slaves (addresses 2/3/4)	Master (address 1)	Slaves (addresses 2/3/4)
B1	Water outlet temp. 1	Water outlet temp. 2	Outside set point		Water inlet temp.	
B2	Cond. inlet temp. 1	Cond. inlet temp. 2			Water outlet temp. 1	Water outlet temp. 2
B3	Outside set point		High pressure circuit 1	High pressure circuit 2	Cond. inlet temp. 1	Cond. inlet temp. 2
B4	Water inlet temp.				Cond. outlet temp. 1	Cond. outlet temp. 2
B5	Water outlet temp. 1	Water outlet temp. 2	Water inlet temp.		Outside set point	
B6			Water outlet temp. 1	Water outlet temp. 2		
B7	High pressure circuit 1	High pressure circuit 2	Cond. inlet temp. 1	Cond. inlet temp. 2	High pressure circuit 1	High pressure circuit 2
B8			Cond. outlet temp. 1	Cond. outlet temp. 2		

DIGITAL OUTPUTS

No.	pCO ² /pCO ³ MEDIUM		pCO ¹ MEDIUM		pCO ^c MEDIUM	
	Master (address 1)	Slaves (addresses 2/3/4)	Master (address 1)	Slaves (addresses 2/3/4)	Master (address 1)	Slaves (addresses 2/3/4)
NO1	Winding A comp. 1	Winding A comp. 2	Winding A comp. 1	Winding A comp. 2	Evap. pump 1 Evapor.	
NO2	Winding B comp. 1	Winding B comp. 2	Winding B comp. 1	Winding B comp. 2	Winding A comp. 1	Winding A comp. 2
NO3	Load step 1 comp. 1	Load step 1 comp. 2	Load step 1 comp. 1	Load step 1 comp. 2	Winding B comp. 1	Winding B comp. 2
NO 4	Load step 2 comp. 1	Load step 2 comp. 2	Load step 2 comp. 1	Load step 2 comp. 2	Liq. solenoid circuit 1	Liq. solenoid circuit 2
NO 5	Load step 3 comp. 1	Load step 3 comp. 2	Load step 3 comp. 1	Load step 3 comp. 2		
NO 6	Liq. solenoid circuit 1	Liq. solenoid circuit 2	Liq. solenoid circuit 1	Liq. solenoid circuit 2	Load step 1 comp. 1	Load step 1 comp. 2
NO 7	Evap. pump 1	Evap. pump 2. / Disable fan coil	Evap. pump 1	Evap. pump 2. / Disable fan coil	Load step 2 comp. 1	Load step 2 comp. 2
NO 8	General alarm	General alarm	General alarm	General alarm	Load step 3 comp. 1	Load step 3 comp. 2
NO 9					Condenser pump	
NO10	Condenser pump		Condenser pump		Antifreeze heater 1	Antifreeze heater 2
NO11					General alarm	General alarm
NO12						
NO13	Antifreeze heater 1	Antifreeze heater 2	Antifreeze heater 1	Antifreeze heater 2		

ANALOGUE OUTPUTS

No.	pCO ² /pCO ³ MEDIUM		pCO ¹ MEDIUM		pCO ^c MEDIUM	
	Master (address 1)	Slaves (addresses 2/3/4)	Master (address 1)	Slaves (addresses 2/3/4)	Master (address 1)	Slaves (addresses 2/3/4)
Y1						
Y2						
Y3						
Y4						

6.24 Cooling/heating units with reversal on the water circuit, configuration "23"

WATER / WATER units with maximum 4 semi-hermetic compressors (up to 3 load steps per comp.).

DIGITAL INPUTS

No.	pCO ² /pCO ³ MEDIUM		pCO ¹ MEDIUM		pCO ^c MEDIUM	
	Master (address 1)	Slaves (addresses 2/3/4)	Master (address 1)	Slaves (addresses 2/3/4)	Master (address 1)	Slaves (addresses 2/3/4)
ID 1	Serious alarm	Serious alarm (can be enabled)	Serious alarm	Serious alarm (can be enabled)	Serious alarm	Serious alarm (can be enabled)
ID 2	Evaporator flow switch	Evap. flow switch (can be enabled)	Evaporator flow switch	Evap. flow switch (can be enabled)	Evaporator flow switch	Evap. flow switch (can be enabled)
ID 3	Remote ON/OFF		Remote ON/OFF		Remote ON/OFF	
ID 4	Evaporator pump 1 thermal overload	Evaporator pump 2 thermal overload	Evaporator pump 1 thermal overload	Evaporator pump 2 thermal overload	Cooling/heating selection	
ID 5	Low press. switch 1	Low press. switch 2	Low press. switch 1	Low press. switch 2	Low press. switch 1	Low press. switch 2
ID 6	Oil differential 1	Oil differential 2	Oil differential 1	Oil differential 2	Oil differential 1	Oil differential 2
ID 7	Condenser flow switch	Condenser flow switch (can be enabled)	Condenser flow switch	Condenser flow switch (can be enabled)	Condenser flow switch	Condenser flow switch (can be enabled)
ID 8						
ID 9					Evaporator pump thermal overload	
ID10	Cond. pump thermal overload		Cond. pump thermal overload		Cond. pump thermal overload	
ID11	Cooling/heating selection		Cooling/heating selection		High press. switch 1	High press. switch 2
ID12					Compressor 1 thermal overload	Compressor 2 thermal overload
ID13	High press. switch 1	High press. switch 2	High press. switch 1	High press. switch 2		
ID14	Compressor 1 thermal overload	Compressor 2 thermal overload	Compressor 1 thermal overload	Compressor 2 thermal overload		

ANALOGUE INPUTS

No.	pCO ² /pCO ³ MEDIUM		pCO ¹ MEDIUM		pCO ^c MEDIUM	
	Master (address 1)	Slaves (addresses 2/3/4)	Master (address 1)	Slaves (addresses 2/3/4)	Master (address 1)	Slaves (addresses 2/3/4)
B1	Cond. inlet temp. 1	Cond. inlet temp. 2	Outside set point		Water inlet temp.	
B2	Cond. outlet temp. 1	Cond. outlet temp. 2			Water outlet temp. 1	Water outlet temp. 2
B3	Outside set point		High pressure circuit 1	High pressure circuit 2	Cond. inlet temp. 1	Cond. inlet temp. 2
B4	Water inlet temp.				Cond. outlet temp. 1	Cond. outlet temp. 2
B5	Water outlet temp. 1	Water outlet temp. 2	Water inlet temp.		Outside set point	
B6			Water outlet temp. 1	Water outlet temp. 2		
B7	High pressure circuit 1	High pressure circuit 2	Cond. inlet temp. 1	Cond. inlet temp. 2	High pressure circuit 1	High pressure circuit 2
B8			Cond. outlet temp. 1	Cond. outlet temp. 2		

DIGITAL OUTPUTS

No.	pCO ² /pCO ³ MEDIUM		pCO ¹ MEDIUM		pCO ^c MEDIUM	
	Master (address 1)	Slaves (addresses 2/3/4)	Master (address 1)	Slaves (addresses 2/3/4)	Master (address 1)	Slaves (addresses 2/3/4)
NO1	Winding A comp. 1	Winding A comp. 2	Winding A comp. 1	Winding A comp. 2	Evap. pump 1	
NO2	Winding B comp. 2	Winding B comp. 2	Winding B comp. 2	Winding B comp. 2	Winding A comp. 1	Winding A comp. 2
NO3	Load step 1 comp. 1	Load step 1 comp. 2	Load step 1 comp. 1	Load step 1 comp. 2	Winding B comp. 1	Winding B comp. 2
NO 4	Load step 2 comp. 1	Load step 2 comp. 2	Load step 2 comp. 1	Load step 2 comp. 2	Liq. solenoid circuit 1	Liq. solenoid circuit 2
NO 5	Load step 3 comp. 1	Load step 3 comp. 2	Load step 3 comp. 1	Load step 3 comp. 2	Water circ. reversing valve	
NO 6	Liquid solenoid circ. 1	Liquid solenoid circ. 2	Liquid solenoid circ. 1	Liquid solenoid circ. 2	Load step 1 comp. 1	Load step 1 comp. 2
NO 7	Evap. pump 1	Evap. pump 2. / Disable fan coil	Evap. pump 1	Evap. pump 2. / Disable fan coil	Load step 2 comp. 1	Load step 2 comp. 2
NO 8	General alarm	General alarm	General alarm	General alarm	Load step 3 comp. 1	Load step 3 comp. 2
NO 9					Condenser pump	
NO10	Condenser pump		Condenser pump		Antifreeze heater 1	Antifreeze heater 2
NO11	Water circ. reversing valve		Water circ. reversing valve		General alarm	General alarm
NO12						
NO13	Antifreeze heater 1	Antifreeze heater 2	Antifreeze heater 1	Antifreeze heater 2		

ANALOGUE OUTPUTS

No.	pCO ² /pCO ³ MEDIUM		pCO ¹ MEDIUM		pCO ^c MEDIUM	
	Master (address 1)	Slaves (addresses 2/3/4)	Master (address 1)	Slaves (addresses 2/3/4)	Master (address 1)	Slaves (addresses 2/3/4)
Y1						
Y2						
Y3						
Y4						

6.25 Air/water units with maximum 4 hermetic compressors for PCO^{XS}

Chiller-only - configuration "0".

DIGITAL INPUTS

No.	pCO ^{XS}	
	Master (address 1)	Slaves (addresses 2/3/4)
ID 1	High press. switch 1	High press. switch 2
ID 2	Evaporator flow switch	Evaporator flow switch (can be enabled)
ID 3	Remote ON/OFF	
ID 4	Pump thermal overload	Pump 2 thermal overload
ID 5	Low press. switch 1	Low press. switch 2
ID 6	Comp. 1 thermal overload	Comp. 2 thermal overload

ANALOGUE INPUTS

No.	pCO ^{XS}	
	Master (address 1)	Slaves (addresses 2/3/4)
B1	Outside set point	
B2	High pressure circuit 1	High pressure circuit 2
B3	Water inlet temp.	
B4	Water outlet temp. 1	Water outlet temp. 2

DIGITAL OUTPUTS

No.	pCO ^{XS}	
	Master (address 1)	Slaves (addresses 2/3/4)
NO1	Evap. pump 1	Evap. pump 2.
NO2	Compressor 1	Compressor 2
NO3	Antifreeze heater 1	Antifreeze heater 2
NO 4	Liq. solenoid circuit 1	Liq. solenoid circuit 2
NO 5	General alarm	

ANALOGUE OUTPUTS

No.	pCO ^{XS}	
	Master (address 1)	Slaves (addresses 2/3/4)
Y1	Cond. fan 1 inverter	Cond. fan 2 inverter
Y2		
Y3	Cond. fan 1 speed control	Cond. fan 2 speed control

7. List of parameters and default values

This table contains the list of all the parameters that appear on the screens, with the corresponding description.

Parameter: string that appears on the screen;

Ref.: reference code for the screen in the application, index of the screen;

Description: synthetic description of the parameter;

M/S: parameter visible only on the Master unit, only on the Slave unit or on both

Range: range of values allowed for the parameter;

Default: default value of the parameter

UOM: unit of measure for the value in question;

User value: column available for comments by the user.

Important: not all the screens listed below are shown by scrolling the cursor on the display; when enabling a specific type of configuration, certain screens associated with such configuration will be displayed that previously were not visible. The display therefore depends on the configuration!

Parameter	Ref.	Description	M/S	Range	Default	UOM	User value
MAIN SCREEN		15-button terminal MENU button	PGD0 6 button or built-in terminal ESC button				
12:30 15/11/06	M0	Current date and time	M/S				
Inlet Water Ext.Control Outlet Water	M0	Main control parameters	M/S				
U:1	M0	pLAN address of the board	M/S				
UNIT ON/ OFF BY ALARM/ OFF BY SUPERV./OFF BY TIME Z./ OFF BY DIG.IN./OFF BY KEYB./MANUAL/OFF BY SLAVE	M0	Unit status	M/S				
Summer mode/ Winter mode	M1	Operating mode	M/S				
Cooling	M1	Cooling operation active	M/S				
Heating	M1	Heating operation active	M/S				
Frecool / HPPrev circ 1-2 / Recover / User / Rec+User / Defrost / Rec+Heat / User+Heat	M1	Unit status	M/S				
Defrost circ 1-2 / Pumpdown	M1	Status of the circuits	M/S				
Active steps 01/02	M1	Active temperature control steps	M/S				
MAINTENANCE		15-button terminal MAINTENANCE button	pGD0 6 button or built-in terminal PRG button and MAINTENANCE in the menu				
Codice: FLASTDMMCE	A0	Software code	M/S				
Ver. 1.0 19/03/2004	A0	Software version and date	M/S				
Bios:x.xx xx/xx/xx	A1	Version and date of the bios installed	M/S				
Boot:x.xx xx/xx/xx	A1	Version and date of the boot installed	M/S				
Manual c.:+030221250	A1	Manual code	M/S				
Ver. x.x xx/xx/xx	A1	Version and date of the manual	M/S				
Language used: ENGLISH	A2	Current language of the interface	M/S				
Main pump 1 / Main fan	A3	Pump 1 operating hours	M			hours	
Main pump 2	A3	Pump 2 operating hours	M			hours	
Hour meter Compressor 1	A4	Compressor 1 operating hours	M			hours	
Hour meter Compressor 2	A4	Compressor 2 operating hours	M			hours	
Hour meter Compressor 3	A5	Compressor 3 operating hours	S			hours	
Hour meter Compressor 4	A5	Compressor 4 operating hours	S			hours	
History alarm	A6	See Chapter 23	M/S				
State:	A7	Current status of the modem	M				
Field:	A7	Percentage reception of the GSM modem	M			%	
Insert maintenace password	A8	Enter password to access to the protected screens in the maintenance branch	M/S	0 to 9999	1234	hours	
Main pump/fan hour meter Threshold	Aa	Alarm 040 activation threshold "evaporator fan/pump maintenance alarm"	M/S	0 to 999	10	hours	
Req.reset	Aa	Reset pump/fan operating hours	M/S	0 to 1	0		
Compressor 1 hour meter	Ab	Alarm 041 activation threshold "Comp. 1 maintenance alarm"	M	0 to 999	10	hours	
Req.reset	Ab	Reset compressor 1 operating hours	M	0 to 1	0		
Compressor 2 hour meter	Ac	Alarm 042 activation threshold "Comp. 2 maintenance alarm"	M	0 to 999	10	hours	
Req.reset	Ac	Reset compressor 2 operating hours	M	0 to 1	0		
Compressor 3 hour meter	Ad	Alarm 043 activation threshold "Comp. 3 maintenance alarm"	S	0 to 999	10	hours	
Req.reset	Ad	Reset compressor 3 operating hours	S	0 to 1	0		
Compressor 4 hour meter	Ae	Alarm 044 activation threshold "Comp. 4 maintenance alarm"	S	0 to 999	10	hours	
Req.reset	Ae	Reset compressor 4 operating hours	S	0 to 1	0		
Inputs probes B1..B4	Af	Calibration of probes B1 to B4	M/S	-9.9T9.9	0	°C	
Inputs probes B5..B8	Ag	Calibration of probes B5 to B8	M/S	-9.9T9.9	0	°C	
Enable compressors C1..C8	Ah	Enable compressors C1 to C8 (if present)	M	0 to 1	1		
Erase historical memory board	Ai	Delete the log memory from application.	M/S	0 to 1	0		
Manual mng. D:1 EEV Position	Aj	Valve control mode for Driver 1	M/S	AUTO/MAN	AUTO		
Steps Opening	Aj	Current position of driver 1	M/S	0 to 999	0	step	
Position	Aj	Current position of EEV	M/S			step	
Manual mng. D:2 EEV Position	Ak	Valve control mode for Driver 2	M/S	AUTO/MAN	AUTO		
Steps Opening	Ak	Number of steps for manual valve opening Driver2	M/S	0 to 999	0	step	
Position	Ak	Current position of driver 2	M/S			step	
Manual mng. D:3 EEV Position	Al	Valve control mode for Driver 3	M/S	AUTO/MAN	AUTO		
Steps Opening	Al	Number of steps for manual valve opening Driver3	M/S	0 to 999	0	step	
Position	Al	Current position of driver 3	M/S			step	
Manual mng. D:4 EEV Position	Am	Valve control mode for Driver 4	M/S	AUTO/MAN	AUTO		
Steps Opening	Am	Number of steps for manual valve opening Driver4	M/S	0 to 999	0	step	
Position	Am	Current position of driver 4	M/S			step	
Driver 1 status	An	Current status of driver 1	M/S				
Go ahead?	An	Reset alarm condition on driver 1	M/S	Y/N	N		

Parameter	Ref.	Description	M/S	Range	Default	UOM	User value
Driver 2 status	Ao	Current status of driver 2	M/S				
Go ahead?	Ao	Reset alarm condition on driver 2	M/S	Y/N	N		
Driver 3 status	Ap	Current status of driver 3	M/S				
Go ahead?	Ap	Reset alarm condition on driver 3	M/S	Y/N	N		
Driver 4 status	Aq	Current status of driver 4	M/S				
Go ahead?	Aq	Reset alarm condition on driver 4	M/S	Y/N	N		
Send sms test	Ar	Functional test of the send SMS procedure	M/S	Y/N	N		
New password maintainance	As	Enter new Maintenance password	M	0 to 9999	1234		
CLOCK		15-button terminal CLOCK button	PGD0 6 button or built-in terminal PRG button and CLOCK in the menu				
Time	K1	Set current hour	M/S	0 to 23		hours	
		Set current minute	M/S	0 to 59		minutes	
Date:	K1	Set current day	M/S	1 to 31			
		Set current month	M/S	1 to 12			
		Set current year	M/S	0 to 99			
Insert clock password	K2	Enter Clock password	M/S	0 to 9999			
Timezone On-off unit	K3	Enable the ON/OFF time bands	M/S	Y/N			
Temp.setpoint	K3	Enable the set point time bands	M/S	Y/N			
On-off unit F1-1 F1-2	K4	Start and end hours and minutes of time bands F1-1 and F1-2	M/S	0 to 23 0 to 59		Hours minutes	
On-off unit F2	K5	Start and end hours and minutes of time band F2	M/S	0 to 23 0 to 59		Hours minutes	
On-off unit Mon:....Sun:	K6	Select ON/OFF time bands (F1,F2,F3,F4) for each day	M/S	F1,F2,F3,F4			
set point temp. Timezone1 start	K7	Start and end hours and minutes for temperature band 1	M/S	0 to 23 0 to 59		Hours minutes	
Summer	K7	Cooling temperature set point band 1	M/S	See P1		°C	
Winter	K7	Heating temperature set point band 1	M/S	See P1		°C	
set point temp. Timezone2 start	K8	Start and end hours and minutes for temperature band 2	M/S	0 to 23 0 to 59		Hours minutes	
Summer	K8	Cooling temperature set point band 2	M/S	See P1		°C	
Winter	K8	Heating temperature set point band 2	M/S	See P1		°C	
set point temp. Timezone3 start	K7	Start and end hours and minutes for temperature band 3	M/S	0 to 23 0 to 59		Hours minutes	
Summer	K7	Cooling temperature set point band 3	M/S	See P1		°C	
Winter	K7	Heating temperature set point band 3	M/S	See P1		°C	
set point temp. Timezone4 start	K8	Start and end hours and minutes for temperature band 4	M/S	0 to 23 0 to 59		Hours minutes	
Summer	K8	Cooling temperature set point band 4	M/S	See P1		°C	
Winter	K8	Heating temperature set point band 4	M/S	See P1		°C	
New password clock:	Ka	Enter new clock password	M/S				
SET POINT		15-button terminal SET POINT button	PGD0 6 button or built-in terminal PRG button and SET POINT in the menu				
Actual setpoint	S0	Current set point	M/S			°C	
Summer setpoint	S1	Cooling set point	M/S	See P1	12.0	°C	
Winter setpoint	S1	Heating set point	M/S	See P1		°C	
RECOVER Priority	S2	Select utility with higher priority	M/S	EVAPORATOR RECOVERY			
set point	S2	Recovery set point	M/S	-99.9T99.9	45.0	°C	
Diff.	S2	Recovery differential	M/S	0T99.9	3.0	°C	
Freecooling min threshold	S3	Start freecooling control threshold	M	-99.9T99.9		°C	
Freecool full load threshold	S3	Threshold for freecooling operation at maximum capacity	M	-99.9T99.9		°C	
Change-Over setpoint	S4	Set point selection for automatic changeover	M	P2/P3	20.0	°C	
USER		15-button terminal PROG button	PGD0 6 button or built-in terminal PRG button and USER in the menu				
Insert user password	P0	Enter password to access the programming branch	M/S		1234		
TEMPERATURE CONTROL →							
Regulation temperature band	P1	Temperature control band	M	0T99.9	3.0	°C	
Summer temp. setpoint limits Low	P2	Lower limit of the cooling set point	M	-99.9T99.9	7.0	°C	
High	P2	Upper limit of the cooling set point	M	-99.9T99.9	17.0	°C	
Winter temperat. setpoint limits Low	P3	Lower limit of the heating set point	M	-99.9T99.9	40.0	°C	
High	P3	Upper limit of the heating set point	M	-99.9T99.9	50.0	°C	
Type regulation temperature	P4	Type of temperature control	M	INLET/OUTLET	INLET		
Inlet regulation input Type	P5	Type of temperature control	M	PROP/P+I	PROP		
Integration t.	P5	Integral time for P+I control	M	0 to 9999	600	s	
Outlet regulation Rec.max time	P6	Maximum time to increase the request	M	0 to 9999	20	s	
Rec.min time	P6	Minimum time to increase the request	M	0 to 9999	20	s	
Outlet regulation Max time OFF	P7	Maximum time to decrease the request	M	0 to 9999	10	s	
Max time ON	P7	Minimum time to decrease the request	M	0 to 9999	10	s	
Delta temperature in which change the time	P8	Differential within which the increase and decrease times vary	M	-99.9T99.9	2.0	°C	
Summer temp. setpoint limits Low	P9	Force cooling shutdown	M	-99.9T99.9	5.0	°C	
Winter o Winter/Rec.	P9	Force heating shutdown	M	-99.9T99.9	47.0	°C	
Fancoils enable summer set	Pa	Cooling set point to enable fan coils	M	-99.9T99.9	0	°C	
winter set	Pa	Heating set point to enable fan coils	M	-99.9T99.9	0	°C	
Diff.	Pa	Enable fan coil set point differential	M	0T99.9	0	°C	
External setpoint Enable	Pb	Enable outside set point	M	Y/N	N		
Min	Pb	Minimum outside set point limit	M	-99.9T99.9	0	°C	
Max	Pb	Maximum outside set point limit	M	-99.9T99.9	50.0	°C	

Parameter	Ref.	Description	M/S	Range	Default	UOM	User value
Compensat.temp. setpoint enable	Pc	Enable set point compensation	M	Y/N	N		
Compensation max	Pc	Maximum set point compensation	M	-99.9T99.9	5.0	°C	
Summer compens. Start temp.	Pd	Start temperature for set point compensation in cooling	M	-99.9T99.9	25.0	°C	
End temp.	Pd	End temperature for set point compensation in cooling	M	-99.9T99.9	35.0	°C	
Winter compens. Start temp.	Pe	Start temperature for set point compensation in heating	M	-99.9T99.9	0.0	°C	
End temp.	Pe	End temperature for set point compensation in heating	M	-99.9T99.9	10.0	°C	
Unit Change-Over management	Pf	Select unit changeover mode	M	MANUAL AUTOMATIC	MANUAL		
Change-Over reg.neutral zone	Pg	Dead zone setting for automatic changeover	M	0 to 99.9	2.0	°C	
FREECOOLING →							
Reg.type	X1	Type of freecooling control	M	PROP/P+I	P+I		
Integration t.	X1	Integral time for P+I control	M	0 to 9999	150	s	
Setp. offset	X1	Freecooling control set point offset	M	0T99.9	5.0	°C	
Delta min.	X2	Minimum freecooling delta	M	0T99.9	5.0	°C	
Delta max.	X2	Maximum freecooling delta	M	0T99.9	10.0	°C	
Diff.	X3	Freecooling band	M	20T99.9	4.0	°C	
Comps delay	X3	Compressor start delay after freecooling	M	0 to 500	5	minutes	
Max open threshold valve	X4	Max. valve opening threshold for freecooling valve	M	25 to 100	50	%	
Min open threshold inverter	X5	Minimum condens. inverter start threshold.	M	0 to 75	50	%	
DEFROST →							
Defrost config. Probe	Q0	Select defrost probe	M/S	TEMPERATURE PRESSURE PRESSURE SWITCHES	TEMPERATU RE		
Global	Q0	Select the type of defrost for all the boards	M/S	SIMULTANEOUS SEPARATE INDEPENDENT	SIMULT.		
Local	Q0	Type of local defrost for the individual board, only if the global defrost is configured as independent.	M/S	SIMULTANEOUS SEPARATE	SIMULT.		
Start	Q1	Start defrost temperature/pressure set point	M/S	-99.9 to 99.9	2.0	°C/bar	
Stop	Q1	End defrost temperature/pressure set point	M/S	-99.9 to 99.9	12.0	°C/bar	
Delay time	Q2	Defrost request delay	M/S	1 to 32000	1800	s	
Maximum time	Q2	Maximum defrost duration	M/S	0 to 32000	300	s	
Compressors force off when defrost begins/ends for	Q3	Forced compressor shutdown at start and end defrost	M/S	0 to 999	60	s	
Reversing cycle delay	Q4	Valve reversing delay from start of defrost status	M/S	0 to 999	10	s	
VARIOUS PARAMETERS →							
Min.time between main pump/ fan and compressors start	R0	Minimum time between start of pump/fan and compressors	M	0 to 999	5	s	
Delay off switching the main pump/fan off start	R1	Pump/fan stop delay	M	0 to 999	5	s	
Hours number pumps rotation	R2	Number of hours for pump rotation (0= rotation by starts)	M	0 to 32767	0	h	
Digital input remote On/Off	R3	Enable ON/OFF from digital input	M	0 to 1	0		
Digital input remote Sum/Win	R3	Enable cooling/heating from digital input	M	0 to 1	0		
Supervisory remote On/Off	R4	Enable ON/OFF from supervisor	M	0 to 1	0		
Supervisory remote Sum/Win	R4	Enable heating/cooling selection from supervisor	M	0 to 1	0		
Supervisory protocol type	R5	Select type of supervisor protocol	M	CAREL MODBUS LONWORKS Rs232 MODEM ANALOGUE. MODEM GSM WINLOAD	CAREL		
Supervisory Communication speed:	R6	Select communication speed	M/S	1200, 2400, 4800, 9600, 19200	19200	bps	
Identificat.No.	R6	Identification number of the board in the supervision network	M/S	0 to 200	1		
Max.phone n.:	R7	Maximum number of items present in the address book	M/S	1 to 4	1		
Phone book number:	R7	Number of the item extracted from the address book	M/S	0 to 5	0		
Modem password	R7	Password of the modem required to receive data	M/S	0 to 9999	0		
Send Sms test	R8	Text displayed in the SMS sent	M/S				
Enable language mask at startup	R9	Enable the screen for selecting the language on application power-up	M/S	0 to 1	1		
New password user	Ra	Enter the new user password	M/S	0 to 9999	1234		
Main pump Burst	Rb	Enable burst mode for main pump	M	Y/N	N		
Burst OFF time	Rb	Main pump OFF time in burst mode	M	0 to 999	60	S	
Burst ON time	Rb	Main pump ON time in burst mode	M	0 to 999	60	S	
MANUFACTURER				PGD0 6 button or built-in terminal			
PROG + MENU buttons				PRG button and MANUFACTURER in the menu			
Insert manufactory password	Z0	Enter password to access the manufacturer branch	M/S	0 to 9999	1234		
CONFIGURATION →							
Unit config.	C0	Define the type of unit	M	0 to 23	16		
Probes enable B1..B3	C1	Enable probes from B1 to B3	M/S	N/Y	N/N/N		
Probes enable B4..B6	C2	Enable probes from B4 to B6	M/S	N/Y	Y/N/N		
Probes enable B7..B8	C3	Enable probes from B7 to B8	M/S	N/Y	N/N		
Local comp.number	C4	Number of compressors configured for the board	M/S	1 to 4	1		
Total comp.number	C4	Total number of compressors in the installation	M	0 to 8	1		
Unloads per comp.	C4	Number of load steps per compressor	M	0 to 1 unit s CpCp 0 to 3 units CCpp	3		
Number driver for circuit	C5	Number of drivers per circuit	M/S	0 to 2	0		
Bi flow valve present	C5	Enable management of bi-directional valves	M/S	N/Y	N		
Board clock Enable	C6	Enable the functions of the clock board	M/S	N/Y	N		
Enable control fancoils	C7	Enable the fan coil management functions	M	N/Y	N		
Number of evaporator pumps	C7	Number of evaporator pumps	M	0 to 2	1		
Evap./Condenser flow alarm and Serious alarm Enable	C8	Enable flow switch alarm and serious alarm on the Slave units	S	N/Y	S		

Parameter	Ref.	Description	M/S	Range	Default	UOM	User value
Type input analog B1	C9	Configuration of the type of probe connected to analogue input B1	M/S	NTC, PT1000, 0 to 1 V, 0 to 10 V, 0 to 20 mA, 4 to 20 mA, 0 to 5 V	NTC / 4 to 20 mA		
Type input analog B2	Ca	Configuration of the type of probe connected to analogue input B2	M/S	NTC, PT1000, 0 to 1 V, 0 to 10 V, 0 to 20 mA, 4 to 20 mA, 0 to 5 V	NTC / 4 to 20 mA		
Type input analog B3	Cb	Configuration of the type of probe connected to analogue input B3	M/S	NTC, PT1000, 0 to 1 V, 0 to 10 V, 0 to 20 mA, 4 to 20 mA, 0 to 5 V	NTC / 4 to 20 mA		
Type input analog B4	Cc	Configuration of the type of probe connected to analogue input B4	M/S	NTC, PT1000, 0 to 1 V, 0 to 10 V, 0 to 20 mA, 4 to 20 mA, 0 to 5 V	NTC / 4 to 20 mA		
Type input analog B5	Cd	Configuration of the type of probe connected to analogue input B5	M/S	NTC, PT1000, 0 to 1 V, 0 to 10 V, 0 to 20 mA, 4 to 20 mA, 0 to 5 V	NTC / 4 to 20 mA		
Type input analog B6	Ce	Configuration of the type of probe connected to analogue input B6	M/S	NTC, PT1000, 0 to 1 V, 0 to 10 V, 0 to 20 mA, 4 to 20 mA, 0 to 5 V	NTC / 4 to 20 mA		
Type input analog B7	Cf	Configuration of the type of probe connected to analogue input B7	M/S	NTC, PT1000, 0 to 1 V, 0 to 10 V, 0 to 20 mA, 4 to 20 mA, 0 to 5 V	NTC / 4 to 20 mA		
Type input analog B8	Cg	Configuration of the type of probe connected to analogue input B8	M/S	NTC, PT1000, 0 to 1 V, 0 to 10 V, 0 to 20 mA, 4 to 20 mA, 0 to 5 V	NTC / 4 to 20 mA		
Config. probe B1 Min value	Ch	Minimum value of probe B1	M/S	-300 to 1500	0	°C / % / bar	
Max value	Ch	Maximum value of probe B1	M/S	0 to 1500	0	°C / % / bar	
Config. probe B2 Min value	Ci	Minimum value of probe B2	M/S	-300 to 1500	0	°C / % / bar	
Max value	Ci	Maximum value of probe B2	M/S	0 to 1500	0	°C / % / bar	
Config. probe B3 Min value	Cj	Minimum value of probe B3	M/S	-300 to 1500	0	°C / % / bar	
Max value	Cj	Maximum value of probe B3	M/S	0 to 1500	0	°C / % / bar	
Config. probe B4 Min value	Ck	Minimum value of probe B4	M/S	-300 to 1500	0	°C / % / bar	
Max value	Ck	Maximum value of probe B4	M/S	0 to 1500	0	°C / % / bar	
Config. probe B5 Min value	Cl	Minimum value of probe B5	M/S	-300 to 1500	0	°C / % / bar	
Max value	Cl	Maximum value of probe B5	M/S	0 to 1500	0	°C / % / bar	
Config. probe B6 Min value	Cm	Minimum value of probe B6	M/S	-300 to 1500	0	°C / % / bar	
Max value	Cm	Maximum value of probe B6	M/S	0 to 1500	0	°C / % / bar	
Config. probe B7 Min value	Cn	Minimum value of probe B7	M/S	-300 to 1500	0	°C / % / bar	
Max value	Cn	Maximum value of probe B7	M/S	0 to 1500	0	°C / % / bar	
Config. probe B8 Min value	Co	Minimum value of probe B8	M/S	-300 to 1500	0	°C / % / bar	
Max value	Co	Maximum value of probe B8	M/S	0 to 1500	0	°C / % / bar	
Condensation enable	Cp	Enable and configure the type of condenser control	M/S	NONE PRESS. TEMP.	PRESS.		
Type	Cp	Select the type of condenser management	M/S	INVERTER STEPS	INVERTER		
Condensation	Cq	Define the type of condenser	M/S	SINGLE SEPAR.	SINGLE		
N.Fans for circuit	Cq	Number of fans per circuit	M/S	1 to 3	1		
Rete freq.	Cr	Frequency of the electrical network	M/S	50 / 60 / err	50	Hz	
PWM Fase cut Triac max.:	Cs	Maximum voltage threshold for Triac	M/S	0 to 100	75	%	
Triac min.:	Cs	Minimum voltage threshold for Triac	M/S	0 to 100	25	%	
Range wave	Cs	Triac impulse duration	M/S	0 to 10.0	25	ms	
PARAMETERS →							
Rotation comp.	G0	Select the type of compressor rotation	M	L.I.F.O. F.I.F.O. TIME CUSTOM	F.I.F.O.		
Turn On oder	G1	Select the starting order of the compressors	M	0 to 8	0		
Turn Off oder	G1	Select the stopping order of the compressors	M	0 to 8	0		
Config.pump down Enable	G2	Enable pump down	M/S	N/Y	N		
Maximum time	G2	Maximum pump down time	M/S	0 to 999	60	s	
Start-up mode	G3	Configure the type of compressors and load step start	M	CppCppCpp CCCpppppp	CppCppCpp		
Start-up unl.mode	G3	Configure the type of load step start	M	p1p2p3p1p2p3 p1p1p1p2p2p2	p1p2p3p1p2p3 3		
Unloadres configuration Logic	G4	Configure the load step logic	M	N.C. N.O.	N.C.		
Condensation - set point	G5	Condenser control set point	M/S	0 to 99.9	14.0	Bar / °C	
Diff.	G5	Condenser control differential	M/S	0 to 99.9	2.0	Bar / °C	
Inverter Max.speed	G6	Maximum inverter speed	M/S	0 to 10.0	10.0	V	
Min.speed	G6	Minimum speed inverter	M/S	0 to 10.0	0	V	
Speed up time	G6	Inverter speed-up time	M/S	0 to 999	0	s	
Speed up time forced	G6	Speed-up time forced ON – compressors ON	M/S	0...999	0	S	
HP prevent Enable	G7	Enable high pressure prevention	M/S	N/Y	N		
Probe	G7	Select the probe for the high pressure prevention function	M/S	PRESSURE TEMPERATURE	PRESSURE		
Hp Prevenz. set point	G8	High pressure prevention set point	M/S	-99.9 to 99.9	20.0	Bar / °C	

Parameter	Ref.	Description	M/S	Range	Default	UOM	User value
Diff.	G8	High pressure prevention set point differential	M/S	0 to 99.9	2.0	Bar / °C	
Fan function type with condenser probe broken	G9	Behaviour of the software in the event of condenser probe fault	M/S	FORCE OFF, FORCE ON WITH COMP ON, LINKED TO THE TEMP.EAST	FORCE ON WITH COMP ON		
Condensation with temp.external set point	Ga	Condenser control set point on outside temperature (only with probe fault)	M/S	0T99.9	15.0	°C	
Diff.	Ga	Condenser control differential on outside temperature (only with probe fault)	M/S	0T99.9	5.0	°C	
Transducers high pressure alarm set point	Gb	High pressure alarm set point from transducer	M/S	-99.9 to 99.9	21.0	bar	
Diff.	Gb	High pressure alarm set point differential from transducer	M/S	0 to 99.9	2.0	Bar / °C	
Antifreeze alarm set point	Gc	Antifreeze alarm set point	M/S	-99.9 to 99.9	3.0	Bar / °C	
Diff.	Gc	Antifreeze alarm set point differential	M/S	0 to 99.9	2.0	Bar / °C	
Antifreeze alarm Reset	Gd	Type of antifreeze alarm reset	M/S	MANUAL AUTOMATIC	MANUAL		
Dwlay	Gd	Antifreeze alarm delay	M/S	0 to 540	0	s	
Antifreez.heater set point	Ge	Set point for activation of the antifreeze heater	M/S	-99.9T99.9	5.0	°C	
Diff.	Ge	Set point differential for activation of the antifreeze heater	M/S	0T99.9	1.0	°C	
Unit config. freecooling Valve type	Gf	Select the type of freecooling valve	M	0 to 10 V ON/OFF	0 to 10 V		
Antifreeze Te	Gf	Antifreeze threshold to stop freecooling on out. temp	M	-99.9T99.9	-20.0	°C	
Reversing valve logic	Gg	Logic of the cycle reversing valves	M	N.C. N.O.	N.C.		
Remote compressors control management type	Gh	Type of management of compressor remote control	M	STEPS PROPORTIONAL	STEPS		
Alarm rele activation for	Gi	Select the alarm management relay	M	MASTER MST + SLV	MASTER		
CAREL EXV DRIVERS →							
Manuf. COMM-CH LOP protection LOP limit	L1	LOP threshold in chiller operation	M/S	-70.0T50.0	-40.0	°C	
Int. factor	L1	Integral time for LOP management in chiller operation	M/S	0 to 25.5	4.0	s	
Manuf. COMM-HP LOP protection LOP limit	L2	LOP threshold in heat pump operation	M/S	-70.0T50.0	-40.0	°C	
Int. factor	L2	Integral time for LOP management in heat pump operation	M/S	0 to 25.5	4.0	s	
Manuf. COMM-DF LOP protection LOP limit	L3	LOP threshold in defrost operation	M/S	-70.0T50.0	-40.0	°C	
Int. factor	L3	Integral time for LOP management in defrost operation	M/S	0 to 25.5	4.0	s	
Manuf. COMM-CH MOP limit	L4	MOP threshold in chiller operation	M/S	-50.0T99.9	40.0	°C	
Int. factor	L4	Integral time for LOP management in chiller operation	M/S	0 to 25.5	4.0	s	
Start-up delay	L4	Delay at start-up of the MOP alarm in chiller operation	M/S	0 to 500	60	s	
Manuf. COMM-HP MOP limit	L5	MOP threshold in heat pump operation	M/S	-50.0T99.9	40.0	°C	
Int. factor	L5	Integral time for LOP management in heat pump operation	M/S	0 to 25.5	4.0	s	
Start-up delay	L5	Delay at start-up of the MOP alarm in heat pump operation	M/S	0 to 500	60	s	
Manuf. COMM-DF MOP limit	L6	MOP threshold in defrost operation	M/S	-50.0T99.9	40.0	°C	
Int. factor	L6	Integral time for LOP management in defrost operation	M/S	0 to 25.5	4.0	s	
Start-up delay	L6	Delay at start-up of the MOP alarm in defrost operation	M/S	0 to 500	60	s	
Manuf. COMM-CH Hi TCond.protection HiTcond limit	L7	High condensing temperature protection threshold in chiller operation	M/S	0T99.9	75.0	°C	
Int. factor	L7	Integral time for high condensing temperature threshold in chiller operation	M/S	0 to 25,5	4,0	s	
Manuf. COMM-HP Hi TCond.protection HiTcond limit	L8	High condensing temperature protection threshold in heat pump operation	M/S	0T99.9	75.0	°C	
Int. factor	L8	Integral time for high condensing temperature threshold in heat pump operation	M/S	0 to 25,5	4,0	s	
Manuf. COMM-DF Hi TCond.protection HiTcond limit	L9	High condensing temperature protection threshold in defrost operation	M/S	0T99.9	75.0	°C	
Int. time	L9	Integral time for high condensing temperature threshold in defrost operation	M/S	0 to 25,5	4,0	s	
Manuf. COMM-CH Suction temp. high limit	La	High suction temperature threshold in chiller operation	M/S	-99.9T99.9	30.0	°C	
Manuf. COMM-HP Suction temp. high limit	Lb	High suction temperature threshold in heat pump operation	M/S	-99.9T99.9	30.0	°C	
Manuf. COMM-DF Suction temp. high limit	Lc	High suction temperature threshold in defrost operation	M/S	-99.9T99.9	30.0	°C	
Manuf. COMM Custom valve conf. Minimum steps	Ld	Custom Valve: minimum steps	M/S	0 to 8100	0	Steps	
Maximum steps	Ld	Custom Valve: maximum steps	M/S	0 to 8100	1600	Steps	

Parameter	Ref.	Description	M/S	Range	Default	UOM	User value
Manuf. COMM Custom valve conf. Minimum steps	Ld	Custom Valve: minimum steps	M/S	0 to 8100	0	Steps	
Manuf. COMM Custom valve conf. Closing steps	Le	Custom Valve: closing steps	M/S	0 to 8100	3600	Steps	
Back steps	Le	Custom Valve: return steps	M/S	0 to 8100	0	Steps	
Manuf. COMM Custom valve conf. Opening EXTRAS	Lf	Custom Valve: enable extra step in opening	M/S	Y/N	N		
Closing EXTRAS	Lf	Custom Valve: enable extra step in closing	M/S	Y/N	N		
Manuf. COMM Custom valve conf. Phase current	Lg	Custom Valve: operating current	M/S	0 to 1000	250	mA	
Still current	Lg	Custom Valve: standby current	M/S	0 to 1000	100	mA	
Manuf. COMM Custom valve conf. Step rate	Lh	Custom Valve: frequency	M/S	32 to 501	100	Hz	
Duty-cycle	Lh	Custom Valve: duty cycle	M/S	0 to 100	50	%	
Manuf. COMM Evap.pressure probe Min value	Li	Minimum evap. pressure probe value.	M/S	-9.9 to 99.9	-0.5	bar	
Max value	Li	Maximum evap. pressure probe value.	M/S	3.5 to 99.9	7.0	bar	
Manuf. COMM Alarms delay Low SHEat	Lj	Low superheating alarm delay	M/S	0 to 3600	0	s	
High TSuct	Lj	High inlet temperature alarm delay	M/S	0 to 3600	0	s	
Manuf. COMM Alarms delay LOP	Lk	LOP alarm delay	M/S	0 to 3600	0	s	
MOP	Lk	MOP alarm delay	M/S	0 to 3600	0	s	
Manuf. COMM Refrigerant	LI	Select the type of refrigerant	M/S	---, R22, R134a, R404a, R407c, R410a, R507c, R290, R600, R600a, R717-NH3, R744	R407c		
Parameter Valve type	B0/E0/ F0/J0	Select the type of valve	M/S	See par. 8.1	CUSTOM		
Battery presence	B0/E0/ F0/J0	Enable backup battery	M/S	Y/N	N		
Circuit/EV Ratio	B1/E1/ F1/J1	Percentage ratio between cooling capacity and driver power	M/S	0 to 100	60	%	
Parameter-CH SHEat set.	B2/F2	Superheat set point in chiller operation	M/S	20.0T50.0	6.0	°C	
Dead zone	B2/F2	Dead zone in chiller mode	M/S	0T9.9	0	°C	
Parameter-CH Prop. factor	B3/F3	PID control – proportional gain in chiller operation	M/S	0 to 99.9	2.5		
Int. factor	B3/F3	PID control – integral time in chiller operation	M/S	0 to 999	25	s	
Diff. factor	B3/F3	PID control – derivative time in chiller operation	M/S	0 to 99.9	2.5	s	
Parameter-CH Low SHEat protection Low limit	B4/F4	Threshold for low superheat protection in chiller operation	M/S	-4.0T21.0	2.0	°C	
Int. factor	B4/F4	Integral time for low superheat protection threshold in chiller operation	M/S	0 to 30.0	1.0	s	
Parameter-DF SHEat set.	B5/F5	Superheat set point in defrost operation	M/S	20.0T50.0	6.0	°C	
Dead zone	B5/F5	Dead zone in chiller mode	M/S	0T9.9	0	°C	
Parameter-DF Prop. factor	B6/F6	PID control – proportional gain in defrost operation	M/S	0 to 99.9	2.5		
Int. factor	B6/F6	PID control – integral time in defrost operation	M/S	0 to 999	25	s	
Diff. factor	B6/F6	PID control – derivative time in defrost operation	M/S	0 to 99.9	2.5	s	
Parameter-DF Low SHEat protection Low limit	B7/F7	Threshold for low superheat protection in defrost operation	M/S	-4.0T21.0	2.0	°C	
Int. factor	B7/F7	Integral time for low superheat protection threshold in defrost operation	M/S	0 to 30.0	1.0	s	
Parameter-HP SHEat set.	B8/E2/ F8/J2	Superheat set point in heat pump operation	M/S	20.0T50.0	6.0	°C	
Dead zone SH	B8/E2/ F8/J2	PID control – proportional gain in heat pump operation	M/S	0T9.9	0	°C	
Int. factor	B9/E3/ F9/J3	PID control – derivative time in heat pump operation	M/S	0 to 99.9	2.5	s	
Diff. Factor	Ba/E4/ Fa/J4	Threshold per low superheat protection in heat pump operation	M/S	-4.0T21.0	2.0	°C	
Parameter-HP Low SHEat protection Low limit SH	Ba/E4/ Fa/J4	Integral time threshold low superheat protection in heat pump operation	M/S	0 to 30.0	1.0	s	
Int. factor	Ba/E4/ Fa/J4	Tempo integrale soglia protezione basso superheat in funzionamento pompa di calore	M/S	0 to 30.0	1.0	s	
TEMPISTICHE →							
Unit config. Compressors PW time	T0	Part-winding time	M/S	0 to 9990	1000	s	
Minimum comps power-on time	T1	Minimum compressor on time. Respected also in case of unit OFF	M	0 to 9999	60	s	
Minimum comps power-off time	T1	Minimum compressor off time. Respected each pCO* power on.	M	0 to 9999	360	s	
Min time betw. diff comp start	T2	Minimum time between starts of different compressors	M	0 to 9999	10	s	
Min time betw. Same comp starts	T2	Minimum time between starts of the same compressor	M	0 to 9999	450	s	
Unloads configuration Delay time	T3	Minimum time between load steps	M	0 to 99	2	s	
Prevent Unloads switching on delay	T4	Delay in activating load step in the event of high pressure pre-alarm	M/S	0 to 99	0	s	
Exit delay	T4	Delay in exiting high pressure pre-alarm	M/S	0 to 999	0	s	
AI flow evaporator Startup delay	T5	Evaporator flow switch alarm delay at start-up	M/S	0 to 999	15	s	
Run delay	T5	Evaporator flow switch alarm delay in stable operation	M/S	0 to 999	3	s	

Parameter	Ref.	Description	M/S	Range	Default	UOM	User value
Al flow Condensator Startup delay	T6	Condenser flow switch alarm delay at start-up	M/S	0 to 999	15	s	
Run delay	T6	Condenser flow switch alarm delay in stable operation	M/S	0 to 999	3	s	
Low pressure alarm Startup delay	T7	Low pressure alarm delay at start-up	M/S	0 to 999	40	s	
Run delay	T7	Low pressure alarm delay in stable operation	M/S	0 to 999	0	s	
Differential oil alarm Startup delay	T8	Oil differential alarm delay at start-up	M/S	0 to 999	120	s	
Run delay	T8	Oil differential alarm delay in stable operation	M/S	0 to 999	10	s	
INITIALISATION →							
Reset all parameters to default values	V0	Reset unit to the default values	M/S	Y/N	N		
new password Manufactory: Maintanace: User:	V1	Modify the password to access the manufacturer, maintenance and user branches.	M/S	0 to 9999	1234		
INPUTS/OUTPUTS		15-button terminal INPUTS/OUTPUTS button	PGD0 6 button or built-in terminal PRG button and INPUTS/OUTPUTS in the menu				
pCO INPUTS AND OUTPUTS →							
Inputs analog 1-2:	I0	Value of the probes connected to analogue inputs 1 and 2	M/S			% / °C / bar	
Inputs analog 3-4:	I1	Value of the probes connected to analogue inputs 3 and 4	M/S			% / °C / bar	
Inputs analog 5-6:	I2	Value of the probes connected to analogue inputs 5 and 6	M/S			% / °C / bar	
Inputs analog 7-8:	I3	Value of the probes connected to analogue inputs 7 and 8	M/S			% / °C / bar	
Dig.Input 1-3:	I4	Status of digital inputs from 1 to 3	M/S				
Dig.Input 4-6:	I5	Status of digital inputs from 4 to 6	M/S				
Dig.Input 7-9:	I6	Status of digital inputs from 7 to 9	M/S				
Dig.Input 10-12:	I7	Status of digital inputs from 10 to 12	M/S				
Dig.Input 13-14:	I8	Status of digital inputs from 13 to 14	M/S				
Dig.Output 1-3:	I9	Status of digital outputs from 1 to 3	M/S				
Dig.Output 4-6:	Ia	Status of digital outputs from 4 to 6	M/S				
Dig.Output 7-9:	Ib	Status of digital outputs from 7 to 9	M/S				
Dig.Output 10-11:	Ic	Status of digital outputs from 10 to 11	M/S				
Dig.Output 12-13:	Id	Status of digital outputs from 12 to 13	M/S				
Output analog 1-2:	Ie	Status of analogue outputs from 1 to 2	M/S			V	
Output analog 3-4:	If	Status of analogue outputs from 3 to 4	M/S			V	
DRIVER INPUTS AND OUTPUTS →							
Driver 1 Circ.1 - EEV	N0	Valve operating mode	M/S				
Valve Position	N0	Current valve position	M/S				Step
Power request	N0	Compressor capacity requested	M/S				%
Driver 1 Circ.1 SuperHeat	N1	Current SuperHeat	M/S				°C
Evap.Temp.	N1	Current evaporation temperature	M/S				°C
Suct.Temp.	N1	Current suction temperature	M/S				°C
Driver 1 Circ.1 Evap.Press.	N2	Current evaporation pressure	M/S				Bar
Evap.Temp.	N2	Current evaporation temperature	M/S				°C
Driver 1 Circ.1 Cond.Press.	N3	Current condensing pressure	M/S				Bar
Cond.Temp.	N3	Current condensing temperature	M/S				°C
batt.state	N4	Current battery status	M/S				
Driver 2 Circ.1 EEV	N5	Valve operating mode	M/S				
Valve Position	N5	Current valve position	M/S				Step
Power request	N5	Compressor capacity requested	M/S				%
Driver 2 Circ.1 SuperHeat	N6	Current SuperHeat	M/S				°C
Evap.Temp.	N6	Current evaporation temperature	M/S				°C
Suct.Temp.	N6	Current suction temperature	M/S				°C
Driver 2 Circ.1 Evap.Press.	N7	Current evaporation pressure	M/S				Bar
Evap.Temp.	N7	Current evaporation temperature	M/S				°C
Driver 2 Circ.1 Cond.Press.	N8	Current condensing pressure	M/S				Bar
Cond.Temp.	N8	Current condensing temperature	M/S				°C
batt.state	N9	Current battery status	M/S				
Driver 1 Circ.2EEV	Na	Valve operating mode	M/S				
Valve Position	Na	Current valve position	M/S				Step
Power request	Na	Compressor capacity requested	M/S				%
Driver 1 Circ.2 SuperHeat	Nb	Current SuperHeat	M/S				°C
Evap.Temp.	Nb	Current evaporation temperature	M/S				°C
Suct.Temp.	Nb	Current suction temperature	M/S				°C
Driver 1 Circ.2 Evap.Press.	Nc	Current evaporation pressure	M/S				Bar
Evap.Temp.	Nc	Current evaporation temperature	M/S				°C
Driver 1 Circ.2 Cond.Press.	Nd	Current condensing pressure	M/S				Bar
Cond.Temp.	Nd	Current condensing temperature	M/S				°C
batt.state	Ne	Current battery status	M/S				
Driver 2 Circ.2 EEV	Nf	Valve operating mode	M/S				
Valve Position	Nf	Current valve position	M/S				Step
Power request	Nf	Compressor capacity requested	M/S				%
Driver 2 Circ.2 SuperHeat	Ng	Current SuperHeat	M/S				°C
Evap.Temp.	Ng	Current evaporation temperature	M/S				°C
Suct.Temp.	Ng	Current suction temperature	M/S				°C

Parameter	Ref.	Description	M/S	Range	Default	UOM	User value
Driver 2 Circ.2 Evap.Press.	Nh	Current evaporation pressure	M/S			Bar	
Evap.Temp.	Nh	Current evaporation temperature	M/S			°C	
Driver 2 Circ.2 Cond.Press.	Ni	Current condensing pressure	M/S			Bar	
Cond.Temp.	Ni	Current condensing temperature	M/S			°C	
batt.state	Nj	Current battery status	M/S				
Firmware version Circuit 1 Driver 1	Nk	Driver firmware, hardware and software version 1	M/S				
Driver 2	Nk	Driver firmware, hardware and software version 2	M/S				
Firmware version Circuit 2 Driver 1	Nl	Driver firmware, hardware and software version 1	M/S				
Driver 2	Nl	Driver firmware, hardware and software version 2	M/S				

8. Screens

The screens are sub-divided into 5 categories:

- **USER screens, not password-protected:** these are located in all the branches, except for "PROG" and "MENU+PROG", and show the values read by the probes, the status of the alarms, the operating hours of the devices, the time and date; they are also used to set the temperature and humidity set point and the clock. These screens are indicated by the "🔑" symbol in the following table of parameters.
- **USER screens, password-protected (1234, modifiable):** these are accessed by pressing the "PROG" button, and are used to set the main functions (times, set points, differentials) for the devices connected; the screens that relate to functions that are not available are not displayed. These screens are indicated by the "🔑" symbol in the following table of parameters.
- **MAINTENANCE screens, password-protected (1234, modifiable):** these are accessed by pressing the "MAINTENANCE" button, and are used for performing the periodical checks on the devices, calibrating the probes, modifying the operating hours and manually activating the devices. These screens are indicated by the "🔑" symbol in the following table of parameters.
- **MANUFACTURER screens, password-protected (1234, modifiable):** these are accessed by pressing the "MENU+PROG" buttons and are used to configure the air-conditioning unit, enable the main functions and select the devices connected. These screens are indicated by the "🔑" symbol in the following table of parameters.

8.1 List of the screens

The following list shows the screens available on the display. The columns in the table represent the loop of screens, with the first screen (A0, B0...) being the one that is displayed when pressing the corresponding button, after which the arrow buttons can be used to scroll the other screens. The codes (Ax, Bx, Cx...) are displayed in the top right corner of the screens, making them easy to identify. The meaning of the symbols 🔑, 🔑... is explained in the previous paragraph. The annotation PSW indicates screens that are protected by password.

ESC	
	
0	M0
0	M1

PRG MAINTENANCE	
	
0	A0
0	A1
0	A2
0	A3
0	A4
0	A5
0	A6
0	A7
PSW	A8
2	Aa
2	Ab
2	Ac
2	Ad
2	Ae
2	Af
2	Ag
2	Ah
2	Ai
2	Aj
2	Ak
2	Al
2	Am
2	An
2	Ao
2	Ap
2	Aq
2	Ar
2	As



PRG PRINTER	
	

PRG IN/OUT	
	
pCO inputs-outputs	0 I0
	0 I1
	0 I2
	0 I3
	0 I4
	0 I5
	0 I6
	0 I7
	0 I8
	0 I9
	0 Ia
	0 Ib
	0 Ic
	0 Id
	0 Ie
	0 If
Driver inputs-outputs	0 N0
	0 N1
	0 N2
	0 N3
	0 N4
	0 N5
	0 N6
	0 N7
	0 N8
	0 N9
	0 Na
	0 Nb
	0 Nc
	0 Nd
	0 Ne
	0 Nf
	0 Ng
	0 Nh
	0 Ni
	0 Nj
	0 Nk
	0 Nl

PRG CLOCK	
	
0	K0
0	K1
PSW	K2
2	K3
2	K4
2	K5
2	K6
2	K7
2	K8
2	K9
2	Ka

PRG SET POINT	
	
0	S0
0	S1
0	S2
0	S3
0	S4

PRG USER	
	
PSW	P0
Temp. control	1 P1
	1 P2
	1 P3
	1 P4
	1 P5
	1 P6
	1 P7
	1 P8
	1 P9
	1 Pa
	1 Pb
	1 Pc
	1 Pd
	1 Pe
	1 Pf
	1 Pg
Freecooling	1 x1
	1 x2
	1 x3
	1 x4
	1 x5
Defrost	1 Q0
	1 Q1
	1 Q2
	1 Q3
	1 Q4
Various parameters	1 R0
	1 R1
	1 R2
	1 R3
	1 R4
	1 R5
	1 R6
	1 R7
	1 R8
	1 R9
	1 Ra
	1 Rb

PRG MANUFACTURER	
	
	+
PSW	Z0
CONFIGURATION	3 C0
	3 C1
	3 C2
	3 C3
	3 C4
	3 C5
	3 C6
	3 C7
	3 C8
	3 C9
	3 Ca
	3 Cb
	3 Cc
	3 Cd
	3 Ce
	3 Cf
	3 Cg
	3 Ch
	3 Ci
	3 Cj
	3 Ck
	3 Cl
	3 Cm
	3 Cn
	3 Co
	3 Cp
	3 Cq
	3 Cr
	3 Cs
PARAMETERS	3 G0
	3 G1
	3 G2
	3 G3
	3 G4
	3 G5
	3 G6
	3 G7
	3 G8
	3 G9
	3 Ga
	3 Gb
	3 Gc
	3 Gd
	3 Ge
	3 Gf
	3 Gg
	3 Gh
	3 Gi
CAREL EXV DRIVER→	3 L1
	3 L2
	3 L3
	3 L4
	3 L5
	3 L6
	3 L7
	3 L8
	3 L9
	3 La

ESC	PRG MAINTENANCE	PRG PRINTER	PRG IN/OUT	PRG CLOCK	PRG SET POINT	PRG USER	PRG MANUFACTURER
							Ⓢ Lb
							Ⓢ Lc
							Ⓢ Ld
							Ⓢ Le
							Ⓢ Lf
							Ⓢ Lg
							Ⓢ Lh
							Ⓢ Li
							Ⓢ Lj
							Ⓢ Lk
							Ⓢ Ll
							DRIVER 1 CIRC. 1→ Ⓢ B0
							Ⓢ B1
							Ⓢ B2
							Ⓢ B3
							Ⓢ B4
							Ⓢ B5
							Ⓢ B6
							Ⓢ B7
							Ⓢ B8
							Ⓢ B9
							Ⓢ Ba
							DRIVER 2 CIRC. 1→ Ⓢ E0
							Ⓢ E1
							Ⓢ E2
							Ⓢ E3
							Ⓢ E4
							DRIVER 1 CIRC. 2→ Ⓢ F0
							Ⓢ F1
							Ⓢ F2
							Ⓢ F3
							Ⓢ F4
							Ⓢ F5
							Ⓢ F6
							Ⓢ F7
							Ⓢ F8
							Ⓢ F9
							Ⓢ Fa
							DRIVER 2 CIRC. 1→ Ⓢ J0
							Ⓢ J1
							Ⓢ J2
							Ⓢ J3
							Ⓢ J4
							TIMES → Ⓢ T0
							Ⓢ T1
							Ⓢ T2
							Ⓢ T3
							Ⓢ T4
							Ⓢ T5
							Ⓢ T6
							Ⓢ T7
							Ⓢ T8
							INITIALISATION Ⓢ V0
							Ⓢ V1

9. EVD200 electronic expansion valve

The EVDriver module for the control of electronic expansion valves (EEV) in pLAN networks allows superheating control on the suction side for a more efficient and versatile operation of the refrigerating unit.

Efficient because the optimisation and stabilisation of the flow of refrigerant to the evaporator increases the overall performance of the installation, at the same time guaranteeing the safety (less activations of the low pressure switch, less return of liquid refrigerant to the compressor,...). In addition, if the EEV is correctly sized, the use of floating condensing (and evaporation) pressure or a low set point significantly increases the efficiency of the installation, guaranteeing lower energy consumption, with higher cooling efficiency. Versatile because the electronic expansion valve allows the use of compressors with different capacities and operating in different conditions.

The use of an expansion valve requires the installation not only of the EVDriver and the expansion valve, but also of a temperature sensor and a pressure transducer, both fitted at the end of the evaporator on the refrigerant side (on the compressor intake pipe). See the diagram below to better understand the typical layout of the installation.

The priorities to be considered for the optimum control of the refrigeration system involve achieving a high and constant cooling efficiency, as well as low and stable superheat values.

The heart of the control system is a PID control algorithm, with settable superheat coefficients.

The following values can also be set:

LOW	(Low superheat with programmable integral time and threshold)
LOP	(Low evaporation pressure, operating only in transients, with programmable integral time and threshold)
MOP	(High evaporation pressure, with programmable integral time and threshold)
HiTcond	(High condensing pressure, activated with condensing pressure probe read by pCO, with programmable integral time and threshold)

9.1 Driver parameters

This section explains the fundamental parameters for setting up the driver. The description of the parameters includes the screen code, in brackets (see Chap. "LIST OF PARAMETERS") to assist the identification of the parameter. Each pCO* board can manage a maximum of four drivers. As the configuration is identical for both, this section will only describe the configuration of the first driver.

For the installation of the optimum values of the parameters described below, refer to the instruction sheet enclosed with the electronic valve driver.

Type of valve and use of the battery (B0/E0/F0/J0)

The first screen is used to set the type of valve and the presence of the battery. The following valves are possible:

- Alco (EX5, EX6, EX7, EX8)
- Sporlan (SEI 0.5, SEI 1, SEI 2, SEI 3.5, SEI 6, SEI 8.5, SEH 100, SEH 175, SEH 250)
- Danfoss (ETS50, ETS100)
- CAREL E2V
- Custom valve (when the valve used is not described above).

Percentage ratio circ./EEV (B1/E1/F1/J1)

This indicates the ratio, expressed as a percentage, between the maximum cooling capacity of the circuit controlled by the EVDriver and the capacity attainable with the maximum opening of the expansion valve, in the same normal operating conditions. Normal operating conditions refer to all the installation variables that affect the refrigerating performance and the installation of the valve (condenser subcooling temperature, superheat, pressure drop,...).

Superheat set point in CH/HP/DF operation (B2/F2/B8/F8/E2/J2/B5/F5)

Set point for superheating control. Values lower than 3°C are recommended.

Dead zone for superheating control. For temperatures between *Sheat Set - SH Dead zone* and *Sheat Set + SH Dead zone* the control is not active. For example, a dead zone value of 1°C, with a set point of 5°C, means that the superheating is free to change between 4°C and 6°C without the controller attempting to modify it. Outside of this interval, the algorithm starts controlling again. Values above 2°C are recommended.

Warning: The suffix -CH indicates that these parameters are used in chiller operation. The parameters must also be configured for heat pump and defrost operation.

PID parameters in CH/HP/DF operation (B3/B6/B9/F3/F6/F9E3/J3)

Constants used in the PID control of the EVDriver. These represent respectively:

- Proportional gain
- Integral time constant
- Derivative time constant

In this case too the configuration must be completed for all three types of operation.

Low superheat threshold in CH/HP/DF operation (B4/B7/BA/F4/F7/FA/E4/J4)

Low superheating threshold and corresponding integral constant for the activation of the low superheat protection. This protection function tends to close the valve. If the integral constant is equal to zero the protection is disabled. In this case too the configuration must be completed for all three types of operation.

LOP threshold in CH/HP/DF operation (L1/L2/L3)

Low suction pressure threshold and corresponding integral constant for the activation of the LOP protection. This protection function tends to open the electronic valve. If the integral constant is equal to zero the protection is disabled. In this case too the configuration must be completed for all three types of operation.

MOP threshold in CH/HP/DF operation (L4/L5/L6)

High suction pressure threshold and corresponding integral constant for the activation of the MOP protection. This protection function tends to close the electronic valves. If the integral constant is equal to zero the protection is disabled. In this case too the configuration must be completed for all three types of operation

High condensing temperature threshold in CH/HP/DF operation (L7/L8/L9)

High condensing temperature threshold and corresponding integral constant for the activation of the protection function. This protection function tends to close the electronic valves. If the integral constant is equal to zero the protection is disabled. In this case too the configuration must be completed for all three types of operation.

Refrigerant (LI)

Type of refrigerant used in the unit.

Configuration of the evaporation pressure probe (Li)

This screen is used to set the minimum and maximum values for the range of the refrigerant pressure probe installed at the outlet of the evaporator connected to the driver.

9.2 Special "Ignore" function

This function is found under the maintenance branch

```
+-----+
|Driver 1 status  An|
|Standby unot for|
|Valve pen restart|
|Go ahead? N     |
+-----+
```

```
+-----+
|Driver 2 status  Ao|
|Standby unot for|
|Valve pen restart|
|Go ahead? N     |
+-----+
```

```
+-----+
|Driver 3 status  Ap|
|Standby unot for|
|Valve pen restart|
|Go ahead? N     |
+-----+
```

```
+-----+
|Driver 4 status  Aq|
|Standby unot for|
|Valve pen restart|
|Go ahead? N     |
+-----+
```

There are three alarm conditions that prevent the driver from performing the normal control functions (one of these is displayed above):

- open valve → during the last blackout the valve was not closed completely
- recharge battery → the battery is not working correctly or alternatively is discharged or not connected
- reboot EEPROM → EEPROM malfunction

When one of these conditions is active, the following alarm is displayed:

```
+-----+
|U:1           AL110|
|Dl Circl:Waiting for|
|Eeprom/batt.charged|
|or open valve error|
+-----+
```

By using the "Ignore" function, these alarms can be ignored so as to allow the valve to be controlled by the driver (which otherwise would continue to keep it closed).

WARNING! deleting the alarms means ignoring them, and consequently it is recommended to carefully check that the system is not damaged or malfunctioning or becomes unreliable (e.g.: if "recharge battery" is signalled, it probably means that the battery is not charged or is not connected, etc. Consequently, in the event of a blackout, it may not be able to close the valve. The valve would thus remain open when the installation starts again).

If none of the three alarms described above is present, the following screen is displayed:

```
+-----+
|Driver 1 status  An|
|                |
|No warnings     |
|                |
+-----+
```

10. Control

10.1 Control set point

Inputs used:

- Analogue input for remote set point variation
- Supervisor serial network

Parameters used:

- Control set point
- Enable remote set point from analogue input
- Limits for the calculation of remote set point from analogue input
- Display set point used by the control

Description of operation

Temperature control, irrespective of the type, is based on the setting of two fundamental parameters: control set point and band. The control set point can be changed according to special operating requirements of the unit. There are three different methods for changing the control set point:

1. Setting on the screen: by accessing the special screen, the user can directly set the value of the parameter.
2. Setting from the supervisor: if connected to a supervisory system, by accessing the special addresses, the cooling or heating set point can be set.
3. Setting from analogue input: enabling the remote set point control from analogue input (0 to 1 V / 0 to 10 V / 4 to 20mA selectable), allows compensation of the control set point by a proportional value between the two limits for the conversion of the input signal set.

All the above conditions may be active at the same time, while condition "1" is always present; the compensation of the set point from analogue input can be enabled by a special parameter, while setting from the supervisor is only possible using a board that is configured and connected for communication to a serial supervisor system.

In units that feature chiller + heat pump operation, the changeover from cooling to heating operation and vice-versa can be selected as automatic or manual. This setting defines how the temperature control set point is managed:

- Automatic changeover – one set point only for cooling and heating operation, based on which the unit changes operating mode;
- Manual changeover – two distinct set points, one for cooling operation, the other for heating operation, activated alternatively depending on the unit operating mode selected unit.

10.2 Temperature control

Two distinct modes are available for the operation of the temperature controller:

- Control depending on the temperature of the water measured by the probe located at the evaporator inlet
- Control depending on the temperature of the water measured by the probe located at the evaporator outlet

The first case involves proportional control based on the absolute value of the temperature measured by the probe; the second case involves dead zone control based on the time the temperature measured by the probe remains over certain thresholds.

10.3 Inlet temperature control

Inputs used

- Inlet temperature

Parameters used:

- Control set point
- Proportional band for inlet control.
- Type of control (proportional or proportional + integral)
- Integral time (if proportional + integral control is enabled)
- Type of unit
- Total number of compressors
- Number of load steps

Outputs used

- All the compressors and the corresponding load steps

Description of operation

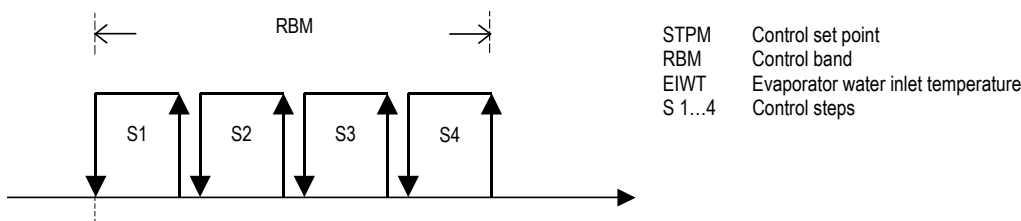

Fig. 10.1 Proportional temperature control based on the reading of the inlet probe

The temperature control depends on the values measured by the temperature probe located at the evaporator inlet, and follows proportional logic. Depending on the total number of compressors configured and the number of load steps per compressor, the control band set will be divided into a number of steps of the same amplitude. When the various thresholds are exceeded, a compressor load step will be activated

The following relationships are applied to determine of the activation thresholds:

Total number of control steps = Number of compressors + (Number of compressors * Number load steps/compressor).

Proportional step amplitude = Proportional control band / Total number of control steps

Step activation threshold = Control set point + (Proportional step amplitude * Progressive step [1,2,3,...]).

Example of temperature control in units with 4 compressors and 3 load steps each, in chiller operation:

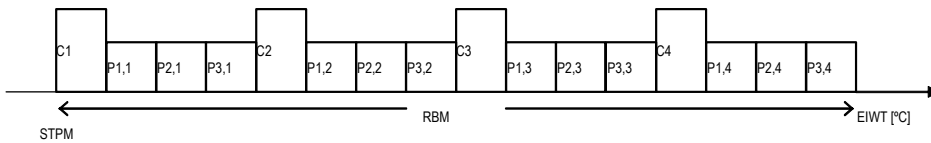

- STPM Control set point
- RBM Control band
- EIWT Evaporator water inlet temperature
- C 1...4 Compressors
- P 1...4,1...4 Compressor load steps

Fig. 10.2 Semi-hermetic compressors with proportional control

10.4 Outlet temperature control

Inputs used

- Outlet temperature

Parameters used

- Control set point
- Dead zone for outlet control
- Step activation delay
- Step deactivation delay
- Cooling outlet temperature limit
- Heating outlet temperature limit
- Minimum compressor on time
- Differential comprising the variation in the on time.
- Minimum compressor off time
- Differential comprising the variation in the off time.

Outputs used

- All the compressors and the corresponding load steps

Description of operation

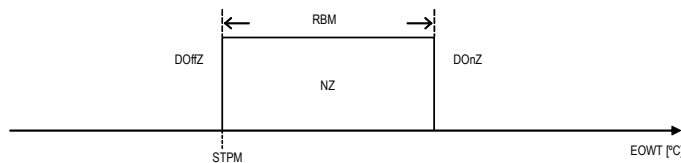

- STPM Control set point
- RBM Control band
- NZ Dead zone
- EOWT Evaporator water outlet temperature
- DOnZ Device start zone
- DOffZ Device stop zone

Fig. 10.3 Temperature control with dead zone based on the reading of the outlet probe

A temperature dead zone is identified based on the set point and band.

Temperature values between the set point and set point + band ($STPM \leq \text{Temperature} \leq STPM + RBM$) will not switch any compressors On/Off.

Temperature values above set point + band ($\text{Temperature} > STPM + RBM$) will activate the compressors

Temperature values below the set point ($\text{Temperature} < STPM$) will deactivate the compressors

A temperature threshold is envisaged, for both cooling operation and heating operation, below/above which the devices installed will in any case be stopped, in order to avoid excessive cooling/heating output produced by the unit.

Example of temperature control in units with 4 compressors and 3 load steps each, in chiller operation:

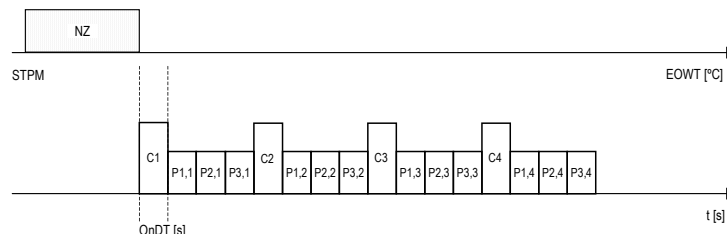

- STPM Control set point
- NZ Dead zone
- EOWT Evaporator water outlet temperature
- C 1...4 Compressors
- P 1...4,1...4 Compressor load steps
- OnDT Differential ignition compressors
- t Time

Fig. 10.4 Semi-hermetic compressors with dead zone control [start]

When the temperature is greater than STP_M + NZ, the devices are activated with a delay between the activations equal to the value set for the parameter "delay between starts in dead zone".

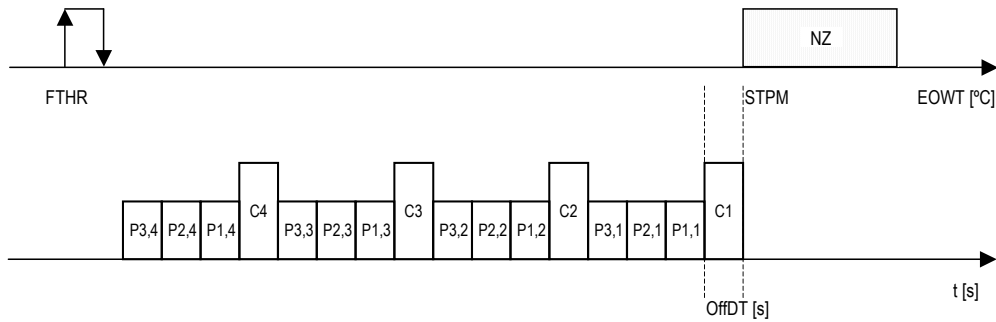

STPM	Control set point
NZ	Dead zone
EOWT	Evaporator water outlet temperature
FTHR	Forced shutdown threshold
C 1...4	Compressors
P 1...4, 1...4	Compressor load steps
OffDT	Differential shutdown compressors
T	Time

Fig. 10.5 Semi-hermetic compressors with dead zone control [stop]

When the temperature is less than STP_M, the devices are deactivated with a delay between deactivations equal to the value set for the parameter "delay between stops in dead zone". When the temperature falls below the minimum limit FTHR, the devices are switched off even if the delay time set has not elapsed; this helps avoid the activation of the antifreeze protection.

The user may also set a variable time between calls depending on how far the temperature is out of the dead zone. Specifically, the step request / deactivation time decreases (within certain limits) depending on the deviation of the temperature.

To do this, the following parameters need to be configured:

- Maximum compressor on time
- Minimum compressor on time
- Differential comprising the variation in the type of call.
- Maximum compressor off time
- Minimum compressor off time
- Differential comprising the variation in the off time.

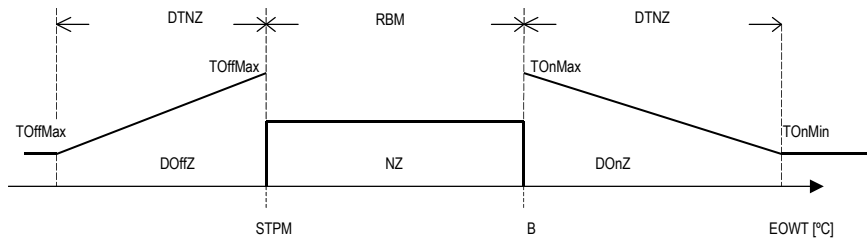

STPM	Control set point
RBM	Control band
NZ	Dead zone
EOWT	Evaporator water outlet temperature
DOnZ	Device start zone
DOffZ	Device stop zone
DTNZ	Differential comprising the variation in the time

The following cases are therefore possible in the start phase:

1. Inlet temperature equal to point b
type of call equal to "Maximum compressor on time"
2. Outlet temp. between point b and (point b + DTNZ)
type of call between "Max on time" and "Min on time"
3. Outlet temp. greater than or equal to (point b + DTNZ)
type of call equal to "Min on time"

The following cases, on the other hand, are possible in the stop phase:

1. Inlet temperature equal to point STPM
type of call equal to "Maximum compressor off time"
2. Outlet temp. between point STPM and (point STPM - DTNZ)
type of call between "Max off time" and "Min off time"
3. Outlet temp. greater than or equal to (point STPM - DTNZ)
type of call equal to "Min off time"

The function is disabled if the "minimum compressor on / off time" is equal to the maximum time.

11. Compressor control

The program can manage compressors all with the same capacity. Each compressor is associated with digital inputs used for safety functions and outputs used for enabling on power-up and to control any load steps.

11.1 Enable compressors from the screen

Maintenance branch, screen AH.

A compressor can be temporarily excluded by the controller.

This function is very useful when maintenance is required on the individual compressor.

The alarms on the compressor that has been disabled are also disabled.

11.2 Compressor rotation

Manufacturer branch, general parameters, screen G0,G1

The compressor calls are rotated so as to balance the number of operating hours and starts between the devices.

Rotation is only performed between the compressors and not between the load steps.

The rotation function automatically excludes any compressors with alarms or timers in progress.

If a compressor stops due to an alarm, another compressor will immediately be started.

Four different types of rotation can be set:

LIFO rotation

The first compressor to start will be the last to stop.

- Start: C1,C2,C3,C4,C5,C6,....,C8.
- Stop: C8,C7,C6,C5,C4,C3,....,C1.

FIFO rotation

The first compressor to start will be the first to stop.

Initially there may be large differences between on the operating hours of the various compressors, however in normal operating conditions the number of hours will tend to balance out.

- Start: C1,C2,C3,C4,C5,....C8
- Stop: C1,C2,C3,C4,C5,....C8.

Rotation based on the number of operating hours

The compressor with the lowest number of operating hours starts first. When stopping the opposite occurs, that is, when deactivation is requested, the compressor with the highest number of operating hours will stop

“Custom” rotation

The user assigns a personal order for the activation and deactivation of the compressors.

The position, in starting and shutting down order indicates the compressor (from left to right: first field = compressor 1, second field = compressor 2, and so on) and the number indicates the priority in starting (weight).

Example:

4 tandem compressors

```

+-----+
|Turn on order   G1|
| 1 3 2 4 6 8 7 5|
|Turn off order  |
| 2 3 1 4 8 5 6 7|
+-----+
    
```

Result

The devices start in the following sequence: compressor 1 (weight 1), compressor 3 (weight 2), compressor 2(weight 3), compressor 4 (weight 4).

They stop in the following sequence: compressor 3 (weight 1), compressor 1(weight 2), compressor 2(weight 3), compressor 4 (weight 4).

Note:

The compressors disabled on screen Ah (maintenance) doe not take part in the rotation functions and are always off.

11.3 Compressor times

Minimum compressor on time. - Manufacturer branch, general parameters, screen T1.

This represents the minimum compressor running time, whereby the compressors, once started, must remain on for this time before being stopped. It is respected also after a unit OFF.

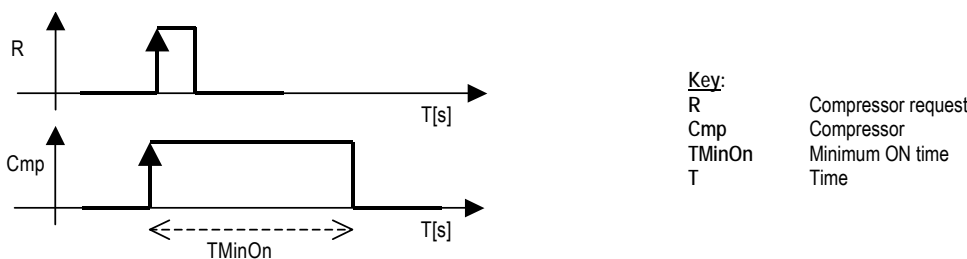
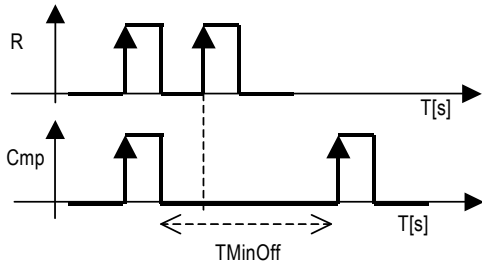

Fig. 10.1

Minimum compressor off time Manufacturer branch, general parameters, screen T1.

This represents the minimum compressor off time. The devices are not started again until the minimum time selected has elapsed since the last shutdown, Respected each pCO* power on.



<u>Key:</u>	
R	Compressor request
Cmp	Compressor
TMinOff	Minimum OFF time
T	Time

Fig. 10.2

Minimum time between starts of different compressors - Manufacturer branch, general parameters, screen T2.

This represents the minimum time that must elapse between the activation of one device and the next. This parameter is used to avoid simultaneous starts.

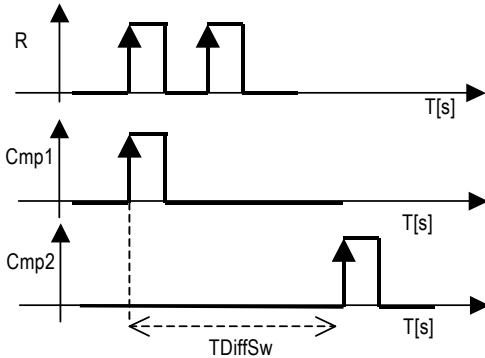

<u>Key:</u>	
R	Compressor requests
Cmp1	Compressor 1
Cmp2	Compressor 2
TDiffSw	Minimum time between starts of different compressors
T	Time

Fig. 10.3

Minimum time between starts of the same compressor - Manufacturer branch, general parameters, screen T2.

This establishes the minimum time that must elapse between two consecutive starts of the same compressor.

It is used to limit the number of starts per hour. If, for example, the maximum number of starts allowed per hour is 10, simply set a value of 360 seconds to ensure this limit is observed.

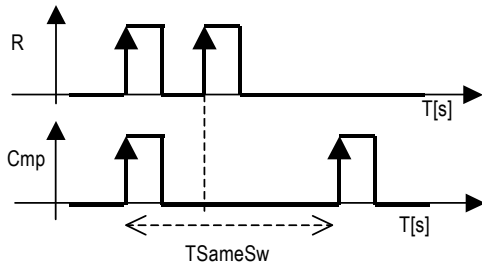

<u>Key:</u>	
R	Compressor request
Cmp	Compressor
TSameSw	Minimum time between starts of the same compressor
T	Time

Fig. 10.4

Minimum time between activation of load steps on the same compressor - Manufacturer branch, general parameters, screen T3.

This parameter is available only if the load steps have been selected.

It represents the minimum time that must elapse between the activation of two load steps or alternatively between the start of the compressor and part load operation. This prevents the compressor from starting at full load.

12. Condensing unit control

Inputs used

- Analogue input Bn (respectively B3 for pCO₂, pCO₃, B1 for pCO₁, B5 for pCO₀)

Parameters used

- Type of unit
- Type of remote control management
- Type of analogue input Bn

Outputs used

- All compressors

Description of operation

Condensing unit control involves the devices being called by a proportional voltage or current signal supplied by an external controller. The type of analogue input can be selected between 0 to 1 V, 0 to 10 V and 4 to 20 mA.

Two control modes are featured: proportional or steps, selected by a dedicated user parameter. As the compressors are called by an external controller, the corresponding control probes and parameters are not used.

12.1 Proportional control

Below is a description of operation with proportional control, when a 0 to 1 V analogue input is used.

```

+-----+
| Remote          Gh |
| compressors      |
| control management |
| Type  PROPORTIONAL |
+-----+

```

The compressor requests depend on the analogue input Bn, with continuous variation of the input signal, the board calculates the number of steps required based on the voltage value measured:

Analogue input	0 V	0% request (no compressor on)
Analogue input	1 V	100% request (all the compressors on)

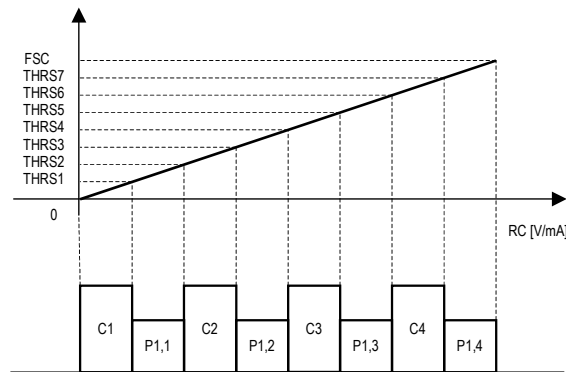

FSC	Analogue input end scale
THR S1...7	Activation threshold step 1 to 7
RC	Remote control signal
C 1...4	Compressors
P 1,1...4	Compressor load steps

Fig. 12.1 Condensing unit with proportional control

Example of control of a unit with 4 semi-hermetic compressors:

Number of pCO_x boards = 2

Total number of compressors = 4

Number of compressors per board = 2

Number of load steps per compressor = 1

Total number of steps = Total number of compressors + (Total number of compressors * Number of load steps per compressor) = 4 + 4 * 1 = 8

Amplitude of each step = Analogue input end scale / Total number of steps = 1 / 8 = 0.125V

If the analogue input Bn measures 0.25 Volts, two steps will be requested, therefore one compressor and one of its load steps will be activated (the switching of the load step relay will depend on the logic set)

Two safety thresholds are calculated for the total activation or deactivation of the compressors, if exceeded.

These thresholds are calculated according to the following relationships.

Forced shutdown threshold = Analogue input end scale / Total number of steps / 2 = 1 / 8 / 2 = 0.0625 V → 0.0 V

Forced start threshold = Analogue input end scale – Forced shutdown threshold = 1 – 0.0625 = 0.9375 V → 0.9 V.

If the reading of the analogue input Bn is less than the value of the forced shutdown threshold calculated, the devices will be stopped unconditionally.

If the reading of the analogue input Bn is greater than the value of the forced start threshold calculated, the devices will be started unconditionally.

12.2 Stepped control

Below is a description of operation with stepped control, using a 0 to 1 V analogue input.

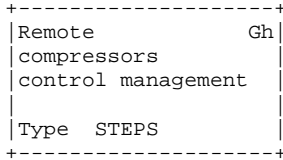

The compressor calls depend on the analogue input Bn, using a voltage divider or equivalent circuit to supply precise voltages that correspond to the activation or deactivation of the compressors and the relative load steps

If the analogue input Bn measures 0 Volt, all steps will be called.

If the analogue input Bn measures 1 Volt, no steps will be called.

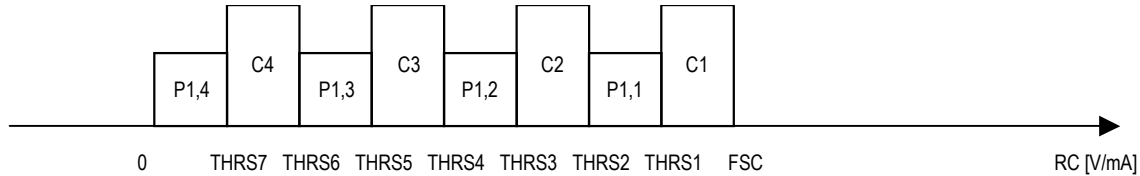

- FSC Analogue input end scale
- THR S1...7 Activation threshold step 1 to 7
- RC Remote control signal
- C 1...4 Compressors
- P 1,1...4 Compressor load steps

Fig. 12.2 Condensing unit with stepped control

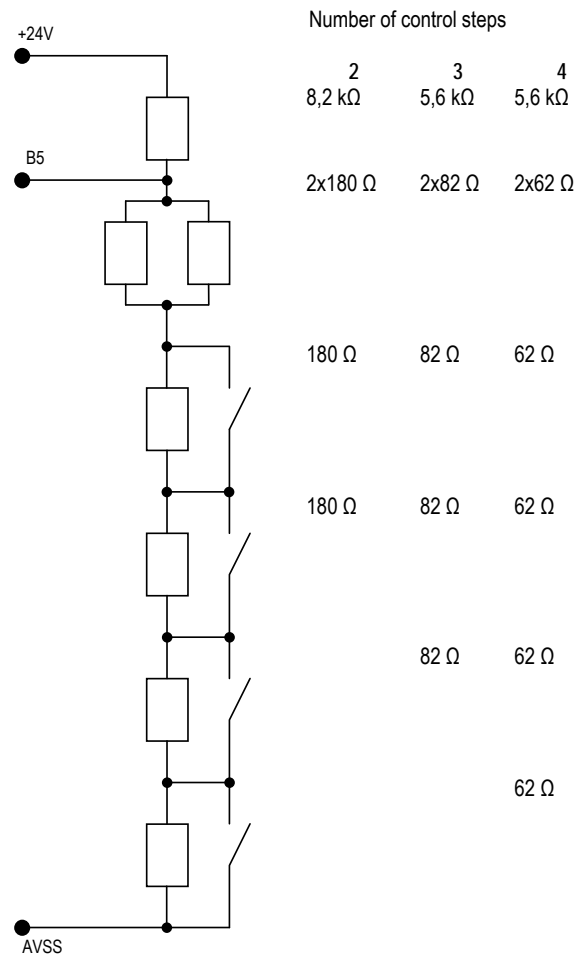

Example of control of a unit with 4 hermetic compressors (cfg 4):

- Number of pCOx boards = 1
- Total number of compressors = 4
- Number of compressors per board = 4

Total number of steps = Total number of compressors + (Total number of compressors * Number of load steps per compressor) = 4 + 4 * 0 = 4
 Amplitude of each step = Analogue input end scale / Total number of steps = 1 / 4 = 0.25V

If the analogue input Bn measures 0.680 Volt, two steps will be called, therefore one compressor will be activated.

To the side is a connection example of a resistive voltage divider for controlling condensing units by steps.

Volt	Percentage requirement	Numbe of steps called
0	100%	4
0.1	90%	3
0.2	80%	3
0.4	60%	2
0.5	50%	2
0.6	40%	1
0.7	30%	1
0.8	20%	0
0.9	10%	0
1	0%	0

13. Control of water/water units with reversal on the water circuit

Inputs used

- Evaporator water inlet temperature
- Evaporator water outlet temperature
- Condenser water inlet temperature
- Condenser water outlet temperature

Parameters used

- Type of unit
- Minimum evaporator outlet threshold
- Reversing valve logic

Outputs used

- Water circuit reversing valve

Description of operation

The water/water units with reversal on the water circuit feature control based on the values measured by different probes, based on whether the unit is in cooling or heating operation.

In chiller operation, the compressors are activated / deactivated based on the temperature values measured by the probes installed on the evaporator inlet and/or outlet.

In heat pump operation, the compressors are activated / deactivated based on the temperature values measured by the probes installed on the condenser inlet and/or outlet.

Heating operation is allowed only if the temperature measured at the evaporator outlet is greater than the minimum evaporator outlet threshold set. The operating logic of the digital output for the reversal of the water circuit depends on the setting of the corresponding manufacturer parameter. The configuration set by CAREL is:

- chiller operation relay energised
- heating operation relay de-energised

13.1 Cooling / Heating operation

Inputs used:

- Cooling/Heating digital input
- Supervisor serial network
- Inlet temperature
- Outlet temperature

Parameters used:

- Type of unit
- Select manual-automatic cool/heat changeover
- Enable change cooling/heating from digital input
- Enable change cooling/heating from supervisor serial network
- Logic of 4-way reversing valve in refrigerant / water circuit
- Dead zone for automatic changeover
- Select type of temperature control, inlet-outlet
- Device shutdown time for cooling-heating changeover
- Valve switching delay for reversing the refrigerant circuit

Outputs used:

- Refrigerant / water circuit reversing valve

Description of operation

In chiller + heat pump units, operation can change from cooling to heating or vice-versa "manually" or "automatically", according to the setting of the corresponding parameter.

13.1.1 Automatic changeover

The automatic changeover function allows the unit to switch from chiller to heat pump operation or vice-versa automatically, based on the control probe reading, in reference to a single control set point.

This function is available on both units controlled on the water temperature measured at the evaporator inlet, and units controlled on the water temperature measured at the evaporator outlet. There is a small difference in the management of the two modes due to the introduction of a dead zone for switching between operating modes.

Whatever mode is selected, the type of operation is displayed by the LEDs corresponding to the blue and red buttons on the display with 15 buttons:

- the LED corresponding to the blue button indicates operation in "cooling" mode
- the LED corresponding to the red button indicates operation in "heating" mode".

In any case, screen M1 always shows the unit status.

Control set point

The automatic changeover function foresees the operation of the unit with just one control set point, settable on the corresponding user screen, that manages the unit temperature control functions.

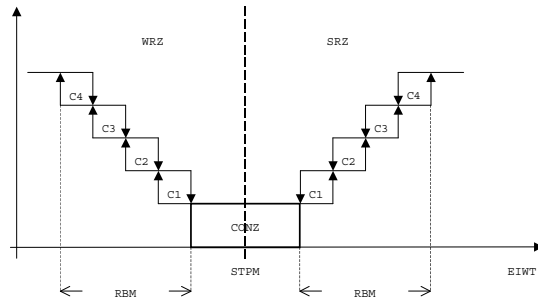

STPM	Control set point
RBM	Control band
CONZ	Changeover dead zone
EIWT	Evaporator water inlet temperature
WRZ	Heating control zone
SRZ	Cooling control zone
C 1...4	Compressors

Fig. 13.1 - Automatic changeover with inlet control

Considering a unit with inlet control (proportional or proportional+integral), the single control set point for chiller and heat pump operation is positioned in the centre of the changeover dead zone, as shown in the graph below. The cooling/heating steps will be called in the times and methods corresponding to the type of temperature control, according to proportional logic with a proportional band.

Assuming the temperature measured at the evaporator inlet moves from the cooling to the heating operation zone:

- the controller shuts down the compressors;
- the minimum on times, if relevant, keep the compressors on for a certain period;
- when the safety times expire the compressors are forced off for the set time;
- as soon as the temperature measured falls below the set point – dead zone/2, the refrigerating cycle reversing valve/valves switches/switch;
- after the delay time for the switching of the 4 way valves, set the unit is set in heating operation;
- after compressor forced shutdown time for changeover, the compressors are started according to the proportional temperature control requirement, observing any delay times between the starts of different devices.

The same switching sequence is applied when the temperature moves from the heating to the cooling operation zone.

While the temperature measured at the evaporator inlet is within the dead zone, no load will be activated and the 4 way valves remain in their current status.

Automatic changeover with outlet control

Considering a unit with outlet control, the control dead zone is also used as the dead zone for changeover, making the setting of the specific parameter redundant.

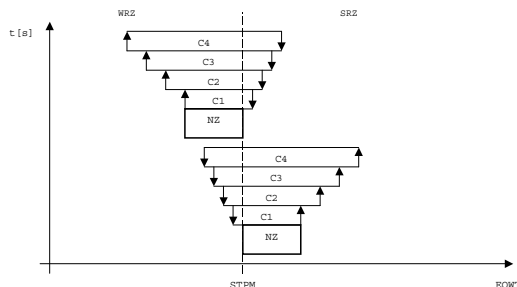

Fig. 13.2 - Automatic changeover with outlet control

STPM	Control set point
NZ	Control dead zone
EOWT	Evaporator water inlet temperature
WRZ	Heating control zone
SRZ	Cooling control zone
C 1...4	Compressors

The cooling/heating steps will be called in the times and methods corresponding to the type of temperature control, according to timed logic.

Assuming the temperature measured at the evaporator outlet moves from the cooling to the heating operation zone:

- the controller shuts down the compressors according to the shutdown times calculated;
- the minimum on times, if relevant, keep the compressors on for a certain period;
- when the safety times expire the compressors are forced off for the set time;
- as soon as the temperature measured falls below the set point – dead zone, the refrigerating cycle reversing valve/valves switches/switch;
- after the delay time for the switching of the 4 way valves, set the unit is set in heating operation;
- after compressor forced shutdown time for changeover, the compressors are started according to the proportional temperature control requirement, observing any delay times between the starts of different devices.

The same switching sequence is applied when the temperature moves from the heating to the cooling operation zone. While the temperature measured at the evaporator outlet is within the dead zone, no load will be activated and the 4 way valves remain in their current status.

13.1.2 Manual changeover

The changeover in operating mode is only possible when the unit is off (Circulating pump off). "Cooling" operation means that the unit is in chiller mode (production of cold water). "Heating" means that the unit is in heat pump mode (production of hot water).

The order that the various conditions are listed in represents the increasing priority of each (1 = maximum priority).

1. Digital input: if enabled by user parameter, changeover is possible by controlling the dedicated digital input.
2. Supervisor: if enabled by user parameter, changeover is possible by controlling the dedicated parameter via serial line.
3. Keypad: the changeover in operating mode is performed using the blue and red buttons (in the keypad to 15 buttons):
 - Blue button: "cooling" operation
 - Red button: "heating" operation

Whatever mode is selected, the type of operation is displayed by the LEDs corresponding to the blue and red buttons on the display:

- the LED corresponding to the blue button indicates operation in "cooling" mode
- the LED corresponding to the red button indicates operation in "heating" mode".

In any case, screen M1 always shows the unit status.

14. Pump down

Inputs used

- ON/OFF from the keypad
- ON/OFF from digital input
- ON/OFF from the supervisor
- Low pressure switch

Parameters used

- Enable pump down
- Maximum pump down time

Outputs used

- Compressors
- Liquid solenoid

Description of operation

When the conditions for the activation of the pump down function are true, the liquid solenoid valve will be closed and the compressor kept on until the end pump down conditions are true

Start pump down

The pump down procedure is activated when the compressor stops, either when the compressor request is absent or when the unit is shutdown.

As the control system operates in master-slave mode, and the individual slave boards can be switched off using the ON/OFF button on the shared display, the pump down procedure will be only performed on the circuits controlled by the slave boards that have been switched off.

If the compressor is shutdown due to a specific or circuit alarm, or the unit is shutdown due to a serious alarm, the pump down procedure will not be performed.

In units with hermetic compressors in tandem configuration, the pump down procedure will not be performed.

End pump down

The end of the pump down procedure may be dictated by the activation of the low pressure switch or when the time exceeds the maximum threshold set.

```

+-----+
| Config.pump down G2 |
+-----+
| Enable           N  |
+-----+
| Maximum time    000s|
+-----+
    
```

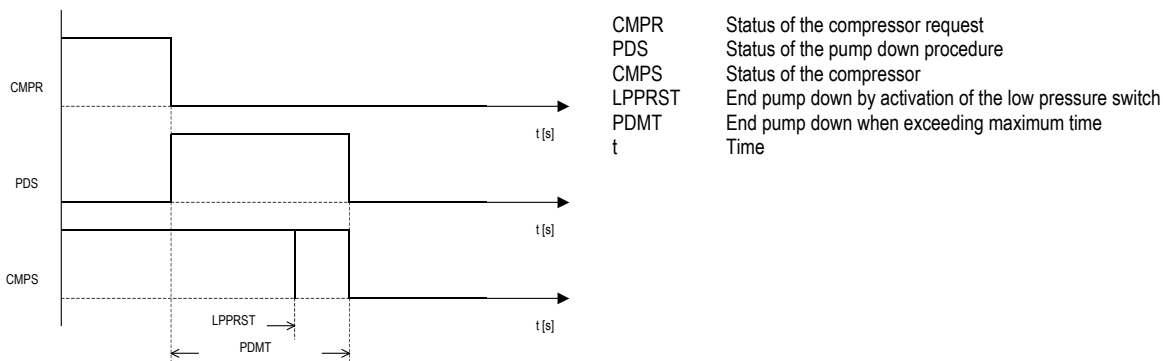

Fig. 14.1 Pump down procedure

15. Condenser control

Inputs used

- High pressure transducer circuit 1
- High pressure transducer circuit 2
- Condenser temperature probe circuit 1
- Condenser temperature probe circuit 2

Parameters used

- Select type of condenser control: none/pressure/temperature
- Type of condenser (Single / Separate)
- Condenser control set point
- Condenser control band
- Number of fans per coil
- Enable prevent function
- Prevent threshold
- Prevent differential
- Output voltage at minimum inverter speed
- Output voltage at maximum inverter speed
- Inverter speed-up time

Outputs used

- Condenser fan 1
- Condenser fan 2
- Condenser fan 3
- Condenser fan speed controller circuit 1
- Condenser fan speed controller circuit 2

ON/OFF condenser control linked to compressor operation

The operation of the fans depends exclusively on the operation of the compressors:

Compressor off = fan off Compressor on = fan on

No pressure transducers need to be installed.

ON/OFF condenser control linked to the pressure or temperature sensor

The operation of the fans is subordinate to the operation of the compressors and to the value read by the pressure or temperature sensors, according to a set point and a band. When the pressure/temperature is less than or equal to the set point, all the fans are off; when the pressure/temperature rises to the set-point + band, all the fans are started. Single- or separate-coil condenser control can be selected; with single-coil condenser control, the fans are controlled according to the highest pressure/temperature; with separate-coil condenser control, each pressure/temperature sensor controls its own fan.

Modulating condenser control linked to the pressure or temperature sensor

The fans are slaved to the operation of the compressors controlled using a 0 to 10 V or PWM analogue output proportional to the request of the pressure/temperature sensor. Single- or separate-coil condenser control can be selected; with single-coil condenser control, the fans are controlled according to the highest pressure/temperature; with separate-coil condenser control, each pressure/temperature sensor controls its own fan or group of fans. If the lower limit of the ramp is greater than 0 V, the line will not be proportional but rather, as seen in the first section of the graph, one step below the set point with an amplitude of 1.0 °C. When the compressors start, the fans will be activated at maximum output for a time equal to the compressor force on time. If this time is lower than the speed-up time on compressor power-up, the fans will remain on at maximum output for the speed-up time and not the force on time. In practice, when compressors are started, the fans consider the higher of the two times.

```

+-----+
|HP prevent      G7|
|Enable         S |
|Probe PRESSURE |
|               |
+-----+
    
```

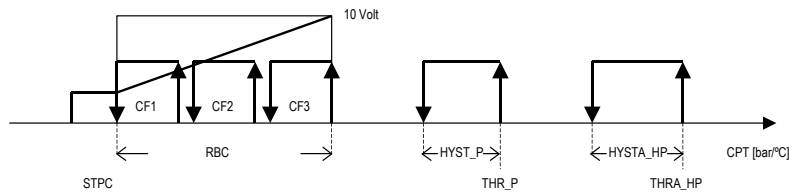

STPC	Condenser control set point	THRA_HP	High condenser pressure alarm threshold
RBC	Condenser control band	HYSTA_HP	High condenser pressure alarm hysteresis
THR_P	High condenser pressure prevention threshold	CPT	Condensing pressure / temperature
HYST_P	High condenser pressure prevention hysteresis	CF 1...3	Condenser fans (the total number depends on the type of unit)

Fig. 15.1 Control of the condensing devices and alarms

15.1 Prevent function

This function can be enabled in the manufacturer branch, and prevents the circuits from being shutdown due to a high pressure alarm. When the compressors are on, once reaching the set threshold, the capacity of the compressor is controlled until the pressure returns below the set point - differential. When the compressors are off, once having reached the set threshold, the fans are started at maximum speed until the pressure returns below the set point - hysteresis. In units with tandem hermetic compressors, the prevent function stops one of the compressors that is on by performing a rotation, so as to force off a different device each time. In units with capacity-controlled semi-hermetic compressors, the prevent function activates the load steps, while attempting to avoid shutting down the compressor.

In addition, a delay can be set for the activation of the individual load steps (this is valid for compressors with more than one load step) so as to allow the gradual decrease in capacity, as well as and a delay for the deactivation of the prevent function, which maintains the condition active even if the pressure/temperature is less than the threshold-hysteresis ($CPT < THR_P - HYST_P$).

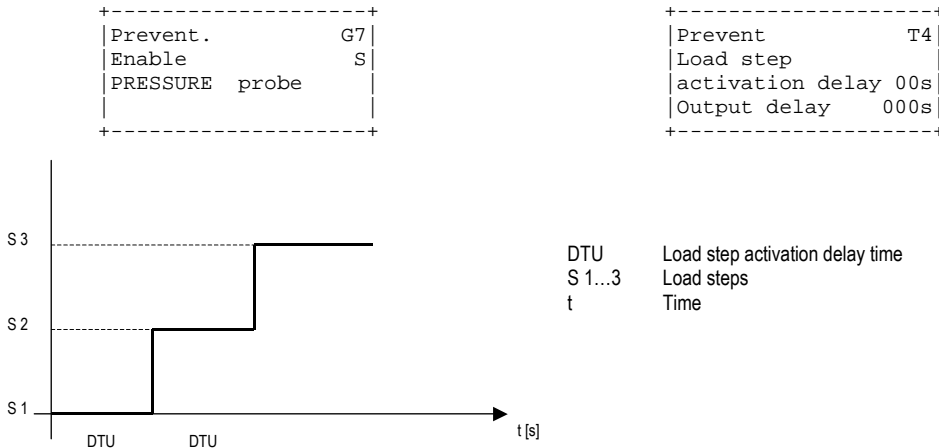

Fig. 15.2 Forcing of compressor load steps to prevent high condensing pressure

16. Defrost control for air/water units

Inputs used

- Coil temperature circuit 1
- Coil temperature circuit 2
- Defrost pressure switch circuit 1
- Defrost pressure switch circuit 2

Parameters used

- Type of global defrost
- Type of local defrost
- Start defrost threshold
- End defrost threshold
- Defrost delay time
- Maximum defrost time
- Forced compressor shutdown time for reversal of the refrigerant circuit
- Reverse cycle delay

Outputs used

- Compressor 1
- Compressor 2
- Compressor 3
- Compressor 4
- 4-way reversing valve circuit 1
- 4-way reversing valve circuit 2
- Condenser fans circuit 1
- Condenser fans circuit 2

16.1 Simultaneous global / Simultaneous local

Only one circuit needs to enter in the defrost cycle for all the circuits to be forced to defrost. The circuits which do not require defrost (temperature greater than the end defrost set point) stop and go to standby; as soon as all the circuits end their defrost cycle the compressors can start again in heat pump operation.

Separate global / Simultaneous local

This type of defrost involves separate defrosts between the various pCO* boards making up the system, and a simultaneous defrost in the circuits controlled by the same pCO* board. The first pCO* board that requests defrost starts defrosting (simultaneous for the circuits on that unit), while the other boards, even if they require defrost, go to standby (continue to operate in heat pump mode) until the first ends its defrost; only at the end of this will the following units start the procedure, placing the other boards that require defrost in standby.

Separate global / Separate local

The circuits are defrosted separately between both the boards and the circuits; the first circuit that requires defrosting starts the procedure, while the others wait and then proceed with the individual defrosts sequentially.

Independent global / Simultaneous local

The various pCO* boards making up the system can complete the defrost procedure absolutely independently, starting and ending at different times, even overlapping. The circuits controlled by each board perform the defrost in simultaneous mode, starting and ending at the same time.

Independent global / Separate local

The various pCO* boards making up the system can complete the defrost procedure absolutely independently, starting and ending at different times, even overlapping.

The circuits controlled by each board perform the defrost in separate mode, starting and ending sequentially.

```
+-----+
|Defrost config. Q0 |
|Probe TEMPERATURE |
|Global SIMULTANEOUS |
|Local SIMULTANEOUS |
+-----+
```

16.2 Defrosting a circuit with time/temperature control

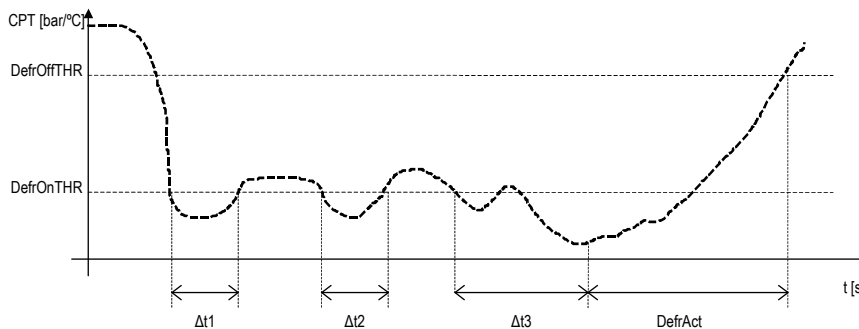

- DefrOffTHR End defrost threshold
- DefrOnTHR Start defrost threshold
- CPT Condensing pressure/temperature
- Δt 1...3 Partial duration of the pressure/temperature in the defrost activation zone
- DefrAct Defrost active
- t Time

Fig. 16.1 Defrost control

Description of operation

If the temperature/pressure of a coil remains below the start defrost set point for a cumulative time equal to the defrost delay time, the circuit in question will start a defrost cycle :

- the compressor/compressors in the circuit in question stop for a set time
- the refrigerant circuit is reversed using 4-way valve after a set delay
- the fan in question is switched off (if the pressure probes are present, the fan can be started at a certain threshold to prevent the circuit from reaching the high pressure alarm)

The circuit exits the defrost cycle if the temperature/pressure exceeds the end threshold, or after a maximum time, if the defrost cycle exceeds the maximum set threshold time.

16.3 Defrosting a circuit with time/pressure switch control

The activation / deactivation of the defrost cycle depends on the status of the high pressure switch in the circuit.

For this purpose, the analogue input used to measure the temperature of the condenser coil will be used as a digital input for reading of the status of the pressure switch. A free contact is required, which, if open, starts the defrost procedure, vice-versa if closed.

For defrost by pressure switch the duration of the procedure is also bound by the maximum threshold set, with the defrost ending after the maximum time.

```
+-----+
|Defrost          Q1 |
|Start           00.08C |
|Stop            00.08C |
+-----+
```

```
+-----+
|Defrost          Q3 |
|Compressors force |
|off when defrost  |
|begins/ends for 000s |
+-----+
```

```
+-----+
|Defrost          Q2 |
|Delay time       00000s |
|Maximum time     00000s |
+-----+
```

```
+-----+
|Defrost          Q4 |
|Reversing cycle  |
|delay            000s |
+-----+
```

17. Control of heat recovery units

Inputs used

- Evaporator water inlet temperature
- Evaporator water outlet temperature
- Recovery water inlet temperature
- Recovery water outlet temperature

Parameters used

- Priority recovery / utility
- Recovery control set point
- Recovery control band

Outputs used

- Valve A
- Valve B
- Valve C

17.1 Recovery priority

COOLING OPERATION

When the utility temperature controller is not at temperature and the recovery temperature controller is at temperature the unit will be in chiller only operation. The compressors are controlled according to the evaporator water temperature. When the utility temperature controller is not at temperature and the recovery temperature controller is not at temperature the unit will be in chiller + recovery operation. The compressors are controlled according to the recovery water temperature. When the utility temperature controller is at temperature and the recovery temperature controller is not at temperature the unit will be in recovery-only operation. The compressors are controlled according to the recovery water temperature.

HEATING OPERATION

When the utility temperature controller is not at temperature and the recovery temperature controller is at temperature the unit will be in heat pump operation. The compressors are controlled according to the evaporator water temperature. When the utility temperature controller is not at temperature and the recovery temperature controller is not at temperature the unit will be in recovery-only operation. The compressors are controlled according to the recovery water temperature. When the utility temperature controller is at temperature and the recovery temperature controller is not at temperature the unit will be in recovery-only operation. The compressors are controlled according to the recovery water temperature. If a defrost is required the unit will be in defrost operation.

17.2 Utility priority

COOLING OPERATION

When the utility temperature controller is not at temperature and the recovery temperature controller is at temperature the unit will be in chiller only operation. The compressors are controlled according to the evaporator water temperature.

When the utility temperature controller is not at temperature and the recovery temperature controller is not at temperature the unit will be in chiller + recovery operation. The compressors are controlled according to the evaporator water temperature.

When the utility temperature controller is at temperature and the recovery temperature controller is not at temperature the unit will be in recovery-only operation. The compressors are controlled according to the recovery water temperature.

HEATING OPERATION

When the utility temperature controller is not at temperature and the recovery temperature controller is at temperature the unit will be in heat pump operation. The compressors are controlled according to the evaporator water temperature.

When the utility temperature controller is not at temperature and the recovery temperature controller is not at temperature the unit will be in heat pump operation. The compressors are controlled according to the evaporator water temperature.

When the utility temperature controller is at temperature and the recovery temperature controller is not at temperature the unit will be in recovery-only operation. The compressors are controlled according to the recovery water temperature.

If a defrost is required the unit will be in defrost operation.

Valves

The different unit operating modes are controlled by three digital outputs connected to different valves, according to the following configurations:

Cooling operation

	Valve A (recovery)	Valve B (utility)	Valve C (cooling / heating)
Chiller-only	OFF	ON	OFF
Chiller + Recovery	ON	ON	OFF
Recovery-only	ON	OFF	OFF

Table 17.1 Configuration of the valves in cooling operation (units with heat recovery)

Heating operation

	Valve A (recovery)	Valve B (utility)	Valve C (cooling / heating)
Heat pump	OFF	ON	ON
Recovery-only	ON	OFF	ON
Defrost	OFF	OFF	ON

Table 17.2 Configuration of the valves in heating operation (units with heat recovery)

Notes on the condenser fans

In all unit operating modes, except for chiller+ recovery, the condenser fans are controlled according to the procedures described in the corresponding chapter.

18. Freecooling control

Inputs used

- Evaporator water outlet temperature
- Freecooling coil water inlet temperature
- Outside air temperature

Parameters used

- Type of unit
- Number of units
- Type of condenser control
- Number of fans
- Type of freecooling valve
- Type of freecooling control
- Integral time
- Control set point
- Control set point offset
- Minimum freecooling delta
- Maximum freecooling delta
- Freecooling control band
- Maximum freecooling valve opening threshold
- Minimum condenser speed control threshold
- Freecooling antifreeze threshold
- Compressor activation delay

Outputs used

- Condenser fans
- Condenser fan speed control
- ON/OFF freecooling valve
- 3-way freecooling valve

Description of operation

Freecooling control exploits the temperature of the outside air to assist in the cooling of the utility water. This function uses a heat exchanger, through which a special valve deviates a certain quantity of return water from the system. The favourable outside air temperature conditions thus cool the water prior to its return, and the activation of the cooling devices is therefore delayed. Freecooling is envisaged for air/water units in internal freecooling mode, that is, with the freecooling coil housed inside the unit near the condenser coil/coils, with which it shares the control of the condenser fan/fans.

FCT	Freecooling coil inlet temperature	CF 1...2	Condenser fans
FCV	Freecooling valve	CEXC	Condenser coil
EIWT	Evaporator water inlet temperature	FCEXC	Freecooling coil
EOWT	Evaporator water outlet temperature	EEXC	Evaporator coil
PCO2	PCO ² control board		

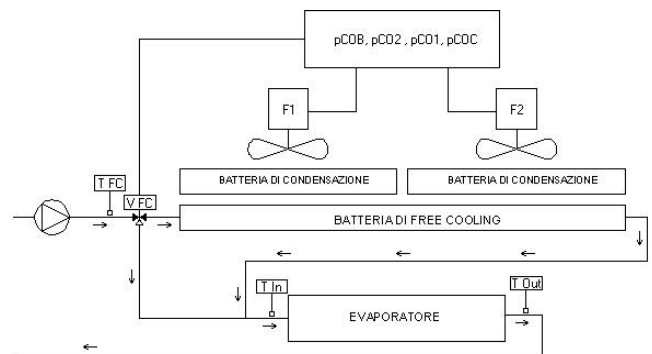

Fig. 18.1 Diagram of units with freecooling control

18.1 Activation of the freecooling function

The freecooling function is based on the relationship that compares the temperature measured by the outside temperature probe, the temperature measured by the temperature probe located at the freecooling coil inlet, and the set freecooling delta.

$$\text{Outside temp.} \leq \text{Freecooling IN temp.} - \text{Freecooling delta}$$

If this condition is true, the freecooling function will be enabled, by activating/deactivating the dedicated devices.

18.2 Freecooling thermostat

The freecooling function uses the control set point calculated (considering any compensation) and the freecooling control differential set. Control is based on the water temperature measured by the probe located at the evaporator outlet, considering the effective cooling contribution of the freecooling exchanger in the different outside temperature conditions. Two different control modes can be selected: proportional, proportional + integral, in the latter case the integral constant will need to be set. The set point for freecooling control will be determined based on the required water temperature. Depending on the type of control adopted for the compressors (inlet – outlet), as the temperature references are different, two distinct control graphs will be identified. In units with outlet control and dead zone, the freecooling control set point will correspond to the compressor control set point.

$$\text{STPFC} = \text{STPM}$$

The proportional control band will be equally distributed on both sides of the set point:

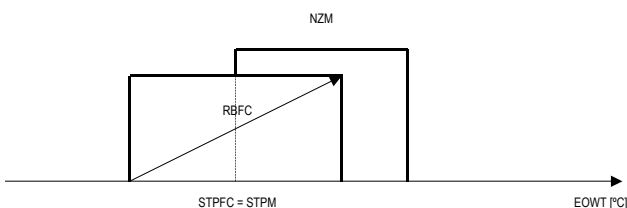

NZM	Dead zone control
RBFC	Freecooling control band
STPFC	Freecooling control set point
STPM	Control set point
EOWT	Evaporator water outlet temperature

Fig. 18.2 Freecooling thermostat with outlet control

In units with inlet control and lateral proportional band, the freecooling control set point will consider an offset compared to the compressor control set point to compensate for the presence of the evaporator coil:

$$STPFC = STPM - OSTPFC$$

The proportional control band will be equally distributed on both sides of the set point

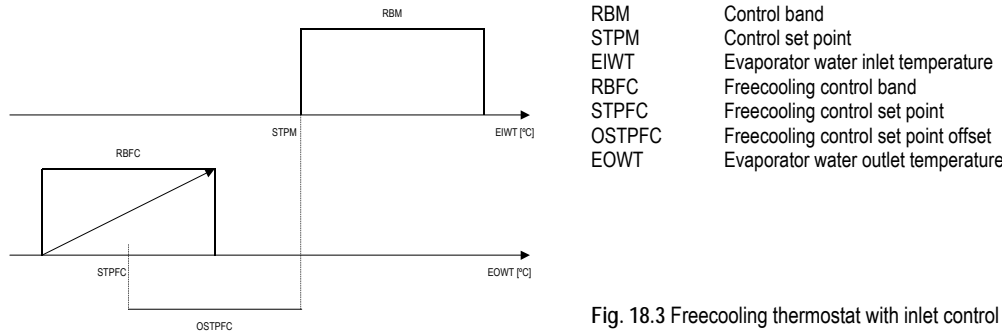

Fig. 18.3 Freecooling thermostat with inlet control

In the freecooling control band, the activation thresholds are calculated for the dedicated devices, such as valves, fans or speed controllers, depending on the mode selected.

As the fans and/or speed controllers are shared between freecooling and condenser control, if one or more compressors belonging to a certain refrigerant circuit are started, priority will be given to condenser control so as to safeguard the circuit.

The freecooling valve will in any case be kept completely open to maximise thermal performance, even with minimum ventilating capacity. So as to optimise the efficiency of the freecooling function during the transients when the unit starts and in stable operation, a bypass time is envisaged for the thermostatic control of the compressors. This time has the task of delaying the start of the compressors so as to allow the freecooling function to reach stable conditions and the bring the efficiency of the unit to the rated value; only after this time, with main thermostat not yet satisfied, will the compressors be started. When the time set is equal to 0, the function will be disabled.

During the operation of the unit, the same parameter is used by the freecooling function to re-evaluate the operating conditions of the unit according to the value measured by the outside temperature probe.

A further temperature delta can be set, which identifies a second threshold; below this value the efficiency of the freecooling coil is considered high enough as to be able to completely satisfy the thermal load of the installation by combined operation of the valve and fans only.

If the compressors are on, the outside temperature falls below the "maximum delta" set, according to the relationship:

$$\text{Outside temp.} \leq \text{Freecooling IN temp.} - \text{"Maximum delta" in freecooling}$$

and the condition remains for a continuous time equal to the compressor bypass time set, the compressors will be stopped and operation will switch to freecooling only so as to satisfy the requirements of the load with the lowest possible energy expense.

Once the bypass time elapses, the thermostatic control of the compressors will re-evaluate the request. An antifreeze threshold is also envisaged, based on the value of the outside air temperature, so as to protect the exchanger during operation in cold environments. If the temperature of the outside air is less than the threshold, the valve that controls the flow of water inside the freecooling exchanger will be opened and the main circulating pump started (if off) to pump the fluid and prevent frost forming in the exchanger. In the case of a 0 to 10 V valve, the percentage of opening will depend on the unit operating status:

- with the unit off the valve will open to 100% of capacity;
- with the unit on the valve will open to 10% of capacity.

In the case of an on/off valve, the valve will always open to the maximum value, irrespective of the unit operating mode.

All the procedures will end as soon as the outside air temperature exceeds a fixed hysteresis of 1.0°C above the set threshold.

18.3 Deactivation of the freecooling function

There are two main reasons for the freecooling valve to close, the first depending on the outside temperature, and the second depending on the desired control temperature. The freecooling valve will be closed if the freecooling conditions are no longer present:

$$\text{Outside temp.} \geq (\text{Freecooling temp.} - (\text{Freecooling delta}) + 1.5^\circ\text{C.}$$

The freecooling valve will be closed if the freecooling thermostat is satisfied.

The reading of the water temperature probe located at the evaporator outlet is controlled for safety reasons. Based on the set thresholds, an antifreeze pre-alarm is managed, which will activate any post-heaters and deactivate the freecooling devices, as well as an antifreeze alarm that shuts down the entire unit. Other system safety devices, such as: serious alarm from digital input, pump thermal cutout, broken control probe, broken antifreeze control probe, evaporator flow switch alarm and the phase monitor alarm, will cause the complete shutdown of the unit, and consequently stop the freecooling function.

18.4 ON/OFF freecooling valve

Proportional control

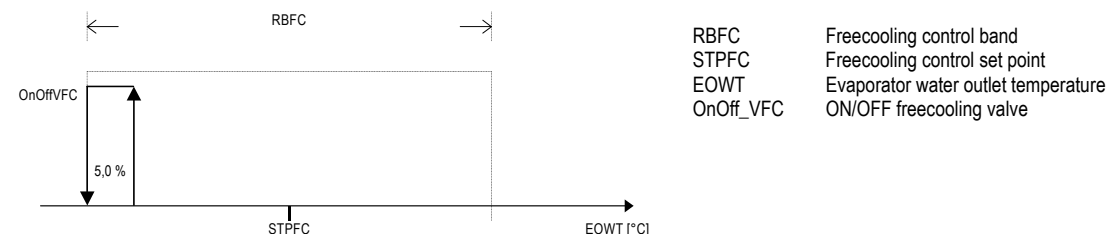

Fig. 18.4 ON/OFF freecooling valve - proportional control

If the temperature conditions allow freecooling control, the ON/OFF freecooling valve will be activated as soon as the temperature exceeds the activation threshold for the step in question by a temperature value equal to:

$$\text{STPFC} - \frac{\text{RBFC}}{2} + 5.0 \% \text{ RBFC}$$

The amplitude of the step is fixed at 5% of the freecooling control differential.

Proportional + integral control

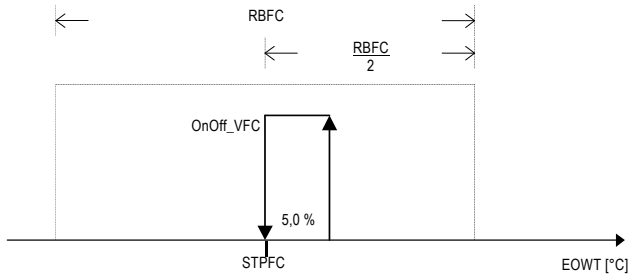

RBFC	Freecooling control band
STPFC	Freecooling control set point
EOWT	Evaporator water outlet temperature
OnOff_VFC	ON/OFF freecooling valve

Fig. 18.5 ON/OFF freecooling valve - proportional + integral control

If the temperature conditions allow freecooling control, the ON/OFF freecooling valve will be activated as soon as the temperature exceeds the activation threshold for the step in question by a temperature value equal to:

$$\text{STPFC} + 5.0 \% \text{ RBFC}$$

The amplitude of the step is fixed at 5% of the freecooling control differential.

18.5 ON/OFF freecooling valve with stepped condenser control

Proportional control

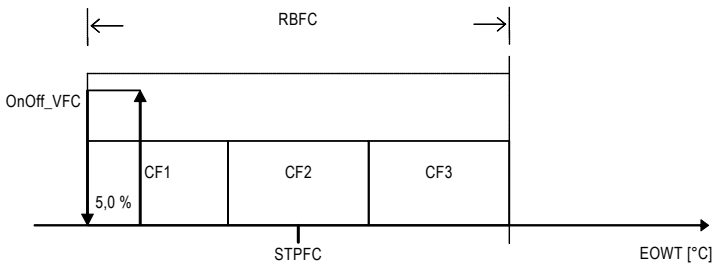

RBFC	Freecooling control band
STPFC	Freecooling control set point
EOWT	Evaporator water outlet temperature
OnOff_VFC	ON/OFF freecooling valve
CF 1...3	Condenser fans

Fig. 18.6 ON/OFF freecooling valve - stepped condenser control - proportional control

Example of freecooling control with ON/OFF valve and three condenser control steps.

The activation step of the ON/OFF valve will in any case be positioned in the first part of the control differential, and its amplitude will be 5% of the differential. The activation steps of the condenser fans will be positioned proportionally inside the freecooling differential. To calculate the amplitude of each step, use the following equation:

$$\text{CFn} = \frac{\text{RBFC}}{(\text{No. of master fans} + \text{Number of fan boards})}$$

It is assumed that all the circuits controlled by the different pCO boards making up the system are equivalent and the same number of devices are controlled.

Proportional + integral control

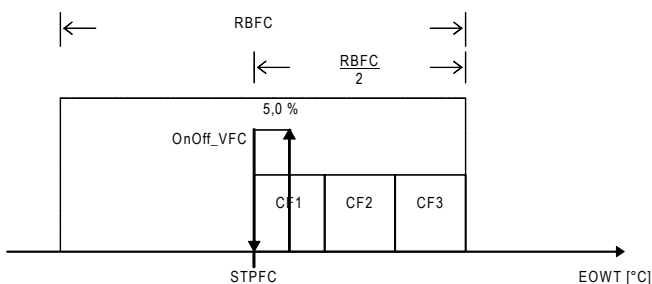

RBFC	Freecooling control band
STPFC	Freecooling control set point
EOWT	Evaporator water outlet temperature
OnOff_VFC	ON/OFF freecooling valve
CF 1...3	Condenser fans

Fig. 18.7 ON/OFF freecooling valve - stepped condenser control - proportional + integral control

Example of freecooling control with ON/OFF valve and three condenser control steps.

The devices, either valves or fans, will be activated in the second half of the control differential, due to the integral control. The activation of the devices will be bound by the integral constant, and will be slower as the value attributed to the specific parameter increases. The amplitude of the valve control step will be equal to 5.0% of the control differential. The amplitude of the fan control steps will be calculated as follows:

$$\text{CFn} = \frac{\text{RBFC}}{(\text{No. of master fans} + \text{Number of fan boards})}$$

It is assumed that all the circuits controlled by the different pCO boards making up the system are equivalent and the same number of devices are controlled.

18.6 ON/OFF freecooling valve with condenser control by inverter

Proportional control

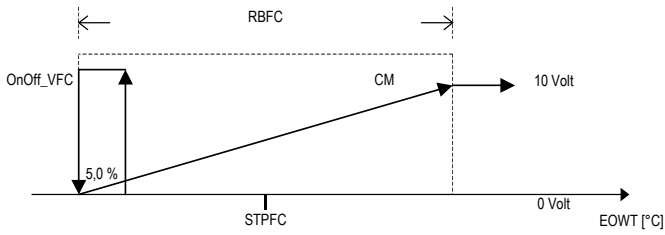

RBFC	Freecooling control band
STPFC	Freecooling control set point
EOWT	Evaporator water outlet temperature
OnOff_VFC	ON/OFF freecooling valve
CM	Modulating condenser control

Fig. 18.8 ON/OFF freecooling valve - proportional condenser control - proportional control

The activation step of the ON/OFF valve will in any case be positioned in the first part of the control differential, and its amplitude will be 5% of the

differential. The proportional ramp for the control of the condenser inverter analogue output will be calculated across the entire control differential; the 0 to 10 Volt value may be limited at the lower end based on the minimum output voltage value set on the screen. All the proportional outputs relating to the different units making up the system are controlled in parallel.

Proportional + integral control

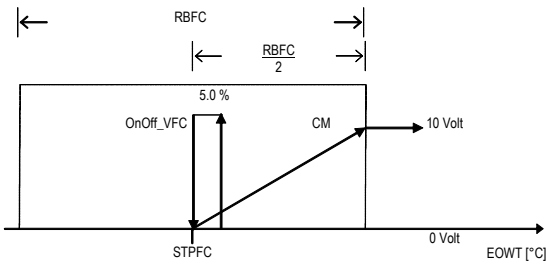

RBFC	Freecooling control band
STPFC	Freecooling control set point
EOWT	Evaporator water outlet temperature
OnOff_VFC	ON/OFF freecooling valve
CM	Modulating condenser control

Fig. 18.9 ON/OFF freecooling valve - proportional condenser control - proportional + integral control

The devices, either valves or fans, will be activated in the second half of the control differential, due to the integral control. The activation of the devices will be bound by the integral constant, and will be slower as the value attributed to the specific parameter increases. The amplitude of the valve control step will be equal to 5.0% of the control differential. All the proportional outputs relating to the different units making up the system are controlled in parallel.

18.7 0 to 10 V freecooling valve

The proportional control of the freecooling valve depends on whether stepped condenser control or a condenser inverter is used. Below are the control diagrams for both situations.

18.8 0 to 10 V freecooling valve with condenser control by steps

Proportional control

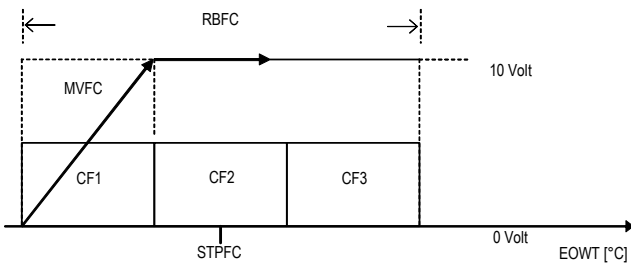

RBFC	Freecooling control band
STPFC	Freecooling control set point
EOWT	Evaporator water outlet temperature
MCFC	Modulating freecooling valve
CF 1...3	Condenser fans

Fig. 18.10 0 to 10 V freecooling valve - stepped condenser control - proportional control

The freecooling valve proportional control ramp is calculated inside the first condenser fan activation step, in this way, when the first fan is started, the valve will be completely open, and thus there will be maximum water flow through the freecooling coil. The activation steps of the condenser fans will be positioned proportionally inside the freecooling differential. To calculate the amplitude of each step, use the following equation:

$$CFn = \frac{RBFC}{(\text{No. of master fans} + \text{Number of fan boards})}$$

It is assumed that all the circuits controlled by the different pCO boards making up the system are equivalent and the same number of devices are controlled.

Proportional + integral control

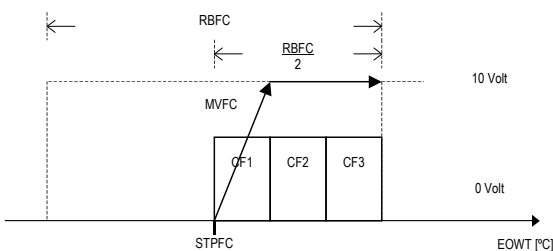

RBFC	Freecooling control band
STPFC	Freecooling control set point
EOWT	Evaporator water outlet temperature
MCFC	Modulating freecooling valve
CF 1...3	Condenser fans

Fig. 18.11 0 to 10 V freecooling valve - stepped condenser control - proportional + integral control

The devices, either valves or fans, will be activated in the second half of the control differential, due to the integral control. The activation of the devices will be bound by the integral constant, and will be slower as the value attributed to the specific parameter increases. The freecooling valve proportional control ramp will be calculated inside the first fan activation step; in this way, when the first fan is started, the valve will be completely open, and thus there will be maximum water flow through the freecooling coil. The activation steps of the fans will be positioned proportionally inside the freecooling differential. To calculate the amplitude of each step, use the following equation:

$$CF_n = \frac{RBFC}{(\text{No. of master fans} + \text{Number of fan boards})}$$

It is assumed that all the circuits controlled by the different pCO boards making up the system are equivalent and the same number of devices are controlled.

18.9 0 to 10 V freecooling valve with condenser control by inverter

Proportional control

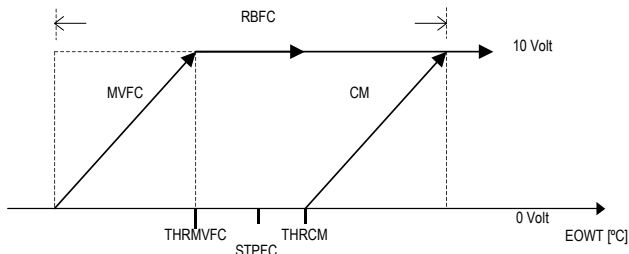

RBFC	Freecooling control band
STPFC	Freecooling control set point
EOWT	Evaporator water outlet temperature
MVFC	Modulating freecooling valve
CM	Modulating condenser control
THRMVFC	Maximum valve opening threshold, percentage
THRCM	Modulating condenser control minimum speed threshold, percentage

Fig. 18.12 0 to 10 V freecooling valve - proportional condenser control - proportional control

The proportional freecooling valve control ramp will be calculated inside the area determined by the thresholds:

$$\text{STPFC} - \text{RBFC} / 2$$

$$\text{STPFC} - \text{RBFC} / 2 + \text{THRMVFC}$$

$$\text{STPFC} - \text{RBFC} / 2 + \text{THRCM}$$

$$\text{STPFC} + \text{RBFC} / 2$$

The start/end points of the two control ramps can be modified as desired by the user, by setting the value of the thresholds (see the graph) expressed as a percentage of the freecooling differential.

For the freecooling valve, the field of setting ranges from 25 to 100% of the differential.

For the condenser inverter, the field of setting ranges from 0 to 75% of the differential.

Example:

Control set point =	12.0 °C
Freecooling differential =	4.0 °C
Freecooling valve threshold % =	40%
Condenser inverter threshold % =	80%
Freecooling valve control proportional area =	10.0T11.6 °C
Control set point - Freecooling differential / 2 =	10.0 °C
Maximum valve opening threshold % =	1.6 °C
Condenser inverter control proportional area =	13.2T16.0 °C
Control set point - Freecooling differential / 2 =	10.0 °C
Control set point - Freecooling differential / 2 + Minimum inverter speed threshold % =	13.2 °C

18.10 Proportional + integral control

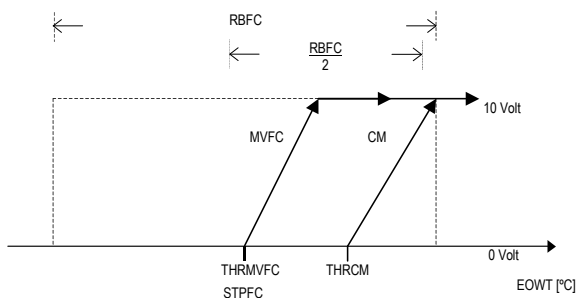

RBFC	Freecooling control band
STPFC	Freecooling control set point
EOWT	Evaporator water outlet temperature
MVFC	Modulating freecooling valve
CM	Modulating condenser control
THRMVFC	Maximum valve opening threshold, percentage
THRCM	Modulating condenser control minimum speed threshold, percentage

Fig. 18.13 0 to 10 V freecooling valve - proportional condenser control - proportional + integral control

The devices, either valves or fans, will be activated in the second half of the control differential, due to the integral control. The activation of the devices will be bound by the integral constant, and will be slower as the value attributed to the specific parameter increases.

19. Antifreeze control

Inputs used:

- Evaporator water outlet temperature

Parameters used:

- Enable evaporator outlet probe
- Antifreeze heater set point
- Antifreeze heater differential
- Antifreeze alarm set point
- Antifreeze alarm differential
- Type of alarm reset
- Alarm signal delay time

Outputs used:

- Antifreeze heater
- General alarm relay
- All the outputs relating to the compressors
- Main circulating pump

Description of operation

Each pCO unit can manage the antifreeze control function, as long as the evaporator water outlet temperature probe is connected and enabled.

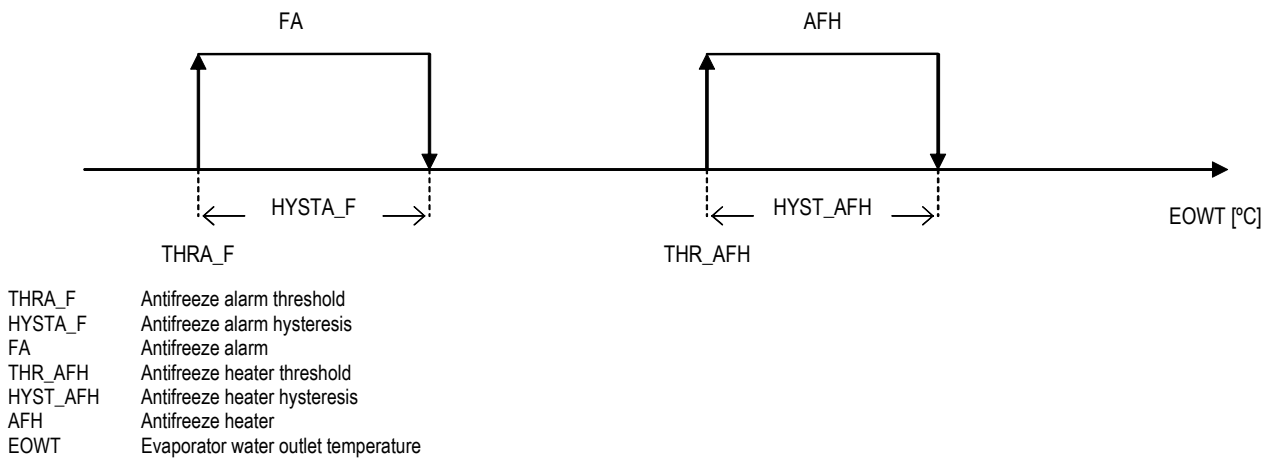

Fig. 19.1 Antifreeze heater control – antifreeze alarm

Antifreeze control is always active, even when the unit is off, in cooling and heating operation.

The antifreeze alarm is a system alarm, and consequently in multi-board systems, when activated on any unit causes the total shutdown of the unit.

The type of alarm reset can be selected, automatic or manual; if automatic reset is selected, the alarm signal will be delayed from the start of the main circulating pump, to give the unit time to pump all the chilled liquid and avoid alarms in the initial start-up phase.

Antifreeze heater

Each circuit features an antifreeze heater to prevent the activation of the alarm and consequently the shutdown of the unit.

This heating element is activated and deactivated depending on a set threshold and hysteresis. The activation of a heating element in any of the circuits causes the shutdown of the active cooling devices, either compressors or freecooling devices.

20. Pump control

20.1 Burst operation

Inputs used

- Temperature control probe

Parameters used

- Enable burst operation
- Burst OFF time
- Burst ON time

Outputs used

- Pump 1
- Pump 2

The management of the main circulating pump allows the possibility of enabling burst operation.

This special operating mode is activated if the circuit is off due to the control set point having been reached, and consequently no compressor is running.

The pump is activated intermittently in ON/OFF cycles according to specific set time intervals.

The user must set the on and off times; the sequence is immediately stopped as soon as a temperature control request arises, causing the normal start-up of the unit, observing the set pump-device delays.

20.2 Pump rotation

Inputs used

- pump alarms

Parameters used

- enable pump 2
- type of pump rotation
- number of hours for pump rotation

Outputs used

- pump 1
- pump 2

The user can decide to use a second pump for the circulation of the water. In this case, pump number two is controlled by slave board no. 1. The two pumps never operate at the same time, and two types of rotation are available:

- based on the number of operating hours
- based on the number of starts.

The pumps are also rotated in the event of flow switch or pump thermal overload alarms.

If an alarm is activated, the procedure will be the following:

assuming that pump 1 is operating, while pump 2 is off.

- pump 1 alarm → pump 1 off, pump 2 on, unit on.

- pump 2 alarm → pump 1 off (from previous alarm), pump 2 off, unit off.

Pump number two is managed by the software as an alternative to the relay for the deactivation of the utilities (see the following paragraph).

21. Installation start-up mode

Inputs used

- Unit ON/OFF

Parameters used

- enable utility deactivation

Outputs used

- deactivate utilities

This function is very useful during the start-up of the installation, when the temperature of the water is very high, and therefore deactivating the utilities (fan coils etc.) will help the water loop reach the operating temperature faster.

This function is managed as an alternative to the second pump.

22. Accessory functions

22.1 Temperature set point compensation

Inputs used

- outside air temperature

Parameters used

- enable compensation
- compensation differential
- start compensation temperature in cooling
- end compensation temperature in cooling
- start compensation temperature in heating
- end compensation temperature in heating

Outputs used

- Control set point

The temperature set point can be automatically “compensated” for reasons of comfort. Imagine, for example, a commercial installation where people frequently enter and exit the premises; if the inside temperature is 10°C lower than the outside temperature, the temperature difference may disturb people and compromise their health. Indeed, for optimum comfort the maximum difference between inside and outside temperature should not exceed 6°C. To overcome this problem, based on the outside temperature, the software will increase or decrease (in cooling and heating operation respectively) the control set point by a certain value so as to compensate for the temperature difference between the outside and inside, as seen in the diagram below:

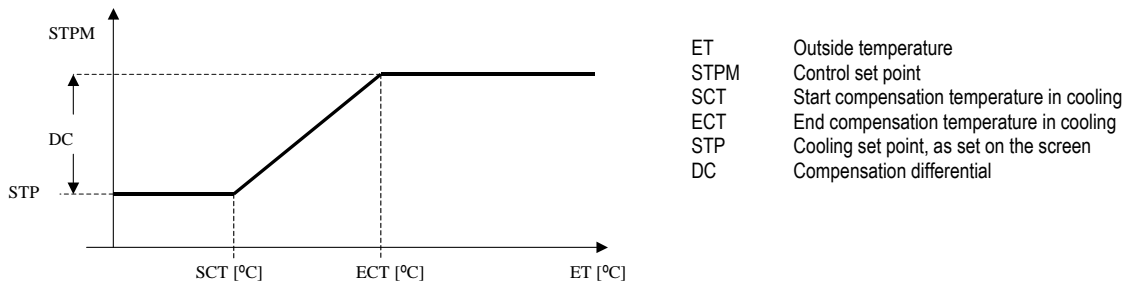

22.2 Time bands

If the system is fitted with the clock (optional on pCO¹, pCO^c and pCO^{xs}, standard on pCO²/pCO³), the time band functions can be enabled.

These screens are only present on the master. Two types of time bands can be managed:

- Unit ON/OFF
- Different set points for different time bands

The two types can be used at the same time.

Time bands with unit ON/OFF

The user can decide to switch the unit off at different times of the day or on different days of the week.

If selecting “F1”, on that day the software will behave as follows:

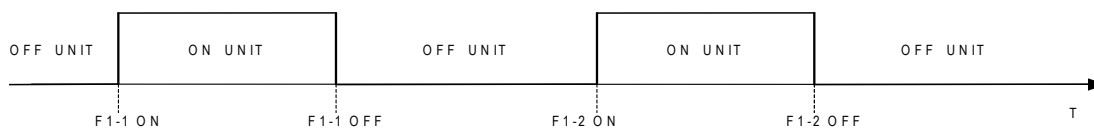

If selecting “F2”, on that day the software will behave as follows:



22.3 Time bands with different set points

Three different set points can be set for the same day, in both cooling and heating modes.

Based on the current time and the time bands, the software will use the correct set point.

Outside of the selected time bands, the software will use the set point defined on screen S1.

In heat recovery mode, the time bands will act on the evaporator set point.

The final set point is in any case always adjusted by the outside compensation function if enabled, and by the outside set point, if set.

23. Alarms

23.1 General description

The alarms are divided into three categories

Signal-only alarms (signal on the display, buzzer, alarm relay)

Circuit alarms (deactivate only the corresponding circuit, signal on the display, buzzer, alarm relay)

Serious alarms (deactivate the entire system, signal on the display, buzzer, alarm relay)

Signal-only alarms

- Unit maintenance alarm
- Compressor maintenance alarm
- Clock board fault or not connected alarm

Circuit alarms

- High pressure switch / transducer alarm
- Low pressure alarm
- Compressor thermal overload alarm
- Oil differential alarm
- Fan thermal overload alarm
- Alarms deriving from the electronic valve driver (see the following paragraph).

Serious alarms

- No water flow alarm
- Evaporator antifreeze alarm
- Serious alarm from digital input
- Pump thermal overload alarm
- Unit disconnected from network alarm

Alarms deriving from the driver

Below is a list of all the alarms relating to the management of the electronic valve driver. The list relates to a single driver, and consequently if a series of drivers are installed, each of these will feature the following alarms:

- probe error (malfunction or breakage of the temperature and/or pressure probe);
- stepper motor error (fault in motor valve connections);
- EEPROM error (EEPROM malfunction in read or write);
- battery error (battery malfunction);
- high pressure at EXV driver (the operating pressure has exceeded the max. MOP threshold);
- low pressure at EXV driver (the operating pressure has exceeded the min. LOP threshold);
- low superheat alarm (superheating alarm);
- valve not closed during shutdown (valve not completely closed after the last blackout);
- high suction temperature alarm (the operating temperature has exceeded the max. threshold);
- standby due to EEPROM/battery charge error or valve open (the system is blocked due to a problem during the start-up of the driver, see the special "ignore" function);
- LAN disconnected (malfunction or fault in the 485 communication between the pCO* and driver).

Alarm screens

The alarms, as well as being signalled on the unit in question, are sent to the other boards in the network.

In this way, the user is always informed on the status of the system as a whole: in pLAN applications with more than one board connected and with a shared terminal, the alarms will be signalled on both boards, but with a different display.

All the screens show:

- Number of the unit being displayed on the shared terminal : "U:x"
- Active alarm code: "Alxxx"
- Alarm description

```

+-----+
|U:1      Al010|
|  Active alarms|
|   unit :    |
|   - 2 - -   |
+-----+

```

```

+-----+
|U:2      Al010|
|  Low pressure|
|  alarm circuit 1|
| (pressure switch)|
+-----+

```

The description of the alarm is specific for the unit that the alarm is active on, while it is general for the other units in the network. In the example, note that for the low pressure alarm on unit 2 (U:2), the specific description is only displayed only on unit 2, while on unit 1 the general screen is displayed, which describes the alarm code and the number of the board the alarm is active on.

Table of alarms

Code	Alarm description	Generated by	Circuit OFF	Cond. OFF	Unit OFF	Category	Reset Auto/Man	Delay	NOTES
AL001	Serious alarm from digital input	DIN			X	Serious	man	/	Can be enabled on both master and slave
AL002	Antifreeze alarm	DIN			X	Serious	settable	settable	Possibility to select the type of reset If automatic reset, settable delay from start of main pump
AL003	Evaporator pump thermal overload	DIN			X	Serious	man	/	Reverse pumps if second pump enabled
AL004	Condenser pump thermal overload	DIN			X	Serious	man	/	
AL005	Evaporator flow switch	DIN			X	Serious	man	Settable	Can be enabled on both master and slave Settable delay at start-up and in steady op.
AL006	Condenser flow switch	DIN			X	Serious	man	Settable	Can be enabled on both master and slave Settable delay at start-up and in steady op.
AL007	Main fan thermal overload	DIN			X	Serious	man	/	
AL008	Evaporator pump 2 thermal overload	Slave 1				Signal	man	/	Reverse pumps
AL010	Low pressure switch circuit 1	DIN	Circ. 1			Circuit	man	Settable	Settable delay at start-up and in steady operation
AL011	Low pressure switch circuit 2	DIN	Circ. 2			Circuit	man	Settable	Settable delay at start-up and in steady operation
AL012	High pressure switch circuit 1	DIN	Circ. 1			Circuit	man	/	
AL013	High pressure switch circuit 2	DIN	Circ. 2			Circuit	man	/	
AL014	Oil differential pressure switch circuit 1	DIN	Circ. 1			Circuit	man	Settable	Settable delay at start-up and in steady op.
AL015	Oil differential pressure switch circuit 2	DIN	Circ. 2			Circuit	man	Settable	Settable delay at start-up and in steady op.
AL016	Compressor 1 thermal overload	DIN	Comp. 1			Circuit	man	/	The numbering of the components (compressors, probes, transducers, circuits.....) is identical for each board. For example, if there is a fifth compressor, there will not be the "Compressor 5 thermal overload" alarm, but rather "Compressor 1 thermal overload" on unit 2 (U:2)
AL017	Compressor 2 thermal overload	DIN	Comp. 2			Circuit	man	/	See note for AL016
AL018	Compressor 3 thermal overload	DIN	Comp. 3			Circuit	man	/	Only with tandem hermetic compressors. (See note for AL016)
AL019	Compressor 4 thermal overload	DIN	Comp. 4			Circuit	man	/	Only with tandem hermetic compressors. (See note for AL016)
AL020	Condenser fan 1 thermal overload	DIN	Circ. 1	X		Circuit	man	/	Stop circuit unless there is another fan and stop condenser for single coils
AL021	Condenser fan 2 thermal overload	DIN	Circ. 2	X		Circuit	man	/	Stop circuit unless there is another fan and stop condenser for single coils
AL022	Condenser fan 3 thermal overload	DIN		X		Circuit	man	/	
AL023	High pressure from transducer circuit 1	AIN	X			Circuit	man	/	See note for AL016
AL024	High pressure from transducer circuit 2	AIN	X			Circuit	man	/	See note for AL016
AL030	Probe B1 fault	AIN				Signal	man	10 s	
AL031	Probe B2 fault	AIN				Signal	man	10 s	
AL032	Probe B3 fault	AIN				Signal	man	10 s	
AL033	Probe B4 fault	AIN			X	Serious	man	10 s	
AL034	Probe B5 fault	AIN			X	Serious	man	10 s	
AL035	Probe B6 fault	AIN				Signal	man	10 s	
AL036	Probe B7 fault	AIN				Signal	man	10 s	
AL037	Probe B8 fault	AIN				Signal	man	10 s	
AL040	Fan/pump maintenance	system				Signal	man	/	
AL041	Compressor 1 maintenance	system				Signal	man..	/	
AL042	Compressor 2 maintenance	system				Signal	man.	/	
AL043	Compressor 3 maintenance	system				Signal	man.	/	
AL044	Compressor 4 maintenance	system				Signal	man.	/	
AL045	Pump 2 maintenance	pLAN				Signal	man.	/	
AL050	Unit 1 offline	pLAN			X	Serious	auto.	60 s/ 30 s	Total shutdown of the devices due to lack of control
AL051	Unit 2 offline	pLAN			X	Serious	auto.	60 s/ 30 s	Shutdown Slave 2
AL052	Unit 3 offline	pLAN			X	Serious	auto.	60 s/ 30 s	Shutdown Slave 3
AL053	Unit 4 offline	pLAN			X	Serious	man.	60 s/ 30 s	Shutdown Slave 4
AL055	32k clock board fault	system			X	Serious	settable	/	Time bands OFF
AL056	Driver 1 circuit 1 Offline	Driver 1	Circ. 1			Circuit	man.	60 s/ 30 s	
AL057	Driver 2 circuit 1 Offline	Driver 2	Circ. 1			Circuit	man.	60 s/ 30 s	
AL058	Driver 1 circuit 2 Offline	Driver 3	Circ. 2			Circuit	man.	60 s/ 30 s	
AL059	Driver 2 circuit 2 Offline	Driver 4	Circ. 2			Circuit	man.	60 s/ 30 s	
AL060	Active alarms on unit: 1-2-3-4					Signal	auto.	/	General alarm screen. In the event of alarms on a certain unit, this is displayed on the other boards indicating the unit where the alarm is active.
AL101	Probe error	Driver 1	Circ. 1			Circuit	man.	/	
AL102	EEPROM error	Driver 1	Circ. 1			Circuit	man.	/	
AL103	Solenoid valve motor error	Driver 1	Circ. 1			Circuit	man.	/	

AL104	Battery error	Driver 1	Circ. 1			Circuit	man.	/	
AL105	High evaporation pressure (MOP)	Driver 1	Circ. 1			Circuit	man.	settable	
AL106	Low evaporation pressure (LOP)	Driver 1	Circ. 1			Circuit	man.	settable	
AL107	Low superheat	Driver 1	Circ. 1			Circuit	man.	settable	
AL108	Valve not closed during shutdown	Driver 1	Circ. 1			Circuit	man.	/	The reset of the unit alarm depends on the reset of the alarm on driver 1 on screen An of the maintenance menu.
AL109	High suction temperature	Driver 1	Circ. 1			Circuit		settable	
AL110	Standby due to EEPROM/battery charge error or valve open	Driver 1	Circ. 1			Circuit	man.	/	The reset of the unit alarm depends on the reset of the alarm on driver 1 on screen An of the maintenance menu.
AL111	Probe error	Driver 2	Circ. 1			Circuit	man.	/	
AL112	EEPROM error	Driver 2	Circ. 1			Circuit	man.	/	
AL113	Solenoid valve motor error	Driver 2	Circ. 1			Circuit	man.	/	
AL114	Battery error	Driver 2	Circ. 1			Circuit	man.	/	
AL115	High evaporation pressure (MOP)	Driver 2	Circ. 1			Circuit	man.	settable	
AL116	Low evaporation pressure (LOP)	Driver 2	Circ. 1			Circuit	man.	settable	
AL117	Low superheat	Driver 2	Circ. 1			Circuit	man.	settable	
AL118	Valve not closed during shutdown	Driver 2	Circ. 1			Circuit	man.	/	The reset of the unit alarm depends on the reset of the alarm on driver 2 on screen An of the maintenance menu.
AL119	High suction temperature	Driver 2	Circ. 1			Circuit		settable	
AL120	Standby due to EEPROM/battery charge error or valve open	Driver 2	Circ. 1			Circuit	man.	/	The reset of the unit alarm depends on the reset of the alarm on driver 2 on screen An of the maintenance menu.
AL121	Probe error	Driver 3	Circ. 2			Circuit	man.	/	
AL122	EEPROM error	Driver 3	Circ. 2			Circuit	man.	/	
AL123	Solenoid valve motor error	Driver 3	Circ. 2			Circuit	man.	/	
AL124	Battery error	Driver 3	Circ. 2			Circuit	man.	/	
AL125	High evaporation pressure (MOP)	Driver 3	Circ. 2			Circuit	man.	settable	
AL126	Low evaporation pressure (LOP)	Driver 3	Circ. 2			Circuit	man.	settable	
AL127	Low superheat	Driver 3	Circ. 2			Circuit	man.	settable	
AL128	Valve not closed during shutdown	Driver 3	Circ. 2			Circuit	man.	/	The reset of the unit alarm depends on the reset of the alarm on driver 3 on screen An of the maintenance menu.
AL129	High suction temperature	Driver 3	Circ. 2			Circuit		settable	
AL130	Standby due to EEPROM/battery charge error or valve open	Driver 3	Circ. 2			Circuit	man.	/	The reset of the unit alarm depends on the reset of the alarm on driver 3 on screen An of the maintenance menu.
AL131	Probe error	Driver 4	Circ. 2			Circuit	man.	/	
AL132	EEPROM error	Driver 4	Circ. 2			Circuit	man.	/	
AL133	Solenoid valve motor error	Driver 4	Circ. 2			Circuit	man.	/	
AL134	Battery error	Driver 4	Circ. 2			Circuit	man.	/	
AL135	High evaporation pressure (MOP)	Driver 4	Circ. 2			Circuit	man.	settable	
AL136	Low evaporation pressure (LOP)	Driver 4	Circ. 2			Circuit	man.	settable	
AL137	Low superheat	Driver 4	Circ. 2			Circuit	man.	settable	
AL138	Valve not closed during shutdown	Driver 4	Circ. 2			Circuit	man.	/	The reset of the unit alarm depends on the reset of the alarm on driver 4 on screen An of the maintenance menu.
AL139	High suction temperature	Driver 4	Circ. 2			Circuit	man.	settable	
AL140	Standby due to EEPROM/battery charge error or valve open	Driver 4	Circ. 2			Circuit		/	The reset of the unit alarm depends on the reset of the alarm on driver 4 on screen An of the maintenance menu.

Table 23.1 Table of alarms

Alarm log

The alarm log is used to save the operating status of the standard chiller when the alarms are generated. Each record saved to the memory represents an event that can be displayed. The log is useful in troubleshooting any faults as it represents a "snapshot" of the installation at the moment the alarm was generated, and may suggest the possible causes and solutions of the faults. The program features two types of log, the BASIC log and the ADVANCED log.

24.1 Basic log

The pCO* boards can save the events in the BASIC log that is always present on the various boards. If the clock board is not fitted (optional on pCO¹, pCO^{XS} and pCO^C, incorporated on pCO²/pCO³), the basic log only displays the alarm code.

A maximum number of 100 events can be saved; on reaching the one hundredth alarm, that is, the last space available in the memory, the next alarm overwrites the oldest alarm (001), which is thus deleted, and so on for the following events. The events saved, available on maintenance screen "Ai" protected by password, can be deleted by the user. The BASIC log screen is accessible by pressing the MAINTENANCE button, and has the following layout:

```
+-----+
|History alarm   046|
|AL103 09:19 19/11/03|
|Set  12.0 Step 01/04|
|T.In 13.0 T.Usc 11.1|
+-----+
```

The following data are saved for each alarm, corresponding to the status of the standard chiller at the moment when the alarm occurred:

- alarm code
- time
- date
- chronological number of the event (0 to 99)
- current set point
- number of steps currently activated (compressors +load steps)
- evaporator inlet temperature
- evaporator outlet temperature

The chronological number of the event indicates the "age" of the event in the list of 100 events available. The alarm number 001 is the first event after the BASIC log was enabled, and therefore the oldest.

If the cursor is moved to the chronological number, the "history" of the alarms can be scrolled using the arrow buttons, from 0 to 100.

For example, from position 001 pressing the down arrow has no effect.

If 15 alarms have been saved and the log is in position 015, pressing the up arrow has no effect.

24.2 Advanced log

The events are saved to the 1MB or 2MB memory expansion, permanently connected to the board. The advantages and characteristics are listed below:

- Log by event: a typical log by event is the alarm log. If an alarm is activated, the alarm can be saved together with other significant values (temperature, pressure, set point, etc.).
- Log by time: a typical log by time is the log of temperature/pressure values. The temperature and pressure values are saved at regular intervals.
- Log of the logs: this saves the last alarms/temperature/pressure values recorded before a serious alarm. Unlike the data saved by the event and time logs, these data are not overwritten when the memory is full.
- Possibility to choose the values to be saved and the saving method at any time. The "WinLoad" program can be used to define the values to be saved and the saving method, using a practical "Wizard". WinLoad does not need the application software "files", as it can directly request the information required from the application software installed on the pCO¹ – pCO² /pCO³.
- 1MB dedicated flash memory. The system saves the data to the 1MB flash memory on the memory expansion (code PCO200MEM0). As an example, 1MB of memory can contain 5000 alarm events with 5 values for each alarm, and save 2 values, for example temperature and pressure, every 5 minutes for 6 months.
- Possibility to define up to 7 different log configurations. Typically each check will have configured a log of alarms, a log of the values of control (temperature/humidity/pressure) and some "log of the logs".
- Lookup the data saved from the LCD terminal (external or built-in) or from a connected PC.
- "Black box" operation. The memory expansion that contains the logs can be removed from the pCO² of the controlled unit and inserted in another pCO² to lookup the data saved. This pCO² does not need to run the same software as the original.
- Reliability of the data saved. The data are saved to FLASH memory that does not require batteries that may discharge. If following a software update the previously saved data are incompatible with the new software, all the data will be deleted (following confirmation).

25. Supervisor

The unit can be interfaced to a local or remote supervisor/telemaintenance system. The accessories available for the pCO* boards include an optional RS485 serial communication board, supplied separately to the pCO* board (for the installation of the optional serial communication boards, refer to the pCO* board installation manual).

The software can manage the following supervision protocols:

- CAREL
- Modbus®
- LonWorks® (using the optional board)
- TREND (using the optional board)
- BACnet™ (using the external gateway)

If the serial communication values, such as the serial address and communication speed, are set correctly, the parameters shown in the following table will be sent by the unit.

The following is a list of the variables that are managed by the supervisor.

Digital variables

Flow	Index	Scr.	Description
OUT	1		Unit ON/OFF. On the master starts all the connected units. On each single slave, enables the unit to start.
OUT	10	I9	Digital output 1
OUT	11	I9	Digital output 2
OUT	12	I9	Digital output 3
OUT	13	Ia	Digital output 4
OUT	14	Ia	Digital output 5
OUT	15	Ia	Digital output 6
OUT	16	Ib	Digital output 7
OUT	17	Ib	Digital output 8
OUT	18	Ib	Digital output 9
OUT	19	Ib	Digital output 10
OUT	20	Ib	Digital output 11
OUT	21	Ib	Digital output 12
OUT	22	Ib	Digital output 13
OUT	23		Enable driver 1
OUT	24		Enable driver 2
OUT	25		Enable driver 3
OUT	26		Enable driver 4
OUT	27		Enable pump 2
OUT	28		Indicates if the unit is the MASTER
OUT	29		Indicates if the unit is a SLAVE
IN/OUT	30	C1	Enable analogue input 1
IN/OUT	31	C1	Enable analogue input 2
IN/OUT	32	C1	Enable analogue input 3
IN/OUT	33	C2	Enable analogue input 4
IN/OUT	34	C2	Enable analogue input 5
IN/OUT	35	C2	Enable analogue input 6
IN/OUT	36	C3	Enable analogue input 7
IN/OUT	37	C3	Enable analogue input 8
IN/OUT	38	C7	Enable management of the fan coils
OUT	39		The board is a pCO1
OUT	40		Main pump (or Main fan)
OUT	41		Condenser pump
IN/OUT	42		ON/OFF from the supervisor
OUT	43		The board is a pCO2
IN/OUT	44		Select chiller/HP mode from supervisor
OUT	45		The board is a pCOC
OUT	46		Enable freecooling based on the configuration
OUT	47		AIR/AIR unit selected: 0=Main_Pump, 1=Main_Fan
OUT	48		WATER/WATER unit selected: enable condenser pump.
OUT	49		Digital input for selecting chiller / HP mode
OUT	50		Enable digital input for selecting chiller / HP mode
OUT	51		Operating mode: 0=chiller, 1=heat pump
OUT	52		The board is a pCOXS
IN/OUT	53	Cq	Select type of condenser: 0=single, 1=double
OUT	54		Not air unit
OUT	55		Status of pump 2
IN/OUT	56	Cp	Select operation, inverter or stepped : 0 = inverter; 1 = stepped
IN/OUT	57		Reset the alarms
IN/OUT	58	Gf	Select type of freecooling valve: On / Off
OUT	59		Select type of freecooling valve: 0 / 10V
IN/OUT	60	G4	Select capacity control logic: 0=normally closed, 1=normally open
IN/OUT	61	Gg	Select 4-way valve logic: 0=normally closed, 1=normally open
OUT	62		Analogue output 1 used as digital input

Flow	Index	Scr.	Description
OUT	63		Analogue output 2 used as digital input
IN/OUT	64	S2	Recovery priority
OUT	65		Unit 1 online
OUT	66		Compressor 3 enabled
OUT	67		Compressor 4 enabled
OUT	68		Compressor 1 enabled
OUT	69		Compressor 2 enabled
OUT	70		General alarm
OUT	71		Antifreeze alarm
OUT	72	AL016	Compressor 1 thermal overload
OUT	73	AL017	Compressor 2 thermal overload
OUT	74	AL018	Compressor 3 thermal overload
OUT	75	AL019	Compressor 4 thermal overload
OUT	76		Condenser flow switch alarm
OUT	77		Evaporator flow switch alarm
OUT	78	AL012	High pressure alarm circuit 1 (pressure switch)
OUT	79	AL013	High pressure alarm circuit 2 (pressure switch)
OUT	80	AL014	Oil differential alarm circuit 1
OUT	81	AL015	Oil differential alarm circuit 2
OUT	82	AL010	Low pressure alarm circuit 1
OUT	83	AL011	Low pressure alarm circuit 2
OUT	84	AL023	High pressure transducer alarm 1
OUT	85	AL024	High pressure transducer alarm 2
OUT	86	AL001	Serious alarm from digital input
OUT	87	AL020	Condenser fan 1 thermal overload alarm
OUT	88	AL021	Condenser fan 2 thermal overload alarm
OUT	89	AL022	Condenser fan 3 thermal overload alarm
OUT	90	AL007	Main fan thermal overload alarm
OUT	91	AL004	Condenser pump thermal overload alarm
OUT	92	AL003	Evaporator pump thermal overload alarm
OUT	93	AL050	Unit 1 disconnected alarm
OUT	94	AL051	Unit 2 disconnected alarm
OUT	95	AL052	Unit 3 disconnected alarm
OUT	96	AL053	Unit 4 disconnected alarm
OUT	97	AL030	Probe B1 broken or disconnected alarm
OUT	98	AL031	Probe B2 broken or disconnected alarm
OUT	99	AL032	Probe B3 broken or disconnected alarm
OUT	100	AL033	Probe B4 broken or disconnected alarm
OUT	101	AL034	Probe B5 broken or disconnected alarm
OUT	102	AL035	Probe B6 broken or disconnected alarm
OUT	103	AL036	Probe B7 broken or disconnected alarm
OUT	104	AL037	Probe B8 broken or disconnected alarm
OUT	105	AL040	Main pump or main fan maintenance alarm.
OUT	106	AL041	Compressor 1 maintenance alarm
OUT	107	AL042	Compressor 2 maintenance alarm
OUT	108	AL043	Compressor 3 maintenance alarm
OUT	109	AL044	Compressor 4 maintenance alarm
OUT	110	AL055	32k clock board broken or not connected alarm
OUT	111		Request step 1
OUT	112		Request step 2
OUT	113		Request step 3
OUT	114		Request step 4
OUT	115		Enable defrost pressure
OUT	116		Not water/water unit
OUT	117		Unit with recovery
OUT	118		Unit without outside set point
OUT	119		Unit with heat pump

Flow	Index	Scr.	Description
OUT	120		Analogue output 1 used
OUT	121		Analogue output 2 used
IN/OUT	122	Pc	Enable set point compensation with outside temperature
IN/OUT	123	Pb	Unit with outside set point
IN/OUT	124	Ah	Enable compressor 1
IN/OUT	125	Ah	Enable compressor 2
IN/OUT	126	Ah	Enable compressor 3
IN/OUT	127	AL101	Enable compressor 4
IN/OUT	128	AL102	Enable compressor 5
IN/OUT	129	AL103	Enable compressor 6
IN/OUT	130	AL104	Enable compressor 7
IN/OUT	131	AL105	Enable compressor 8
OUT	132	AL106	Unit OFF
OUT	133	AL107	Driver 1 circuit 1 Probe error
OUT	134	AL108	Driver 1 circuit 1 EEPROM error
OUT	135	AL109	Driver 1 circuit 1 Solenoid valve motor error
OUT	136	AL110	Driver 1 circuit 1 Battery error
OUT	137	AL111	Driver 1 circuit 1 High evaporation pressure (MOP)
OUT	138	AL112	Driver 1 circuit 1 Low evaporation pressure (LOP)
OUT	139	AL113	Driver 1 circuit 1 Low superheat
OUT	140	AL114	Driver 1 circuit 1 Valve not closed during shutdown
OUT	141	AL115	Driver 1 circuit 1 High suction temperature
OUT	142	AL116	Driver 1 circuit 1 Standby due to EEPROM/battery charge error or valve open
OUT	143	AL117	Driver 2 circuit 1 Probe error
OUT	144	AL118	Driver 2 circuit 1 EEPROM error
OUT	145	AL119	Driver 2 circuit 1 Solenoid valve motor error
OUT	146	AL120	Driver 2 circuit 1 Battery error
OUT	147	AL121	Driver 2 circuit 1 High evaporation pressure (MOP)
OUT	148	AL122	Driver 2 circuit 1 Low evaporation pressure (LOP)
OUT	149	AL123	Driver 2 circuit 1 Low superheat
OUT	150	AL124	Driver 2 circuit 1 Valve not closed during shutdown
OUT	151	AL125	Driver 2 circuit 1 High suction temperature
OUT	152	AL126	Driver 2 circuit 1 Standby due to EEPROM/battery charge error or valve open

Flow	Index	Scr.	Description
OUT	153	AL127	Driver 1 circuit 2 Probe error
OUT	154	AL128	Driver 1 circuit 2 EEPROM error
OUT	155	AL129	Driver 1 circuit 2 Solenoid valve motor error
OUT	156	AL130	Driver 1 circuit 2 Battery error
OUT	157	AL131	Driver 1 circuit 2 High evaporation pressure (MOP)
OUT	158	AL132	Driver 1 circuit 2 Low evaporation pressure (LOP)
OUT	159	AL133	Driver 1 circuit 2 Low superheat
OUT	160	AL134	Driver 1 circuit 2 Valve not closed during shutdown
OUT	161	AL135	Driver 1 circuit 2 High suction temperature
OUT	162	AL136	Driver 1 circuit 2 Standby due to EEPROM/battery charge error or valve open
OUT	163	AL137	Driver 2 circuit 2 Probe error
OUT	164	AL138	Driver 2 circuit 2 EEPROM error
OUT	165	AL139	Driver 2 circuit 2 Solenoid valve motor error
OUT	166	AL140	Driver 2 circuit 2 Battery error
OUT	167	Ah	Driver 2 circuit 2 High evaporation pressure (MOP)
OUT	168	Ah	Driver 2 circuit 2 Low evaporation pressure (LOP)
OUT	169	Ah	Driver 2 circuit 2 Low superheat
OUT	170	Ah	Driver 2 circuit 2 Valve not closed during shutdown
OUT	171	Ah	Driver 2 circuit 2 High suction temperature
OUT	172		Driver 2 circuit 2 Standby due to EEPROM/battery charge error or valve open
OUT	173	AL056	Driver 1 circuit 1 Offline
OUT	174	AL057	Driver 2 circuit 1 Offline
OUT	175	AL058	Driver 1 circuit 2 Offline
OUT	176	AL059	Driver 2 circuit 2 Offline
OUT	177		High pressure prevent circuit 1
OUT	178		High pressure prevent circuit 2
OUT	179		Confirm change time/date
OUT	180		Inlet probe enabled
OUT	181		Outlet probe enabled
OUT	182	M1	Unit in cooling mode
OUT	183	M1	Unit in heating mode
IN/OUT	184	Pf	Select unit changeover mode (Manual/Automatic)

Table 25.1 Digital supervisor variables

Analogue variables

Flow	Index	Scr.	Description
OUT	1	I0	Analogue input 1
OUT	2	I0	Analogue input 2
OUT	3	I1	Analogue input 3
OUT	4	I1	Analogue input 4
OUT	5	I2	Analogue input 5
OUT	6	I2	Analogue input 6
OUT	7	I3	Analogue input 7
OUT	8	I3	Analogue input 8
OUT	9	Ie	Analogue output 1
OUT	10	Ie	Analogue output 2
IN/OUT	11	S1	Cooling set point (evaporator set point)
IN/OUT	12	S1	Heating set point (evaporator set point)
IN/OUT	13		Condenser control set point
IN/OUT	14	S0	current set point
IN/OUT	15	P1	Temperature control band
IN/OUT	16		Minimum freecooling delta
IN/OUT	17		Freecooling differential
IN/OUT	18		Start defrost set point
IN/OUT	19		End defrost set point
IN/OUT	20		Cooling set point lower limit
IN/OUT	21		Cooling set point upper limit
IN/OUT	22		Heating set point lower limit
IN/OUT	23		Heating set point upper limit
IN/OUT	24		Recovery control set point
IN/OUT	25		Recovery control differential

Flow	Index	Scr.	Description
OUT	26		Status of analogue output 1
OUT	27		Status of analogue output 2
OUT	28		Condenser control differential
OUT	29		Current SuperHeat driver 1
OUT	30		Current SuperHeat driver 2
OUT	31		Current SuperHeat driver 3
OUT	32		Current SuperHeat driver 4
OUT	33		Saturation temperature Driver 1
OUT	34		Saturation temperature Driver 2
OUT	35		Saturation temperature Driver 3
OUT	36		Saturation temperature Driver 4
OUT	37		Suction temperature Driver 1
OUT	38		Suction temperature Driver 2
OUT	39		Suction temperature Driver 3
OUT	40		Suction temperature Driver 4
OUT	41		Suction pressure Driver 1
OUT	42		Suction pressure Driver 2
OUT	43		Suction pressure Driver 3
OUT	44		Suction pressure Driver 4
OUT	45		Main inlet temperature
IN/OUT	46		Main outlet temperature
IN/OUT	47	S4	Automatic changeover set point
IN/OUT	48	Pg	Automatic changeover dead zone

Table 25.2 Analogue supervisor variables

Integer variables

Flow	Index	Scr.	Description
OUT	1		STeFA supervisor
OUT	2		STeFA supervisor
OUT	3		STeFA supervisor
OUT	4		STeFA supervisor
OUT	5		STeFA supervisor
OUT	6		STeFA supervisor
OUT	7		STeFA supervisor
OUT	8		STeFA supervisor
OUT	9		STeFA supervisor
OUT	10		Compressor remote control
OUT	11	M1	Recovery mode: 1 = recovery-only 2 = chiller 3 = chiller + recovery 4 = defrost 5 = recovery-only 6 = heat pump
OUT	12	M0	Unit status: 0 = unit active 1 = off from alarm 2 = off from supervisor 3 = off from time bands 4 = off from digital input (DIN3) 5 = off from local control (terminal keypad) 6 = manual operation
IN/OUT	13	Cp	Fan control: 0 = none 1 = pressure 2 = temperature
OUT	20	A3	Main pump operating hour count (high byte)
OUT	21	A3	Main pump operating hour count (low byte)
OUT	22	A4	Compressor 1 operating hour count (high byte)
OUT	23	A4	Compressor 1 operating hour count (low byte)
OUT	24	A4	Compressor 2 operating hour count (high byte)
OUT	25	A4	Compressor 2 operating hour count (low byte)
OUT	26	A5	Compressor 3 operating hour count (high byte)
OUT	27	A5	Compressor 3 operating hour count (low byte)
OUT	28	A5	Compressor 4 operating hour count (high byte)
OUT	29	A5	Compressor 3 operating hour count (low byte)
OUT	30		Device configuration for all units: 0 = CCCC, 1 = CPCP, 2 = CPPP [C = compressor; P = part load]
IN/OUT	31	C0	Select type of unit: 0 to 23 (see manual)
OUT	32		Type of circuit (physical) = 0 = water / air, 1 = air /air, 2 = water / water
IN/OUT	33	C4	Total number of compressors on the unit
IN/OUT	34	C4	Number of compressors per unit (same for all units)
IN/OUT	35	C4	Number of load steps per compressor (same for all units)
IN/OUT	36		Number of condenser fans (1-3 with single condenser, 1-2 with double condenser)
OUT	37		Inverter speed circuit 1
OUT	38		Inverter speed circuit 2
OUT	39		Opening of freecooling valve
OUT	40		Status of analogue output 1
OUT	41		Status of analogue output 2
IN/OUT	42	Q0	Type of defrost: 0 = Temperature, 1 = Pressure, 2 = Pressure switch
IN/OUT	43	Q2	Delay time at start of defrost
IN/OUT	44	Q2	Maximum defrost duration
IN/OUT	45	Q3	Enable force compressors off when the defrost starts or ends

Flow	Index	Scr.	Description
OUT	46		pLAN address
IN/OUT	47	C5	Driver number
IN/OUT	48	B2	SuperHeat set point for driver 1 circuit 1 in chiller operation
IN/OUT	50	B8	SuperHeat set point for driver 1 circuit 2 in chiller operation
IN/OUT	52	f8	SuperHeat set point for driver 1 circuit 1 in heat pump operation
IN/OUT	53	J2	SuperHeat set point for driver 2 circuit 1 in heat pump operation
IN/OUT	54	B5	SuperHeat set point for driver 1 circuit 2 in heat pump operation
IN/OUT	55	F5	SuperHeat set point for driver 2 circuit 2 in heat pump operation
IN/OUT	56	L4	SuperHeat set point for driver 1 circuit 1 in defrost operation
IN/OUT	58	L6	SuperHeat set point for driver 1 circuit 2 in defrost operation
IN/OUT	60	L5	MOP limit in chiller operation
IN/OUT	61	L2	LOP limit in chiller operation
IN/OUT	62		MOP limit in defrost operation
IN/OUT	63		LOP limit in defrost operation
IN/OUT	64		MOP limit in heat pump operation
IN/OUT	65		LOP limit in heat pump operation
IN/OUT	66		Set minutes
IN/OUT	67		Set hour
OUT	68		Current minutes
OUT	69		Current hour
OUT	70		Type of probe connected to analogue input 1
OUT	71		Type of probe connected to analogue input 2
OUT	72		Type of probe connected to analogue input 3
OUT	73		Type of probe connected to analogue input 4
OUT	74		Type of probe connected to analogue input 5
OUT	75		Type of probe connected to analogue input 6
OUT	76		Type of probe connected to analogue input 7
OUT	77		Type of probe connected to analogue input 8
OUT	78		Total steps of the unit
OUT	79		Active step on the unit
OUT	80		Current valve position for driver 1 circuit 1
OUT	81		Current valve position for driver 2 circuit 1
OUT	82		Current valve position for driver 1 circuit 2
OUT	83		Current valve position for driver 2 circuit 2
OUT	84	M1	6 = n.c. 7 = Recovery 8 = Utility 9 = Rec+Utility 10 = Defrost 11 = Rec+Heat 12 = Utility+Heat
OUT	85	M1	Unit operating status : 0 = Defrost compressor 1 1 = Defrost compressor 2 2 = Defrost compressors 1 and 2 3 = PumpDown
OUT	86		Software version

Table 25.3 Integer supervisor variables

Key :

OUT Output variable pCO → Supervisor
 IN/OUT Input/output variable pCO ←→ Supervisor

26. Other protocols

26.1 RS232 protocol (connection via analogue modem)

The user can install an analogue modem to interface the pCO* peripheral to a remote supervisor, without requiring a gateway. The protocol allows the pCO* board to be managed by the remote supervisor as a network node with a single Slave unit connected.

26.2 GSM protocol

Selecting the GSM protocol allows SMS messages to be sent to and received from GSM telephones. In fact, using a GSM modem the pCO* boards send an SMS message to the selected telephone in the event of alarms, and can receive messages from the telephone at any time. The user can in fact modify all the read-write parameters available to the supervisor (see the table of Supervisor variables).

The message received by the user contains:

- the name of the application
- the number of the unit sending the message
- a short text that can be customised by the user
- alarm code
- time
- date
- chronological number of the event (0 to 99)
- current set point
- number of steps currently activated (compressors + load steps)
- evaporator inlet temperature
- evaporator outlet temperature

The GSM modem can be connected to board number 1 only or alternatively to each pCO* board

For the syntax of the SMS message sent to the pCO* and the use of the above table, refer to the manual: *GSM modem protocol for pCO2 (code+030220330)*.

N.B. When the GSM protocol is active, no calls can be made from the remote supervisor to the pCO* board.

CAREL reserves the right to modify or change its products without prior warning.

CAREL

CAREL S.p.A.
Via dell'Industria, 11 - 35020 Brugine - Padova (Italy)
Tel. (+39) 049.9716611 Fax (+39) 049.9716600
<http://www.carel.com> - e-mail: carel@carel.com

Agency