

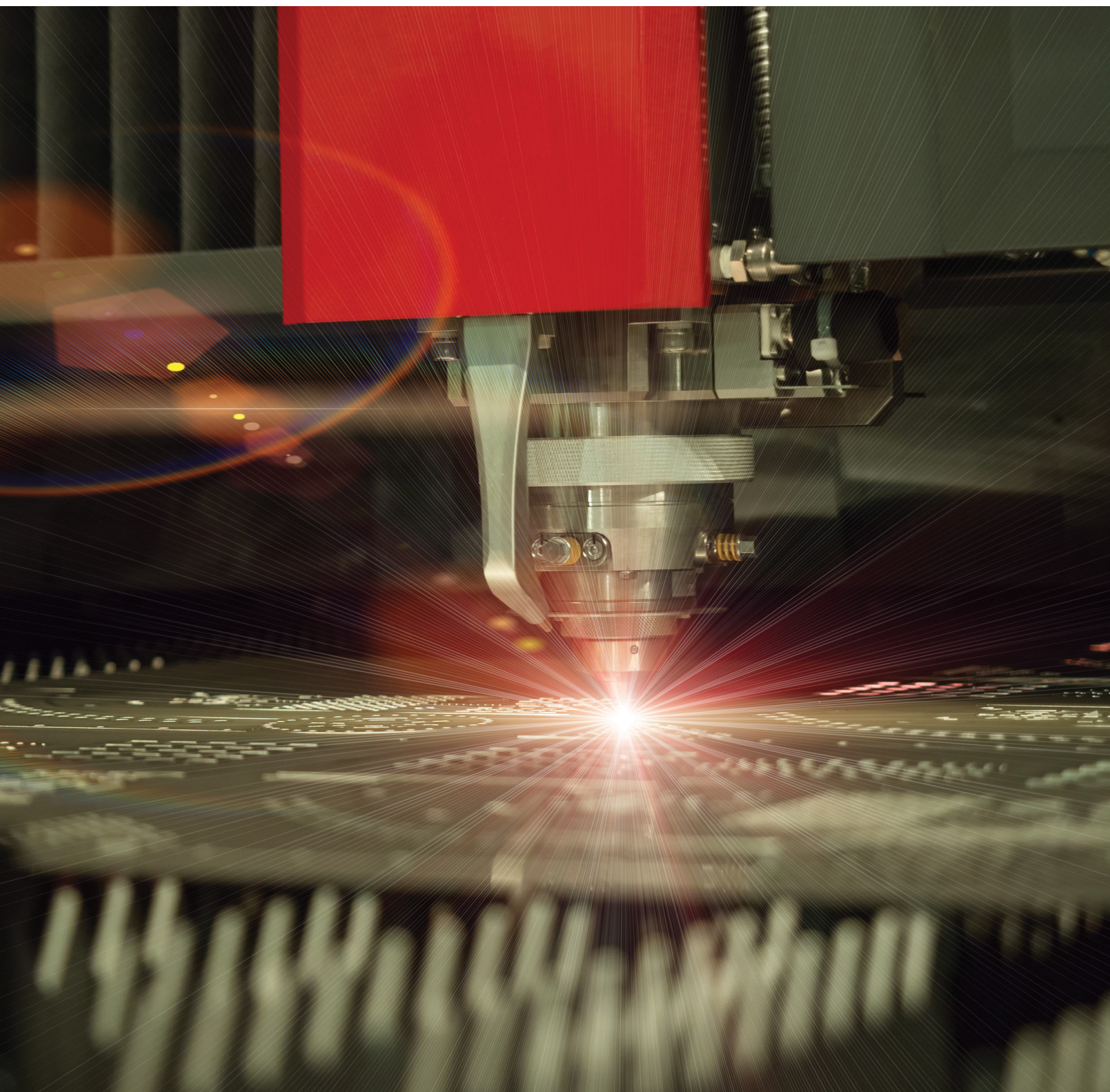

2019 catalog

For CO₂ and fiber laser consumables

Replacement parts suitable for Amada®



Centricut delivers

- OEM quality nozzles, ceramics and optics
- Technical and application support from our OEM-trained technicians
- 100% satisfaction guarantee

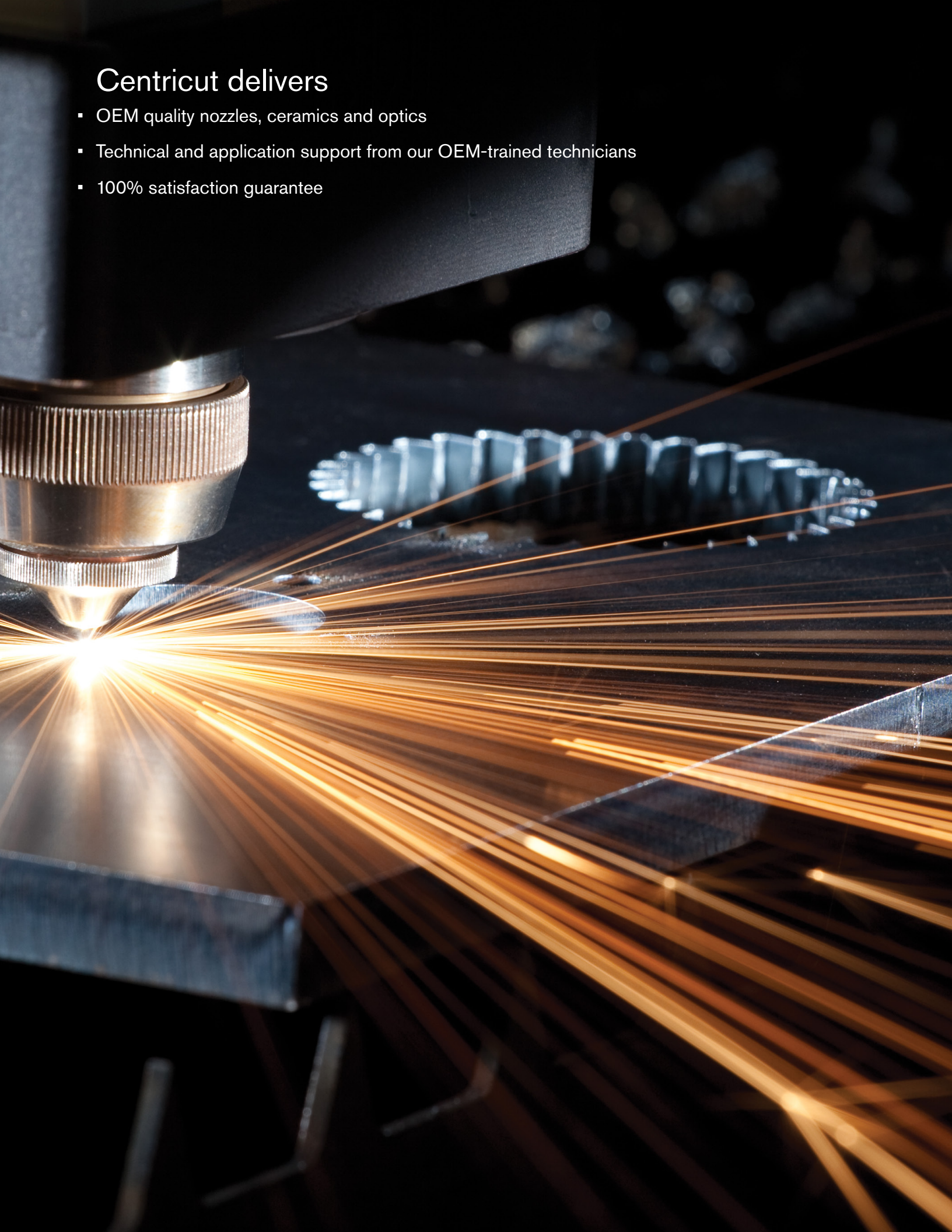

CO₂ and fiber laser nozzles

Nozzle options

All Centricut nozzles are engineered and manufactured to the highest standards. Select the OEM quality nozzle best suited for your application needs

Copper

Most commonly used nozzle offering good durability and nozzle life. Primary nozzle type for fiber lasers.

Chrome plated

Shiny, mirror-like finish provides increased spatter resistance, improved durability and longer life than copper nozzles. Not recommended for use on fiber lasers.

Look for CP in the part number to identify a chrome plated nozzle

Hard chrome plated

Premium nozzles offering the highest level of durability and longest nozzle life. These nozzles are not as shiny as chrome plated and have a dull appearance. Not recommended for use on fiber lasers.

Look for HCP in the part number to identify a hard chrome nozzle.

CP (chrome plated)	Nozzles plated with chrome for increased durability. These nozzles are easier to clean, resist damage due to 'tip-ups' and have better spatter resistance over non-plated nozzles. For use in all laser cutting applications.
Conical	Conical internal geometry for high pressure, non-ferrous cutting applications using nitrogen, air or argon.
Cylindrical	Cylindrical internal geometry for low pressure, mild steel cutting applications using oxygen.
Double	Insert pressed into a standard cylindrical nozzle for improved edge quality, laminar gas flow and spatter resistance. Primarily used in mild steel applications.
HCP (hard chrome plated)	Enhanced durability chrome plated nozzles. These nozzles are easier to clean, resist damage due to 'tip-ups' and have better spatter resistance over non-plated nozzles. For use in all laser cutting applications.
HP (high pressure) HD (high density)	Conical style nozzle for high pressure, non-ferrous cutting applications using nitrogen, air or argon.
Inner	Also referred to as a 'nozzle insert'. Works in conjunction with an outer nozzle to create a double nozzle. Primarily used in mild steel applications.
Low pressure	Cylindrical style nozzle for low pressure, mild steel cutting applications using oxygen.
Outer	Works in conjunction with an inner nozzle to create a double nozzle. Primarily used in mild steel applications.
Shower	Nozzles with a center orifice surrounded by smaller jets. The smaller jets focus the assist gas into the kerf, creating improved edge quality and the ability to cut thicker material. Primarily used in mild steel applications.

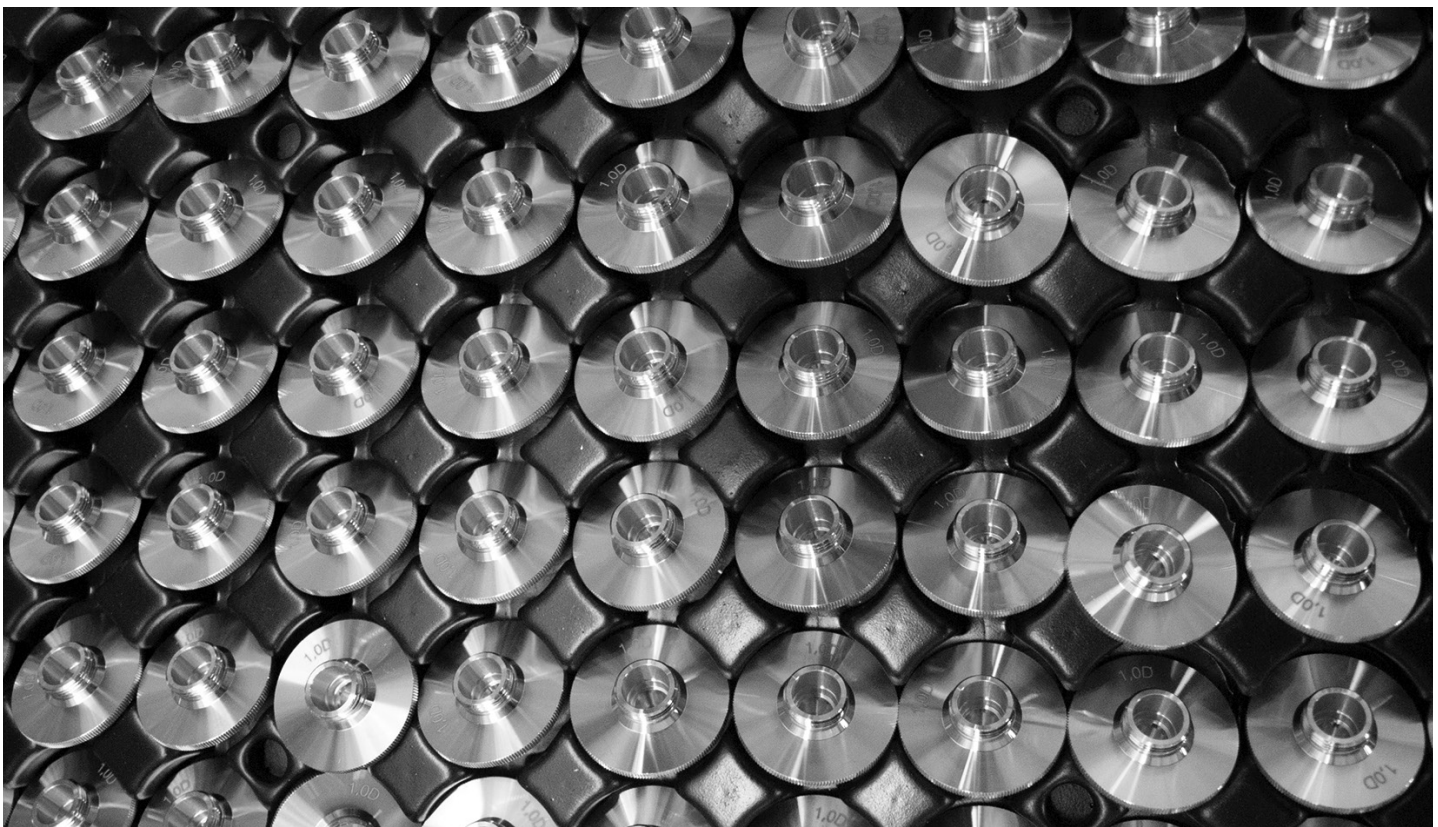

CO₂ and fiber laser optics

Optics key

Lens	
MEN	Meniscus
PLX	Plano-convex
MTD	Mounted
Not MTD	Not mounted
PO	Plano
MP5 or ULA	Ultra low absorption
AR	Anti-reflection
ZNSE	Sinc-selenide
FS	Fused silica
DIA	Diameter
FL	Focal length
ET	Edge thickness
WD	Working distance

How to handle optics

Follow these easy steps, when cleaning or changing your optic, to help maximize the life and performance of your lens

- Avoid touching coated surfaces of the lens and hold the optic by its sides
- Wear powder-free finger cots or latex gloves when handling
- Do not use any tools or sharp objects when handling the optic or when removing it from its packaging
- Ensure the work surface is clean and free of oils, grease and dirt
- Do not place the optic on hard surfaces as they scratch easily
- Once the optic has been unpacked, carefully place it on the lens tissue in which it was originally wrapped

Optics disposal

It is important to dispose of used laser optics at a licensed industrial waste facility which is in compliance with all local, state, and federal regulations. If you don't have access to a licensed industrial waste facility, and purchased your laser optics through Centricut, you may return them to Centricut for proper disposal. This service is only available to Centricut customers.

All optics returned to Centricut must:

- Include return authorization and invoice numbers
- Be sealed in a plastic bag to minimize any hazards
- Remove excess ZnSe powder prior to sealing

*Acceptance of goods will be refused if not packaged correctly or if the return authorization number isn't included



Centricut part number	Reference number	Type	Material	Diameter	Focal length	Edge thickness
Fiber laser lens						
NT375-7955		PLX	FS	30 mm	123 mm	3.82 mm
TR300-9799		PLX	FS	30 mm	146 mm	8.0 mm
TR300-3107		PLX	FS	40 mm	150 mm	8.0 mm
AM313-0238	7710238, 71565737	PLX	FS	50.8 mm	190 mm	11.4 mm
SA384-0022	316-301-0022, 970128	PLX	FS	25.4 mm	200 mm	6.35 mm
SA384-0026	316-301-0026, ESTFLO2119	PLX	FS	38.1 mm	210 mm	6.35 mm
PR361-8988NM	968988, 344631	PLX	FS	1.5"	5.0"	.280"
PR361-2284	968987, 470321	PLX	FS	1.5"	7.5"	0.28
MB312-8858		PLX	FS	2.0"	7.5"	.45"
PR361-0773	970773/M15-15-B X-SP-7MM	PLX MTD	FS	1.5"	5.0"	.275"
PR361-8988	LH968988PVL, 576.41.005	PLX MTD	FS	1.5"	5.0"	.280"

Centricut part number	Reference number	Material	Diameter	Edge thickness
Fiber laser windows				
PT317-1424	P0588-1022-00001	FS	21.5 mm	2.0 mm
PT317-0589	970397, 6930003260, P0589-360-00002, R26RT006410, R26ZZC90110	FS	22.35 mm	4.0 mm
PT317-9360	6930003260, P0589-360-00001	FS	22.35 mm	4.0 mm
MB312-2336		FS	25.4 mm	4.0 mm
PT317-0010	P0253-1034-00001	FS	30.0 mm	1.5 mm
TR300-6719	766719, P0795-1201-00002	FS	30.0 mm	5.0 mm
SA384-0007	316-304-0007, ESTFLO01407, 632755-117	FS	32.0 mm	6.35 mm
TR300-4767	1614767	FS	34.0 mm	4.9 mm
PR361-0089	1057.81000.089	FS	35.0 mm	1.5 mm
BY314-5746	968752, 10045746, 10-02-01-5511	QTZ	36.0 mm	5.0 mm
PR361-0474	970474	FS	37.0 mm	4.0 mm
PT317-1551	P0595-61551, P0595-58601-61551	FS	37.0 mm	7.0 mm
PT317-1425		FS	38.0 mm	5.2 mm
CN307-3987	913987, 71598028	FS	38.1 mm	1.6 mm
MZ315-5350	Z50SA015350, W495	FS	42.0 mm	9.0 mm
PT317-5919	77005919	FS	48.0 mm	7.0 mm
PT347-0000	OG Y D50 d2 HII	FS	50.0 mm	2.0 mm
PT317-1789	284.0402, 971789, 717062	FS	50.0 mm	3.18 mm
MB312-0137	633744-137	FS	50.0 mm	8.0 mm
AM313-0026	71570026	FS	OCTAGONAL	1.5 mm

Centricut is not affiliated with the named manufacturers. Reference to machines, parts, descriptions, and model numbers are for convenience in verifying compatibility only. All parts are made by or for Centricut and are not made by the referenced manufacturers (unless expressly indicated). Centricut is a registered trademark of Hypertherm, Inc. All other trademarks are the properties of their respective owners.

Centricut part number	Reference number	Type	Material	Diameter	Focal length	Edge thickness
CO ₂ lenses						
LL342-1819	166634, 61819	MEN	ZNSE	1.1"	5.0"	.236"
TR300-0163	350163, 861143, LMZ1.5-0.29-10.00-2048	MEN	ZNSE	1.5"	10.0"	.290"
TR300-6477	726477	MEN	ZNSE	1.5"	10.0"	.354"
BY314-0185	4-00185, 4-00372, 142375, 60603	MEN	ZNSE	1.5"	3.75"	.236"
TR300-6104	346104, 61962, 831393	MEN	ZNSE	1.5"	3.75"	.290"
BY314-0736	414323, 4-10736	MEN	ZNSE	1.5"	3.75"	.354"
BY314-0186	60260, 507790, 4-00186, 110111	MEN	ZNSE	1.5"	5.0"	.236"
TR300-8114	088114, 60696, 406294, 110109, 61014, 658108, 29100023, 6930001002	MEN	ZNSE	1.5"	5.0"	.290"
BY314-5094	767963, 60615, 4-05094, 110113, 358186, 62710	MEN	ZNSE	1.5"	5.0"	.354"
PR361-0004	62709, 621644, 120216	MEN	ZNSE	1.5"	5.0"	.354"
PT317-0001	61851, 312370	MEN	ZNSE	1.5"	7.5"	.125"
BY314-0187	784964, 60602, 4-00187, 110112	MEN	ZNSE	1.5"	7.5"	.236"
TR300-7517	097517, 60697, 702232, 110110, 61983	MEN	ZNSE	1.5"	7.5"	.290"
LL342-1171	61171	MEN	ZNSE	1.5"	7.5"	.310"
BY314-5095	60616, 4-05095, 570721, 110114, 361129	MEN	ZNSE	1.5"	7.5"	.354"
BY314-8637	698637	MEN	ZNSE	1.5"	7.5"	.354"
TR300-1972	61961, 141972, 977976	MEN	ZNSE	1.5"	8.85"	.290"
TR300-8123	518123	MEN	ZNSE	1.575"	6.102"	.295"
LV333-0176	480176, 29100115	MEN	ZNSE	1.75"	5.0"	.354"
LV333-1551	981551, LMZ2.0-0.380-10.0-2053, 29100061S	MEN	ZNSE	2.0"	10.0"	.380"
PT317-6326	206326	MEN	ZNSE	2.0"	5.0"	.378"
LV333-1004	458138, LMZ2.0-0.380-5.00-2051, PLLMZ0024, 29100154	MEN	ZNSE	2.0"	5.0"	.380"
CN307-2376	61405, 695399, 922376, 232771, 60698, 29100055	MEN	ZNSE	2.0"	7.5"	.380"
AM313-0305	61161, 81140305, LPCZ-1.10-0.16-5.0-1044, PLLPZ0132, 561067	PLX	ZNSE	1.1"	5.0"	.160"
AM313-6602	726602	PLX	ZNSE	1.1"	7.5"	.160"
AM313-0657	600657, 71502030, LPCZ-1.5-0.30-10.0-1128	PLX	ZNSE	1.5"	10.0"	.300"
TK374-2235	312235	PLX	ZNSE	1.5"	12.5"	.300"
PT317-8950	148950	PLX	ZNSE	1.5"	2.5"	.085"
MZ315-0130	60830, Z50MB000130, 962834, 766479	PLX	ZNSE	1.5"	5.0"	.118"
TR300-0002	61163, LMZ1.5-0.16-5.00-2043, 706491, 907557, PLCZ-1.5-0.16-5.0-1116	PLX	ZNSE	1.5"	5.0"	.160"
MZ315-0160	60770, 227092, Z50MB000130H, LPCZ-1.5-0.236-5.0-1122, 834-319-002	PLX	ZNSE	1.5"	5.0"	.236"
PR361-9011	834-319-011, 60905, 658108, ZC15500300, Z50MB000400, 578662, MLL00016	PLX	ZNSE	1.5"	5.0"	.300"
MB312-500	W500, 60905, 110144, LPCZ-1.5-0.30-5.0-1125, PLLPZ0132	PLX	ZNSE	1.5"	5.0"	.310"
CN307-8085	941031, 61001, 908085, ZC15513280, 110092, PLLPZ0033	PLX	ZNSE	1.5"	5.0"WD	.280"
PR361-0003	60784, LPCZ-1.5-0.236-7.5-1123	PLX	ZNSE	1.5"	7.5"	.236"
PR361-9012	834-319-012, 60906, 618938, 306068, 741363, 60882, 299133, 71501070NM, 62649	PLX	ZNSE	1.5"	7.5"	.300"
MB312-018	60906, W018, 383862, 60906LA, W018, 62649ULA, 383862, 62649LA	PLX	ZNSE	1.5"	7.5"	.310"
CN307-9484	909484, 61002, 464497, 100096, LPCZ-1.5-0.280-5.13-1007, PLLPZ0052	PLX	ZNSE	1.5"	7.5"WD	.280"
PT317-8275	628275, W502A, 630736-117	PLX	ZNSE	2.0"	10.0"	.310"
PT317-0537	960537	PLX	ZNSE	2.0"	10.0"	.380"
CN307-4498	154498, 926274	PLX	ZNSE	2.0"	10.0"WD	.380"
TK374-7338	197338	PLX	ZNSE	2.0"	11.25"	.310"
MZ315-5980	145980	PLX	ZNSE	2.0"	5.0"	.300"
MB312-505	W505, 110169, PLLPZ0162, 304725, 61003, Z50ZZ005160	PLX	ZNSE	2.0"	5.0"	.310"
MZ315-0516A	61019, Z50ZZ00516A, Z50ZZ013480, 81140307, 741363	PLX	ZNSE	2.0"	5.0"	.380"

Centricut is not affiliated with the named manufacturers. Reference to machines, parts, descriptions, and model numbers are for convenience in verifying compatibility only. All parts are made by or for Centricut and are not made by the referenced manufacturers (unless expressly indicated). Centricut is a registered trademark of Hypertherm, Inc. All other trademarks are the properties of their respective owners.

Centricut part number	Reference number	Type	Material	Diameter	Focal length	Edge thickness
CO ₂ lenses (continued)						
CN307-0676	870676, 61514, LPCZ-2.0-0.38-5.19-1141, PLLPZ0116	PLX	ZNSE	2.0"	5.0"WD	.380"
NT375-4494	634494, LPCZ-2.0-0.30-7.5-1133	PLX	ZNSE	2.0"	7.5"	.300"
MB312-510	W510, 61004, 892020, 110122, PLLPZ0138	PLX	ZNSE	2.0"	7.5"	.310"
MZ315-0520A	61405, 232771, Z50ZZ00520A, MLL00018, Z50ZZ005200, Z50ZZ013470, 81140186	PLX	ZNSE	2.0"	7.5"	.380"
CN307-1603	61515, 781603, LPCZ-2.0-0.38-7.67-1143, PLLPZ0115	PLX	ZNSE	2.0"	7.5" WD	.380"
TK374-3478	541344, 263478, Z50ZZ00530A, LPCZ-2.0-0.31-7.45-1137	PLX	ZNSE	2.0"	8.75"	.310"
TK374-6670	236670, 61690, Z50ZZ00550A	PLX	ZNSE	2.5"	10.0"	.390"
TK374-1592	178937	PLX	ZNSE	2.5"	11.25"	.310"
TK374-8593	828593	PLX	ZNSE	2.5"	12.5"	.390"
TK374-3827	243827, Z50ZZ00540A, LPCZ-2.5-0.31-8.75-1145	PLX	ZNSE	2.5"	8.75"	.310"
AM313-0221	81140221, 6067639	PLX MTD	ZNSE	1.5"	3.75"	.300"
AM313-0306	81140306, 65024, 578662/M16-15-1C-P5.0, PLLPZ0133, 6874793	PLX MTD	ZNSE	1.5"	5.0"	.300"
AM313-1216	578662/M20-15-1C-P5.0, 9001216A, 71501072, 7973109, 6360374	PLX MTD	ZNSE	1.5"	5.0"	.300"
AM313-8662	578662/M21-15-1C-P5.0, 6060415	PLX MTD	ZNSE	1.5"	5.0"	.300"
AM313-9830	65101, 578662, 6547252	PLX MTD	ZNSE	1.5"	5.0"	.300"
AM313-1215	9001215A, 306068/M21-15-1C-P7.5, 7973110, 71501070, 6395647	PLX MTD	ZNSE	1.5"	7.5"	.300"
AM313-9831	71369831, 65102, 6550214	PLX MTD	ZNSE	1.5"	7.5"	.300"
AM313-10F1	680154-001, 71710061, 6021844	PLX MTD	ZNSE	2.0"	10.0"	.380"
AM313-0307	65035, 81140307, 741363, 6068456	PLX MTD	ZNSE	2.0"	5.0"	.380"
AM313-50F1	71710059, 741363M30-20-1C-P5.0, 6296946	PLX MTD	ZNSE	2.0"	5.0"	.380"
AM313-0400	306068, 65025, 81140400, 6022704	PLX MTD	ZNSE	2.0"	7.5"	.300"
AM313-0186	65038, 81140186, PLLPZ0156, 6068413	PLX MTD	ZNSE	2.0"	7.5"	.380"
AM313-75F1	232771M31-20-1C-P7.5, 71710030, 6243925	PLX MTD	ZNSE	2.0"	7.5"	.380"
BY314-7014MP5	460386, 4-07014	MEN	ZNSE MP5	1.5"	10.0"	.354"
BY314-0186MP5	4-00186, 528717, 60260LA	MEN	ZNSE MP5	1.5"	5.0"	.236"
TR300-8114MP5	60696LA, 312503, 29100023, 88114, PLLPZ0125B	MEN	ZNSE MP5	1.5"	5.0"	.290"
BY314-5094MP5	123397, 4-07475, 60615LA, LMZ1.5-0.354-5.0-2008	MEN	ZNSE MP5	1.5"	5.0"	.354"
BY314-0187MP5	714512, 60602LA, 4-00187	MEN	ZNSE MP5	1.5"	7.5"	.236"
TR300-7517MP5	60697LA, 97517, 474644, PLLPZ0126B	MEN	ZNSE MP5	1.5"	7.5"	.290"
BY314-5095MP5	602033, 60616LA, 4-07476, LMZ1.5-0.354-7.5-2009, PLLPZ0130B, 62710	MEN	ZNSE MP5	1.5"	7.5"	.354"
BY314-8294MP5	996707, 10048294	MEN	ZNSE MP5	1.5"	9.0"	.354"
HW405-4913	114913	MEN	ZNSE MP5	2.0"	10.0"	.379"
HW405-5270	355270	MEN	ZNSE MP5	2.0"	5.0"	.378"
HW405-7143	527143, 467572, 60698LA, 291005-5, 308332, PLLM20025B	MEN	ZNSE MP5	2.0"	7.5"	.379"
MZ315-0160MP5	60770LA, 857048, Z50MB000160	PLX	ZNSE MP5	1.5"	5.0"	.236"
MZ315-0400MP5	106106, PLLPZ0132B, 60905LA, Z50MB000400, 62670ULA	PLX	ZNSE MP5	1.5"	5.0"	.300"
CN307-8085MP5	61001LA, 794914, 908085,	PLX	ZNSE MP5	1.5"	5.0"WD	.280"
MB312-018MP5	383862	PLX	ZNSE MP5	1.5"	7.5"	.300"
CN307-9484MP5	PLLPZ0052B	PLX	ZNSE MP5	1.5"	7.5"WD	.315"
MB312-505MP5	61003LA, 922203, W505	PLX	ZNSE MP5	2.0"	5.0"	.310"
AM313-0307NMP5	81140307, 61019LA, 753010	PLX	ZNSE MP5	2.0"	5.0"	.380"
CN307-0211MP5	540211, 61019LA, 922377	PLX	ZNSE MP5	2.0"	5.0"WD	.380"
MB312-510MP5	61004LA, 635061, W510,	PLX	ZNSE MP5	2.0"	7.5"	.310"
CN307-2376MP5	329011, 922376, 61515ULA,	PLX	ZNSE MP5	2.0"	7.5"	.380"
MZ315-0520AMP5	392125, 61405LA, Z50ZZ00520A, PLLPZ0135B, 81140186 61405ULA	PLX	ZNSE MP5	2.0"	7.5"	.380"

Centricut is not affiliated with the named manufacturers. Reference to machines, parts, descriptions, and model numbers are for convenience in verifying compatibility only. All parts are made by or for Centricut and are not made by the referenced manufacturers (unless expressly indicated). Centricut is a registered trademark of Hypertherm, Inc. All other trademarks are the properties of their respective owners.

Centricut part number	Reference number	Type	Material	Diameter	Focal length	Edge thickness
CO ₂ lenses (continued)						
AM313-0306MP5	65024LA, 81140306, 106106, M16-15-1C-P5.0, 6936448	PLX MTD	ZNSE MP5	1.5"	5.0"	.300"
AM313-1216MP5	106106, M20-15-1C-P5.0, 6071896	PLX MTD	ZNSE MP5	1.5"	5.0"	.300"
AM313-9830MP5	71369830, 106106, 65101LA, 106106/M16-15-1C-P5.0-A2-NI-1A	PLX MTD	ZNSE MP5	1.5"	5.0"	.300"
AM313-0400MP5	65025LA, 383862/M16-15-1C-P7.5-A2-NI-1A, 81140400, 383862	PLX MTD	ZNSE MP5	1.5"	7.5"	.300"
AM313-1215MP5	M21-15-1C-P7.5, 383862, 6071853	PLX MTD	ZNSE MP5	1.5"	7.5"	.300"
AM313-9831MP5	65102LA, 71369831, 383862	PLX MTD	ZNSE MP5	1.5"	7.5"	.300"
AM313-0307MP5	81140307, M16-20-1C-P5.0, 753010, 65035LA, 753010M16-20-1C-P5.0	PLX MTD	ZNSE MP5	2.0"	5.0"	.380"
AM313-0186MP5	392125, 65038LA, M16-20-1C-P7.5, 81140186, 6816292	PLX MTD	ZNSE MP5	2.0"	7.5"	.380"

Accessories

Centricut part number	Reference number	Description	Pkg qty
TR300-6452		Lens cleaning Tiffen paper (50 pcs)	1
TR300-1115		Lens cleaning pre-cut cotton (100 pcs)	1
TR300-1010		Dropper, lens cleaning fluid	1
TR300-1112		Optical cleaning fluid	1
TR300-0699	70675699 REVA	Lens cleaning swabs (25 pcs)	1
TR300-7991	27991	Polyester wipes 4" x 4" (100 pcs)	1
TR301-0282		Injector	1
TR300-LSA		Lens stress analyzer	1
TR300-255		Magnifying loop	1
TR300-271		Base, mirror maintenance	1
TR300-7388	787388	Mirror polish .1UM 250ML	1
MZ335-115	AL1115/M	MZ-Wire, Indium .8 mm x 125 mm 1.5" Lens	1
MZ335-120	AL1120/M	MZ-Wire, Indium .8 mm x 160 mm 2.0" Lens	1

Centricut is not affiliated with the named manufacturers. Reference to machines, parts, descriptions, and model numbers are for convenience in verifying compatibility only. All parts are made by or for Centricut and are not made by the referenced manufacturers (unless expressly indicated). Centricut is a registered trademark of Hypertherm, Inc. All other trademarks are the properties of their respective owners.

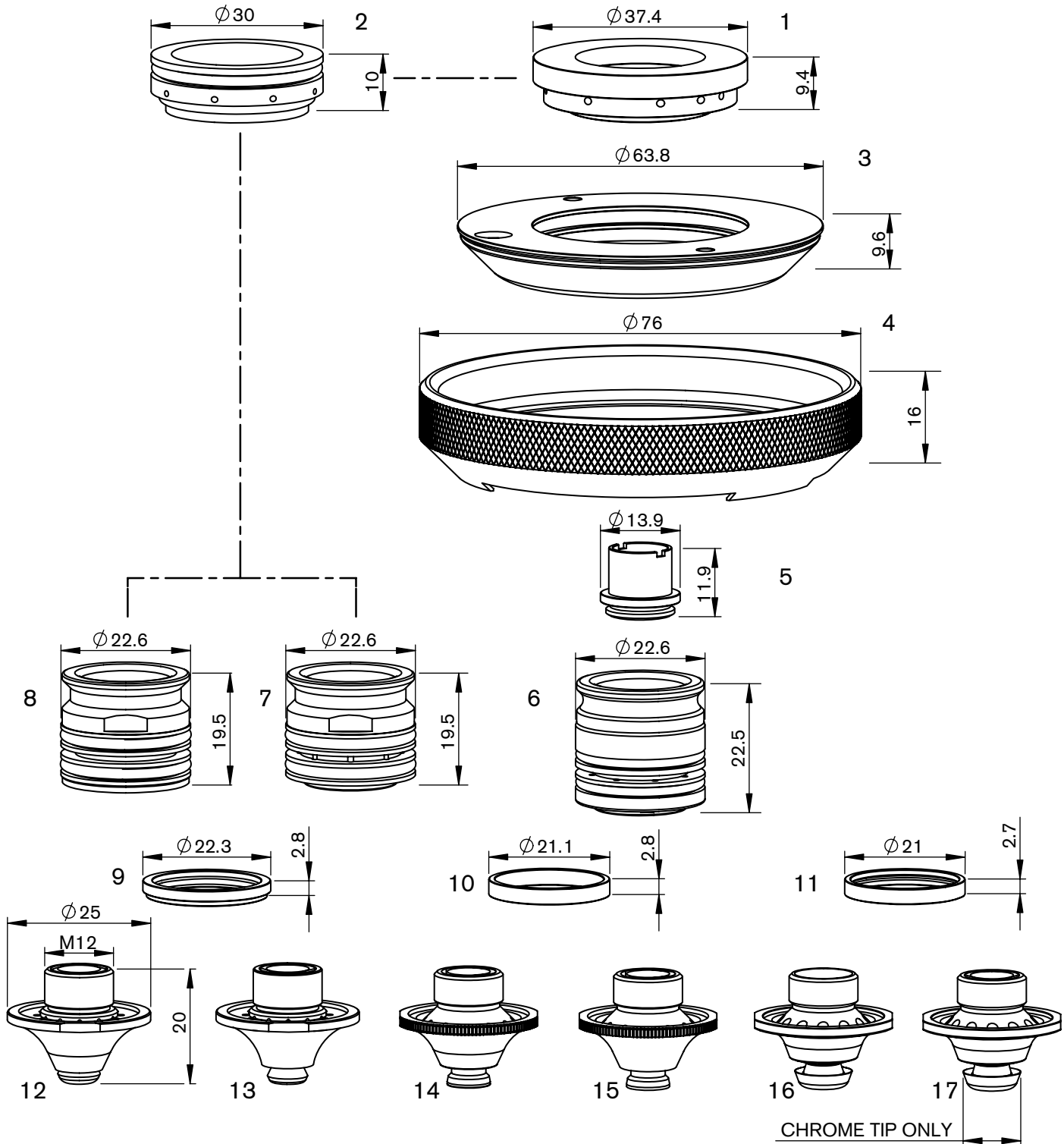
Consumables

	Centricut part number	Esse A part number	Reference number	Description	Pkg qty
1	AM367-2349	AL372	7973497, 71712349	AM-Holder, PTFE**	1
2	AM367-2026	AL340	71502026	AM-Holder, PTFE**	1
3	AM367-2342	AL456XH	71712342	AM-Cover kit	1
4	AM367-2341	AL455XH	71712341	AM-Nut kit	1

Centricut is not affiliated with the named manufacturers. Reference to machines, parts, descriptions, and model numbers are for convenience in verifying compatibility only. All parts are made by or for Centricut and are not made by the referenced manufacturers (unless expressly indicated). Centricut is a registered trademark of Hypertherm, Inc. All other trademarks are the properties of their respective owners.

Consumables

	Centricut part number	Esse A part number	Reference number	Description	Pkg qty
5	AM367-6438	AL392	71716438, 71798350	AM-Inner for adapter	1
6	AM367-0360	AL360	71712350, 7973459	AM-Nozzle adapter w/holes	1
	AM367-0364	AL360/AM	71712350, 7973459	AM-Nozzle adapter w/holes and inner	1
	AM367-0397 (not shown)	AL397		AM-O-ring kit for adapter (AM367-0360/0364)	1
7	AM367-2036	AL248	71502036	AM-Nozzle adapter w/8 holes	1
8	AM367-3036	AL348	71502036	AM-Nozzle adapter w/12 holes	1
9	AM367-0853	AL233		AM-O-ring, PTFE*	1
10	AM367-5853	AL234	71515853	AM-Ring, PTFE*	1
11	AM367-2340	AL361	71712340	AM-Ring w/groove, PTFE*	1
12	AM386-2025CP	L1155X	71502039, 71461026	AM-Nozzle double WACS w/holes, 2.5 mm CP	1
	AM386-2041CP	L1159X	71502040	AM-Nozzle double WACS w/holes, 4.0 mm CP	1
13	AM367-1014CP	L1041X	71461026	AM-Nozzle double WACS w/holes, 1.4 mm CP	1
	AM367-1017CP	L1043X	71461026	AM-Nozzle double WACS w/holes, 1.7 mm CP	1
	AM367-1020CP	L1044X	71461026	AM-Nozzle double WACS w/holes, 2.0 mm CP	1
	AM367-2039	L1045X	71502039, 71515850	AM-Nozzle double WACS w/holes, 2.5 mm CP	1
	AM367-2039-T NEW	L1045X/T		AM-Nozzle double WACS w/holes, 2.5 mm CP (with o-ring)	1
	AM367-2040	L1049X	71502040	AM-Nozzle double WACS w/holes, 4.0 mm CP	1
14	AM367-2336	L1568X		AM-Nozzle WACS, S1.2 mm CP	1
15	AM367-1352CP	L1352X	1576260	AM-Nozzle double WACS, D1.4 mm CP	1
	AM367-1160CP	L1352X/TG		AM-Nozzle double WACS w/Collar, D1.4 mm CP	1
	AM367-1353CP NEW	L1353X		AM-Nozzle double WACS, D1.7 mm CP	1
	AM367-1162CP	L1353X/TG		AM-Nozzle double WACS w/Collar, D1.7 mm CP	1
	AM367-1354CP	L1354X		AM-Nozzle double WACS, D2.0 mm CP	1
	AM367-1164CP	L1354X/TG		AM-Nozzle double WACS w/Collar, D2.0 mm CP	1
	AM367-1355CP	L1355X	71502039, 1576400A, 71461026, 1576400D	AM-Nozzle double WACS, D2.5 mm CP	1
	AM367-1156CP	L1355X/TG	71712335	AM-Nozzle double WACS w/Collar, D2.5 mm CP	1
	AM367-1166CP NEW	L1356X		AM-Nozzle double WACS, D3.0 mm CP	1
	AM367-1167CP NEW	L1356X/TG		AM-Nozzle double WACS w/Collar, D3.0 mm CP	1
	AM367-1168CP NEW	L1357X		AM-Nozzle double WACS, D3.5 mm CP	1
	AM367-1169CP NEW	L1357X/TG		AM-Nozzle double WACS w/Collar, D3.5 mm CP	1
	AM367-1158CP NEW	L1359X	71712336, 71461158, 1576402D	AM-Nozzle double WACS, D4.0 mm CP	1
	AM367-1157CP	L1359X/TG		AM-Nozzle double WACS w/Collar, D4.0 mm CP	1
AM367-1159CP NEW	L1360X		AM-Nozzle double WACS, D5.0 mm CP	1	
AM367-1165CP	L1360X/TG		AM-Nozzle double WACS w/Collar, D5.0 mm CP	1	
16	AM367-0019	L1653XH		AM-Nozzle fiber WACS, S0.8 mm Fe HCP	1
	AM367-0019C	L1653XH/TG		AM-Nozzle w/collar fiber WACS, S0.8 mm Fe HCP	1
	AM367-0030	L1654XH	71570030	AM-Nozzle fiber WACS, S1.0 mm Fe HCP	1
	AM367-0030C	L1654XH/TG	71570030	AM-Nozzle w/collar fiber WACS, S1.0 mm Fe HCP	1
	AM367-0023	L1655XH	71570023	AM-Nozzle fiber WACS, S1.2 mm Fe HCP	1
	AM367-0023C	L1655XH/TG	71570023	AM-Nozzle w/collar fiber WACS, S1.2 mm Fe HCP	1
	AM367-0024	L1656XH		AM-Nozzle fiber WACS, S1.4 mm Fe HCP	1
	AM367-0024C	L1656XH/TG		AM-Nozzle w/collar fiber WACS, S1.4 mm Fe HCP	1
	AM367-0027	L1657XH		AM-Nozzle fiber WACS, S1.7 mm Fe HCP	1
	AM367-0027C NEW	L1657XH/TG		AM-Nozzle w/collar fiber WACS, S1.7 mm Fe HCP	1
17	AM367-0026	L1658XH		AM-Nozzle fiber WACS, S2.0 mm Fe HCP	1
	AM367-0026C	L1658XH/TG		AM-Nozzle w/collar fiber WACS, S2.0 mm Fe HCP	1
	AM367-1900CP	L1900XH	71568227	AM-Nozzle double fiber, D1.2 mm Fe HCP	1
	AM367-1900CP-C NEW	L1900XH/TG		AM-Nozzle double fiber w/collar, D1.2 mm Fe HCP	1
	AM367-1901CP	L1901XH		AM-Nozzle double fiber, D1.5 mm Fe HCP	1
	AM367-1901CP-C NEW	L1901XH/TG		AM-Nozzle double fiber w/collar, D1.5 mm Fe HCP	1

* PolyTetraFluoroEthylene is a fluorocarbon-based polymer and is commonly abbreviated PTFE. The Teflon® brand of PTFE is manufactured only by DuPont and is not sold by Hypertherm. Hypertherm purchases other brands of PTFE from various high quality manufacturers.

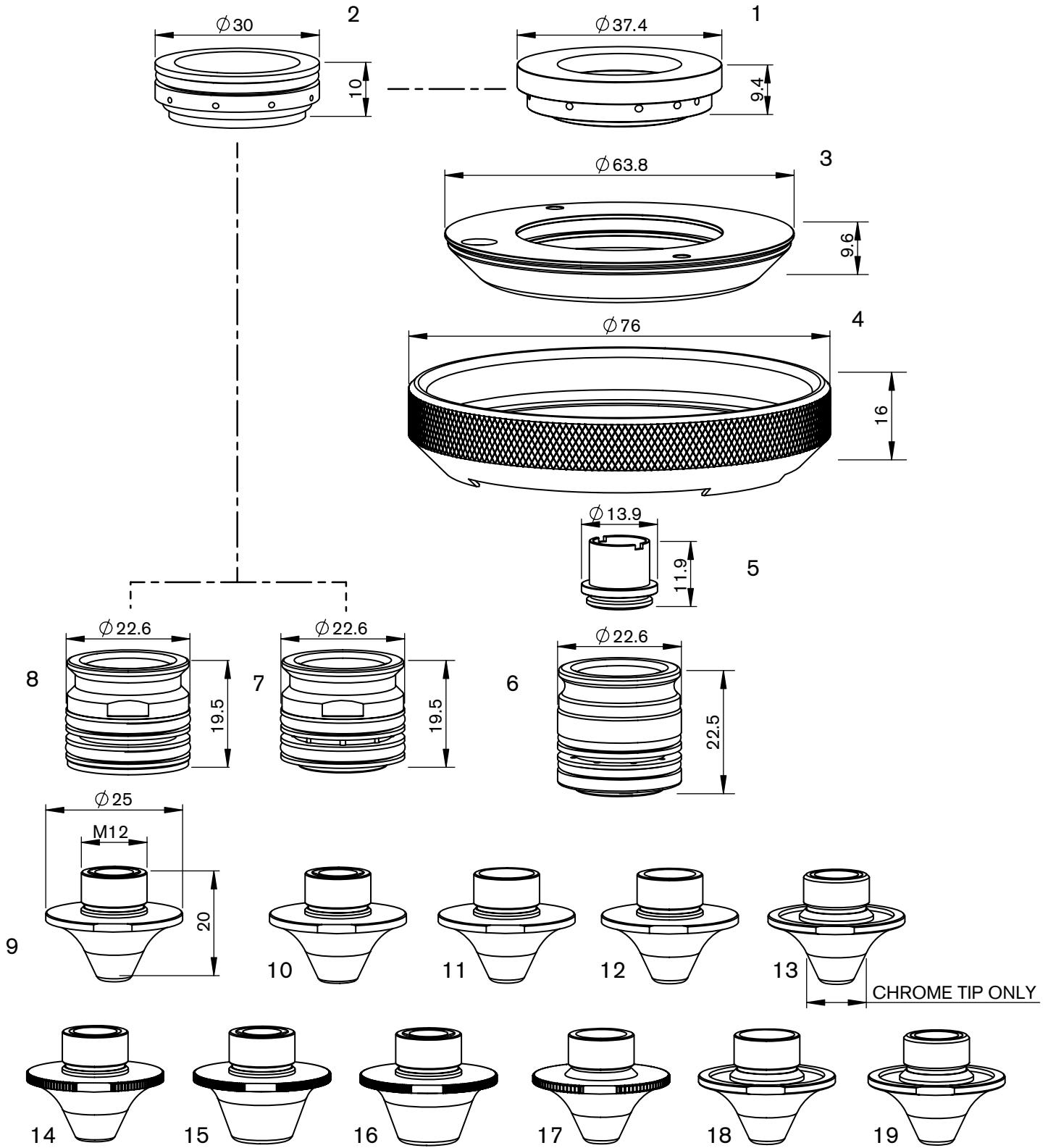

Centricut is not affiliated with the named manufacturers. Reference to machines, parts, descriptions, and model numbers are for convenience in verifying compatibility only. All parts are made by or for Centricut and are not made by the referenced manufacturers (unless expressly indicated). Centricut is a registered trademark of Hypertherm, Inc. All other trademarks are the properties of their respective owners.

Consumables

	Centricut part number	Esse A part number	Reference number	Description	Pkg qty
1	AM367-2349	AL372	7973497, 71712349	AM-Holder, PTFE**	1
2	AM367-2026	AL340	71502026	AM-Holder, PTFE**	1
3	AM367-2342	AL456XH	71712342	AM-Cover kit	1
4	AM367-2341	AL455XH	71712341	AM-Nut kit	1
5	AM367-6438	AL392	71716438, 71798350	AM-Inner for adapter	1
6	AM367-0360	AL360	71712350, 7973459	AM-Nozzle adapter w/holes	1
	AM367-0364	AL360/AM	71712350 and 7973459	AM-Nozzle adapter w/holes and inner	1
	AM367-0397 (not shown)	AL397		AM-O-ring kit for adapter (AM367-0360/0364)	1
7	AM367-2036	AL248	71502036	AM-Nozzle adapter w/8 holes	1
8	AM367-3036	AL348	71502036	AM-Nozzle adapter w/12 holes	1
9	AM367-8550X NEW	L301401X		AM-Nozzle double eco cut, D1.4 mm CP (10 pk)*	10
	AM367-6789X NEW	L301403X	71516789, 71501059	AM-Nozzle double eco cut, D2.5 mm CP (10 pk)*	10
	AM367-6795X NEW	L301404X		AM-Nozzle double eco cut, D3.0 mm CP (10 pk)*	10
	AM367-6790X NEW	L301405X	71516790	AM-Nozzle double eco cut, D4.0 mm CP (10 pk)*	10
10	AM367-6791CP	L1406X	71501093	AM-Nozzle double, D4.0 mm AL CP	1
11	AM367-1407CPX	L301407X	71502037, 71566686	AM-Nozzle eco cut, S1.2 mm CP (10 pk)*	10
12	AM367-1410CPX NEW	L301410X		AM-Nozzle eco cut, S1.4 mm CP (10 pk)*	10
	AM367-1411CPX NEW	L301411X	71501056, 71712720	AM-Nozzle eco cut, S1.5 mm CP (10 pk)*	10
	AM367-1412CPX NEW	L301412X	71501057, 71555124	AM-Nozzle eco cut, S2.0 mm CP (10 pk)*	10
	AM367-1413CPX NEW	L301413X	71516788, 71501058	AM-Nozzle eco cut, S3.0 mm CP (10 pk)*	10
13	AM367-1161CP	L1644XH		AM-Nozzle double, D1.5 mm CP	1
	AM367-1163CP	L1645XH	71570022	AM-Nozzle double, D2.0 mm CP	1
14	AM367-1727CP	L1415XH		AM-Nozzle double clean cut, D2.5 mm HCP	1
	AM367-1728	L1416XH	71341728, 71555121	AM-Nozzle double clean cut, D4.0 mm HCP	1
15	AM367-1717CP	L1417XH		AM-Nozzle double clean cut, D5.0 mm HCP	1
	AM367-1718CP	L1418XH		AM-Nozzle double clean cut, D6.0 mm HCP	1
	AM367-1729CP	L1419XH	71341729, 71712721	AM-Nozzle double clean cut, D7.0 mm HCP	1
	AM367-1092CP	L1425X	71501092	AM-Nozzle double clean cut, D7.0 mm AL CP	1
16	AM367-1770CP	L1420X	71712692	AM-Nozzle double silky cut, D7.0 mm CP	1
17	AM367-1421CP	L1421XH		AM-Nozzle clean cut, S1.5 mm HCP	1
	AM367-1422CP	L1422XH	71502043	AM-Nozzle clean cut, S2.0 mm HCP	1
	AM367-1423CP	L1423XH	71502044	AM-Nozzle clean cut, S3.0 mm HCP	1
	AM367-1424CP	L1424XH		AM-Nozzle clean cut, S2.5 mm HCP	1
18	AM367-1561	L1561X	71570021, S1.0FE	AM-Nozzle, S1.0 mm Fe CP	1
	AM367-1562	L1562X	71570020, S1.2FE	AM-Nozzle FE, S1.2 mm Fe CP	1
	AM367-1563	L1563X	S1.4FE	AM-Nozzle, S1.4 mm Fe CP	1
19	AM367-0020	L1645X	71570022	AM-Nozzle double, D2.0 mm Fe CP	1
	AM367-0025	L1646X		AM-Nozzle double, D2.5 mm Fe CP	1
	AM367-0040	L1649X		AM-Nozzle double, D4.0 mm Fe CP	1

* Centricut parts available in single packs. To order single packs, remove the 'X' at the end of the part number (e.g. AM123-4567X would be AM123-4567).

For Esse A parts available in single packs. To order single packs, remove the '30' after the L in the part number (e.g. L301401X would be L401X).

** PolyTetraFluoroEthylene is a fluorocarbon-based polymer and is commonly abbreviated PTFE. The Teflon® brand of PTFE is manufactured only by DuPont and is not sold by Hypertherm. Hypertherm purchases other brands of PTFE from various high quality manufacturers.

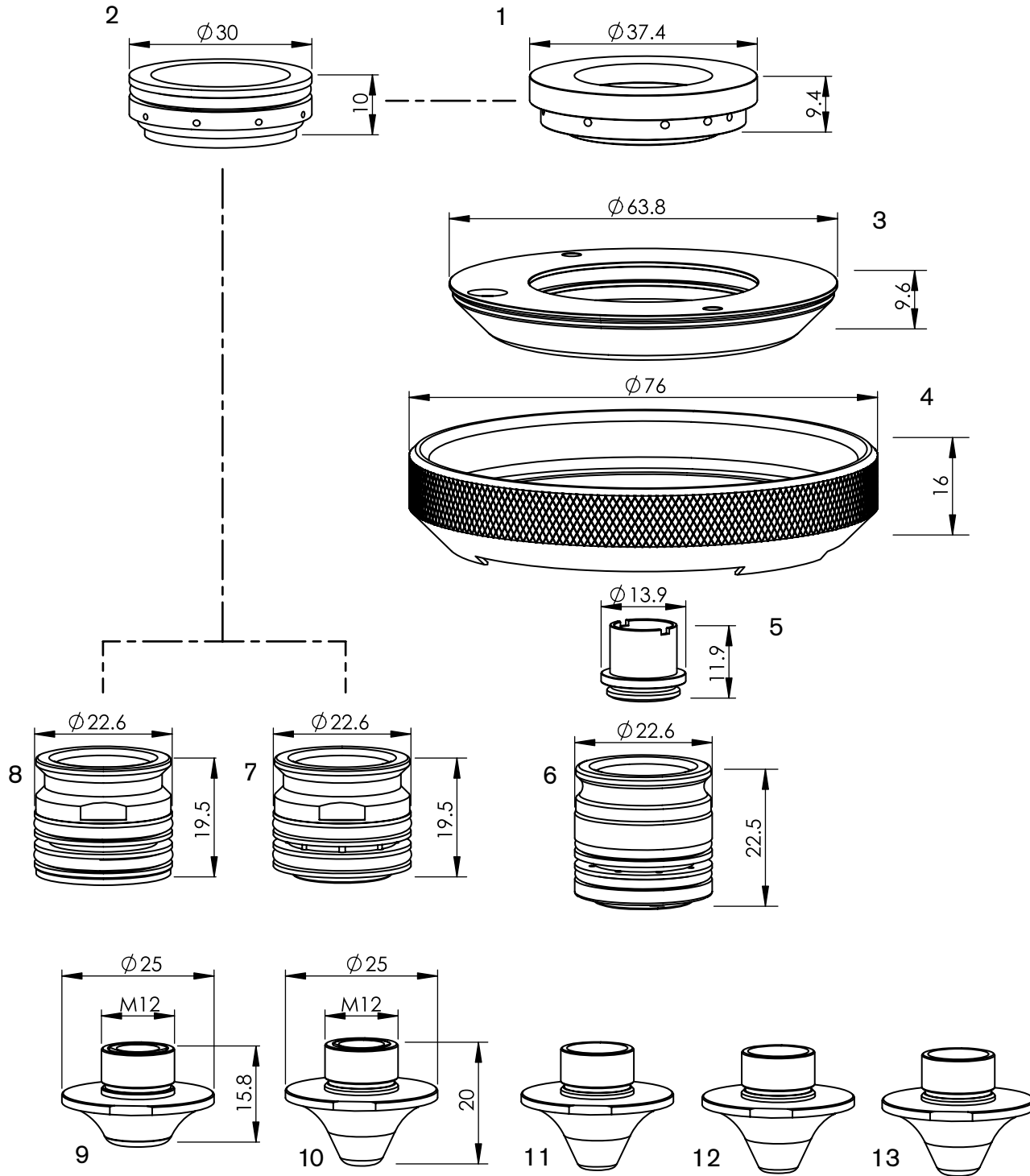
Consumables

	Centricut part number	Esse A part number	Reference number	Description	Pkg qty
1	AM367-2349	AL372	7973497, 71712349	AM-Holder, PTFE**	1
2	AM367-2026	AL340	71502026	AM-Holder, PTFE**	1
3	AM367-2342	AL456XH	71712342	AM-Cover kit	1
4	AM367-2341	AL455XH	71712341	AM-Nut kit	1
5	AM367-6438	AL392	71716438, 71798350	AM-Inner for adapter	1

Centricut is not affiliated with the named manufacturers. Reference to machines, parts, descriptions, and model numbers are for convenience in verifying compatibility only. All parts are made by or for Centricut and are not made by the referenced manufacturers (unless expressly indicated). Centricut is a registered trademark of Hypertherm, Inc. All other trademarks are the properties of their respective owners.

Consumables

	Centricut part number	Esse A part number	Reference number	Description	Pkg qty
6	AM367-0360	AL360	71712350, 7973459	AM-Nozzle adapter w/holes	1
	AM367-0364	AL360/AM	71712350, 7973459	AM-Nozzle adapter w/holes and inner	1
	AM367-0397 (not shown)	AL397		AM-O-ring kit for adapter (AM367-0360/0364)	1
7	AM367-2036	AL248	71502036	AM-Nozzle adapter w/8 holes	1
8	AM367-3036	AL348	71502036	AM-Nozzle adapter w/12 holes	1
9	AM343-2340CPS	L565X		AM-Nozzle double short, 4.0 mm CP	1
10	AM343-2361-1.2X NEW	L30585X	1572361	AM-Nozzle double, 1.2 mm CP (10 pk)*	10
	AM343-9813X NEW	L30586X	71369813, 71502038, 1576396C, 71341779, 71518550	AM-Nozzle double, 1.4 mm CP (10 pk)*	10
	AM343-2361-1.7X NEW	L30574X	1572361, 71518548, 1572380	AM-Nozzle double, 1.7 mm CP (10 pk)*	10
	AM343-2361-2.0X NEW	L30587X	1572361	AM-Nozzle double, 2.0 mm CP (10 pk)*	10
	AM343-2361-2.5X NEW	L30584X	71515394, 71516789, 1576398, 1576398B, 71501059	AM-Nozzle double, 2.5 mm CP (10 pk)*	10
	AM343-2361-3X NEW	L30588X	1572361, 71516788	AM-Nozzle double, 3.0 mm CP (10 pk)*	10
	AM343-9817X NEW	L30589X	71501060, 71515395, 71516790, 1576399B,	AM-Nozzle double, 4.0 mm CP (10 pk)*	10
	AM367-1037X NEW	L301037X		AM-Nozzle double, 4.0 mm /inner 2.0 mm CP (10 pk)*	10
	AM343-2350CPX NEW	L30583X	1572361	AM-Nozzle double, 5.0 mm CP (10 pk)*	10
	AM343-0569X NEW	L30569X		AM-Nozzle double, 6.0 mm CP (10 pk)*	10
11	AM367-1608HCP NEW		71341781, 71369822, 1572362, 71563584	AM-Nozzle, 0.8 mm Hard CP	1
	AM367-1610HCP NEW		1572367, 1572367A, 7156358	AM-Nozzle, 1.0 mm Hard CP	1
	AM367-1612HCP NEW		71369812, 71461028, 1576410C, 71341778	AM-Nozzle, 1.2 mm Hard CP	1
	AM343-9812CPX			AM-Nozzle, 1.2 mm CP (10 pk)	10
	AM367-1614HCP NEW		1572362	AM-Nozzle, 1.4 mm Hard CP	1
	AM367-1615HCP NEW		1572362, 1572368B	AM-Nozzle, 1.5 mm Hard CP	1
	AM367-1617HCP NEW		1572362	AM-Nozzle, 1.7 mm Hard CP	1
	AM367-1620HCP NEW		71515392, 71369815, 1576411B	AM-Nozzle, 2.0 mm Hard CP	1
	AM367-1625HCP NEW			AM-Nozzle, 2.5 mm Hard CP	1
	AM367-1630HCP NEW		71515393, 1576412B, 1576112	AM-Nozzle, 3.0 mm Hard CP	1
	AM367-1640HCP NEW		1572362	AM-Nozzle, 4.0 mm Hard CP	1
		L30590X NEW	71341781, 71369822, 1572362, 71563584	AM-Nozzle, 0.8 mm CP (10 pk)*	10
		L30591X NEW	1572367, 1572367A, 7156358	AM-Nozzle, 1.0 mm CP (10 pk)*	10
		L30592X NEW	71369812, 71461028, 1576410C, 71341778	AM-Nozzle, 1.2 mm CP (10 pk)*	10
		L30592X NEW		AM-Nozzle, 1.2 mm CP (10 pk)*	10
		L30593X NEW	1572362	AM-Nozzle, 1.4 mm CP (10 pk)*	10
		L30597X NEW	1572362, 1572368B	AM-Nozzle, 1.5 mm CP (10 pk)*	10
		L30575X NEW	1572362	AM-Nozzle, 1.7 mm CP (10 pk)*	10
		L30594X NEW	71515392, 71369815, 1576411B	AM-Nozzle, 2.0 mm CP (10 pk)*	10
		L30572X NEW		AM-Nozzle, 2.5 mm CP (10 pk)*	10
	L30595X NEW	71515393, 1576412B, 1576112	AM-Nozzle, 3.0 mm CP (10 pk)*	10	
	L30596X NEW	1572362	AM-Nozzle, 4.0 mm CP (10 pk)*	10	
12	AM343-0004CPX NEW	L301027X		AM-Nozzle straight taper, 0.8 mm CP (10 pk)*	10
	AM343-0005CPX NEW	L301028X		AM-Nozzle straight taper, 1.0 mm CP (10 pk)*	10
	AM343-0006CPX NEW	L301029X		AM-Nozzle straight taper, 1.2 mm CP (10 pk)*	10
	AM343-0007CPX NEW	L301030X		AM-Nozzle straight taper, 1.4 mm CP (10 pk)*	10
	AM343-0001CPX NEW	L30599X		AM-Nozzle straight taper, 1.5 mm CP (10 pk)*	10
	AM343-0002CPX NEW	L3030598X		AM-Nozzle straight taper, 2.0 mm CP (10 pk)*	10
	AM343-0009CPX NEW	L301033X		AM-Nozzle straight taper, 2.3 mm CP (10 pk)*	10
	AM343-0003CPX NEW	L30571X		AM-Nozzle straight taper, 3.0 mm CP (10 pk)*	10
	AM343-0003CP	L571X		AM-Nozzle straight taper, 3.0 mm CP	1
13	AM367-2037	L1026X	71502037	AM-Nozzle w/concave, 1.2 mm CP	1
	AM367-2038	L1031X	71502038	AM-Nozzle double w/concave, 1.4 mm CP	1

* Centricut parts available in single packs. To order single packs, remove the 'X' at the end of the part number (e.g. AM123-4567X would be AM123-4567).

For Esse A parts available in single packs. To order single packs, remove the '30' after the L in the part number (e.g. L301401X would be L401X).

** PolyTetraFluoroEthylene is a fluorocarbon-based polymer and is commonly abbreviated PTFE. The Teflon® brand of PTFE is manufactured only by DuPont and is not sold by Hypertherm. Hypertherm purchases other brands of PTFE from various high quality manufacturers.

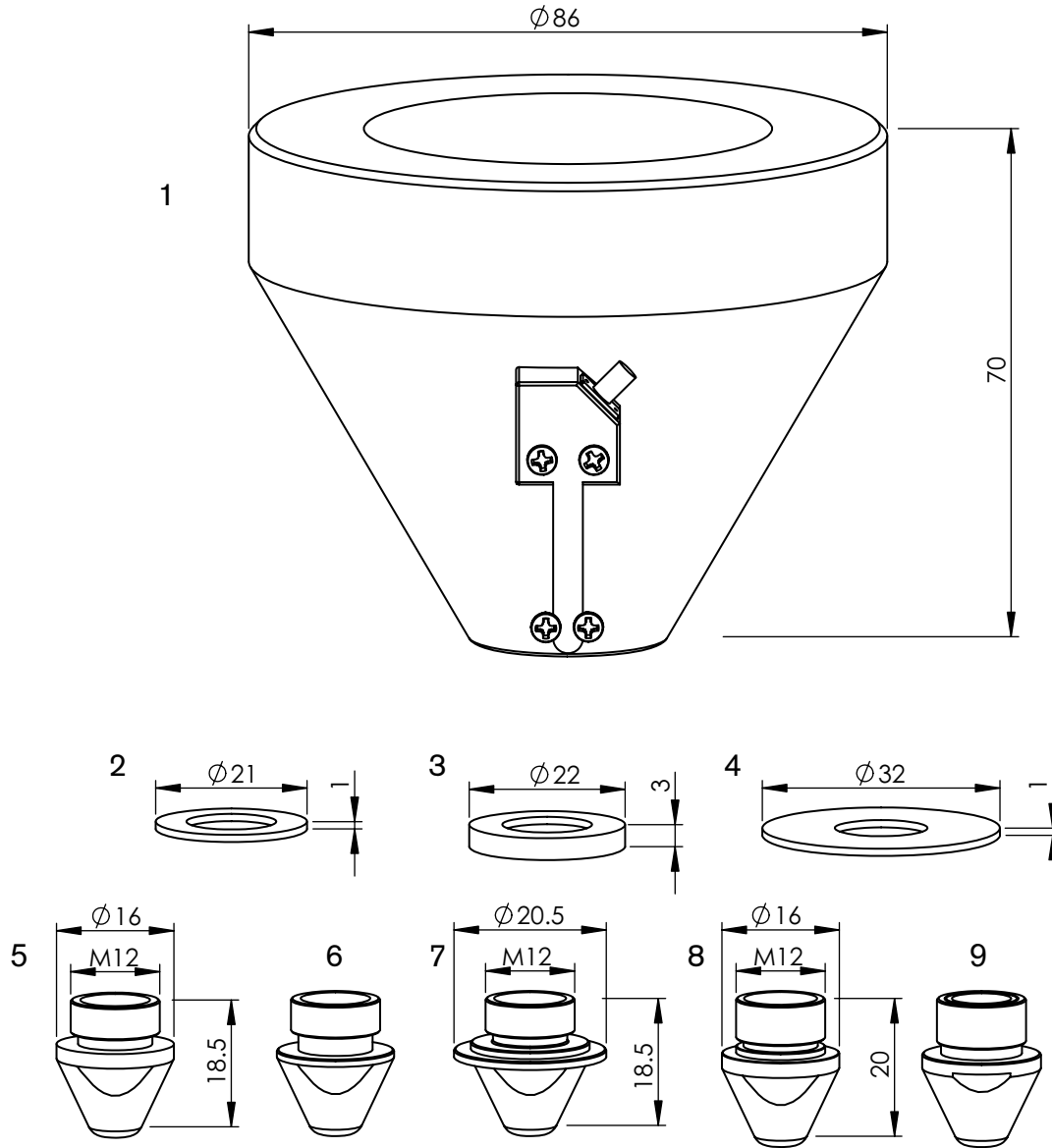

Consumables

	Centricut part number	Esse A part number	Reference number	Description	Pkg qty
1	AM343-1621		71360091	AM-Sensor cone, HS95	1
	AM343-0091 (not shown)		71341621	AM-Sensor cone, HS95 mini	1
2	AM325-325-1	AL1005	71341614	AM-Head protection disc, 21 mm plastic	1
	AM325-1614	AL122	71341614, 71369818	AM-Head protection disc, 21 mm Vespel	1
3	AM325-325-2	AL123	71341614	AM-Head protection disc, 22 mm ceramic	1
4	AM325-9819	AL42	71639819	AM-Head protection disc, 32 mm	1

Centricut is not affiliated with the named manufacturers. Reference to machines, parts, descriptions, and model numbers are for convenience in verifying compatibility only. All parts are made by or for Centricut and are not made by the referenced manufacturers (unless expressly indicated). Centricut is a registered trademark of Hypertherm, Inc. All other trademarks are the properties of their respective owners.

Consumables

	Centricut part number	Esse A part number	Reference number	Description	Pkg qty
5	AM325-545U-1.0	L134X	1664545U	AM-Nozzle, 1.0 mm CP	1
	AM325-0010CPX	L30134X	1664545U	AM-Nozzle, 1.0 mm CP (10 pk)	10
	AM325-545U-1.25	L135X	1664545U	AM-Nozzle, 1.25 mm CP	1
	AM325-0125CPX	L30135X	1664545U	AM-Nozzle, 1.25 mm CP (10 pk)	10
	AM325-545U-1.5	L86X	1664545U, 71341619, M90115	AM-Nozzle, 1.5 mm CP	1
	AM325-0015CPX	L3086X	1664545U	AM-Nozzle, 1.5 mm CP (10 pk)	10
	AM325-0175CPX	L30136X	1664545U	AM-Nozzle, 1.75 mm CP (10 pk)	10
	AM325-545U-2.0	L137X	1664545U, 71341610, M90114	AM-Nozzle, 2.0 mm CP	1
	AM325-0020CPX	L30137X	1664545U, 71341610	AM-Nozzle, 2.0 mm CP (10 pk)	10
	AM325-545U-2.5	L203X	1664545U	AM-Nozzle, 2.5 mm CP	1
	AM325-0025CPX	L30203X	1664545U	AM-Nozzle, 2.5 mm CP (10 pk)	10
	AM325-4544UX	L30138X	1664545U, 71360142	AM-Nozzle, 3.0 mm CP (10 pk)*	10
	AM325-0400CPX	L30339X		AM-Nozzle, 4.0 mm CP (10 pk)*	10
6	AM325-0002CPX	L30193X		AM-Nozzle, 1.25 mm CP (10 pk)	10
	AM325-0003CPX	L30194X		AM-Nozzle, 1.5 mm CP (10 pk)*	10
	AM325-0005CPX	L30196X		AM-Nozzle, 2.0 mm CP (10 pk)*	10
	AM325-0007CPX	L30198X		AM-Nozzle, 3.0 mm CP (10 pk)*	10
7	AM325-1500CP	L1067X		AM-Nozzle large flange, 1.5 mm CP	1
	AM325-2000CP	L1066X		AM-Nozzle large flange, 2.0 mm CP	1
	AM325-3000CP	L1068X		AM-Nozzle large flange, 3.0 mm CP	1
8	AM325-1770	L1285X	71341770, 1667110	AM-Nozzle, 2.0 mm CP	1
	AM325-1730	L1287X		AM-Nozzle, 3.0 mm CP	1
9	AM326-9864-1.0	L390X	1669864, 7134162	AM-Nozzle double, 1.0 mm CP	1
	AM326-9864-1.2	L392X	1669864, 7134162	AM-Nozzle double, 1.2 mm CP	1
	AM326-9864-1.4	L393X	1669864, 7134162	AM-Nozzle double, 1.4 mm CP	1
	AM326-9864-1.5	L391X	1669864, 7134162	AM-Nozzle double, 1.5 mm CP	1
	AM326-9864-2.0	L315X	1669864, 7134162	AM-Nozzle double, 2.0 mm CP	1
	AM326-9864-2.5	L316X	1669864, 7134162, 41341680, 71341772	AM-Nozzle double, 2.5 mm CP	1
	AM326-9864-3.0	L317X	1669864, 7134163	AM-Nozzle double, 3.0 mm CP	1
	AM326-9864-4.0	L318X	1669795, 71341681	AM-Nozzle double, 4.0 mm CP	1

* Centricut parts available in single packs. To order single packs, remove the 'X' at the end of the part number (e.g. AM123-4567X would be AM123-4567). For Esse A parts available in single packs. To order single packs, remove the '30' after the L in the part number (e.g. L301401X would be L401X).

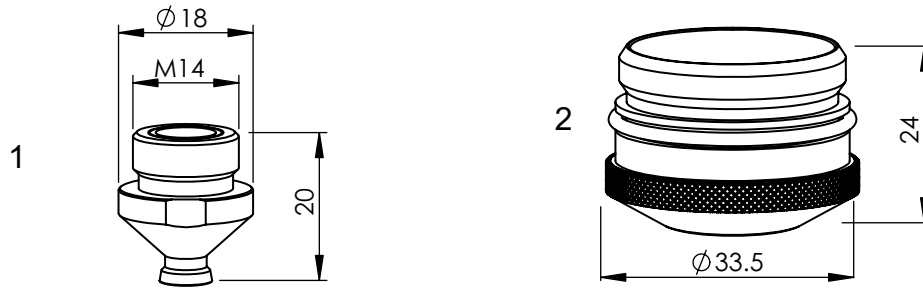

Consumables

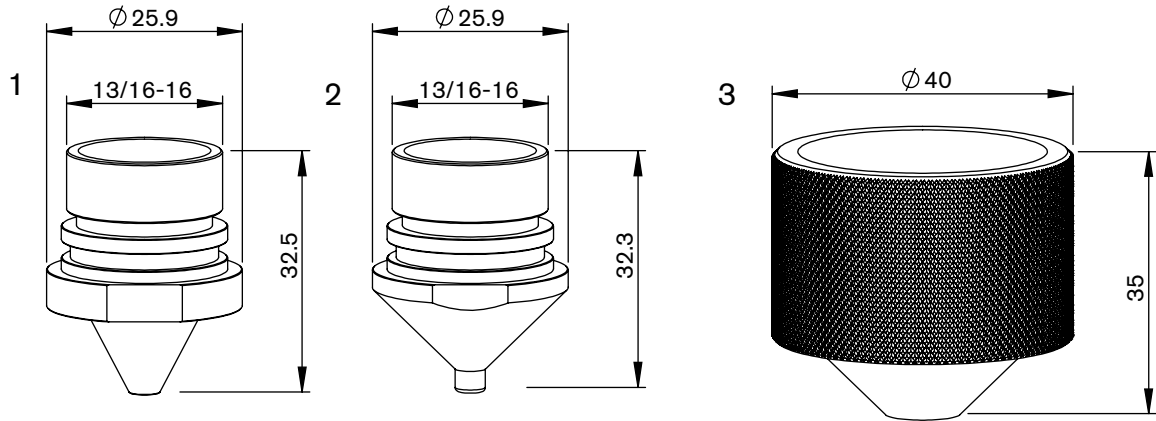
	Centricut part number	Esse A part number	Reference number	Description	Pkg qty
1	AM326-1218-2.5	L321X	6551218, 71341682, 71341680	AM-Nozzle double, 2.5 mm CP	1
	AM326-1218-3.0	L322X	6551218, 71341682	AM-Nozzle double, 3.0 mm CP	1
	AM326-1218-3.8	L323X	6551218, 71341682	AM-Nozzle double, 3.8 mm CP	1
	AM326-4140CP	L330X	6551218, 71341682	AM-Nozzle double, 4.0 mm CP	1
2	AM326-6452	AL115X	71366452, 71341684, 6551148A	AM-Nozzle outer, CP	1
	AM326-S-14 (not shown)	AL93	S-14	AM-O-ring for nozzle (10 pcs)	10
	AM326-6453 (not shown)	AL94	71366453	AM-O-ring for outer nozzle (10 pcs)	10

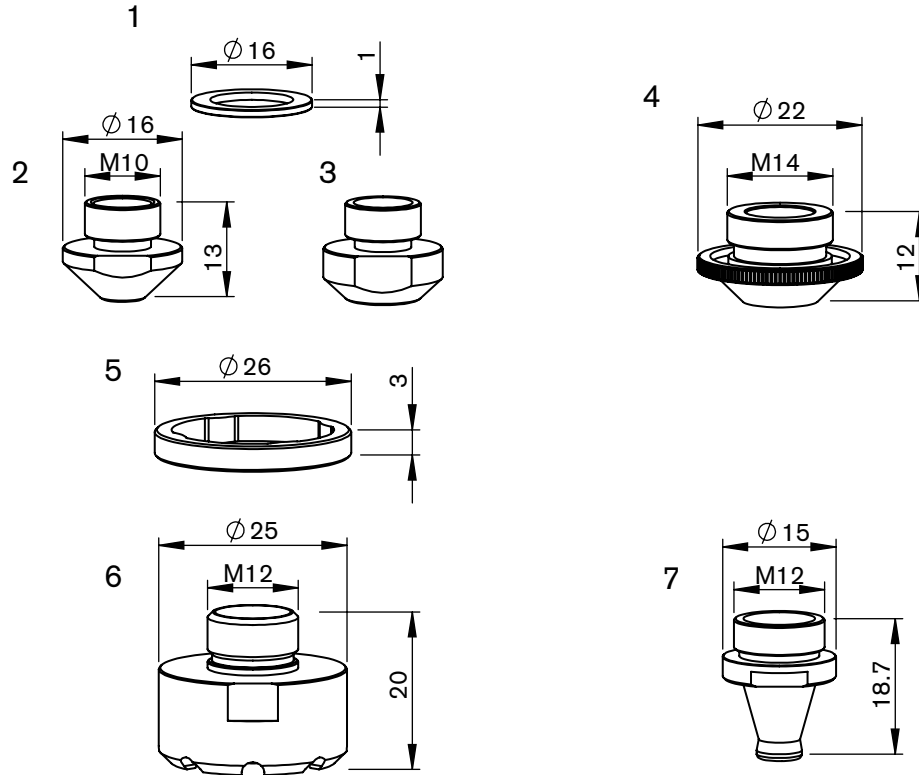

Consumables

	Centricut part number	Esse A part number	Reference number	Description	Pkg qty
1	AM324-6892-2.0	L39X	74712001, 6506892	AM-Nozzle, 2.0 mm CP	1
2	AM308-1902	L91X	71101902	AM-Nozzle, 1.5 mm CP	1
	AM308-1901-2.0	L29X	71101901, 845735	AM-Nozzle, 2.0 mm CP	1
3	AM308-1905	L30X	71101905, 841143B	AM-Nozzle outer, CP	1
	AM308-S-20 (not shown)	AL90	S-20	AM-O-ring kit (10 pk)	10
	AM308-AS-34 (not shown)	AL96	1AS-34	AM-O-ring for outer nozzle	1



Consumables

	Centricut part number	Esse A part number	Reference number	Description	Pkg qty
1	AM325-4006-R	AL107	62094006-ring	AM-Head protection disc, 16 mm	1
2	AM325-4006-1.5	L173X	62094006, 1507610	AM-Nozzle, 1.5 mm CP	1
	AM325-4015CPX	L30173X	62094006, 1507610	AM-Nozzle, 1.5 mm CP (10 pk)	10
	AM325-4006-2.0	L27X	62094006, 1507611	AM-Nozzle, 2.0 mm CP	1
	AM325-4020CPX	L3027X	62094006, 1507611	AM-Nozzle, 2.0 mm CP (10 pk)	10
	AM325-4025CPX	L30175X	62094006	AM-Nozzle, 2.5 mm CP (10 pk)*	10
	AM325-4030CPX	L3028X	62094008, 71102007	AM-Nozzle, 3.0 mm CP (10 pk)	10
3	AM325-4005-1.5	L752X	62094005, 71341515	AM-Nozzle, 1.5 mm CP	1
	AM325-4005-2.0	L754X	62094005, 71102006	AM-Nozzle, 2.0 mm CP	1
	AM325-1520CPX	L30754X	62094005, 71102006	AM-Nozzle, 2.0 mm CP (10 pk)	10
	AM325-1530CP	L756X	62094005, 71341515-3.0	AM-Nozzle, 3.0 mm CP	1
4	AM308-8815CP	L95X		AM-Nozzle, 1.5 mm CP	1
	AM308-8820CP	L38X	74718816, 8249301	AM-Nozzle, 2.0 mm CP	1
5	AM367-3028	AL403		AM-Collar, PTFE**	1
6	AM367-1333	L1333		AM-Nozzle, 2.0 mm	1
	AM369-0002	L927X		AM-Nozzle HP-X, 1.0 mm CP	1
7	AM369-0005	L930X		AM-Nozzle HP-X, 2.0 mm CP	1
	AM369-0007	L932X	71362733	AM-Nozzle HP-X, 3.0 mm CP	1

* Centricut parts available in single packs. To order single packs, remove the 'X' at the end of the part number (e.g. AM123-4567X would be AM123-4567).

For Esse A parts available in single packs. To order single packs, remove the '30' after the L in the part number (e.g. L301401X would be L401X).

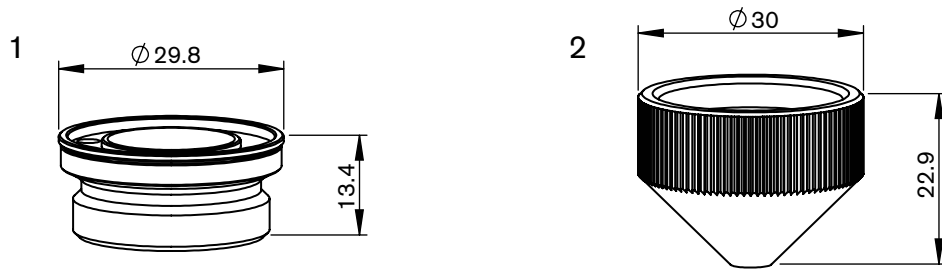
** PolyTetraFluoroEthylene is a fluorocarbon-based polymer and is commonly abbreviated PTFE. The Teflon® brand of PTFE is manufactured only by DuPont and is not sold by Hypertherm. Hypertherm purchases other brands of PTFE from various high quality manufacturers.



Consumables

	Centricut part number	Esse A part number	Reference number	Description	Pkg qty
1	MB334-0001	AL267	P0594-860-00001, PHX-INS	MB-Nozzle holder	1
2	MB316-269S	AL238	71800027, BQ933D221H04, P0593-860-00001	MB-Shield cap, short	1
	MB316-269SCP	AL238X		MB-Shield cap, short CP	1

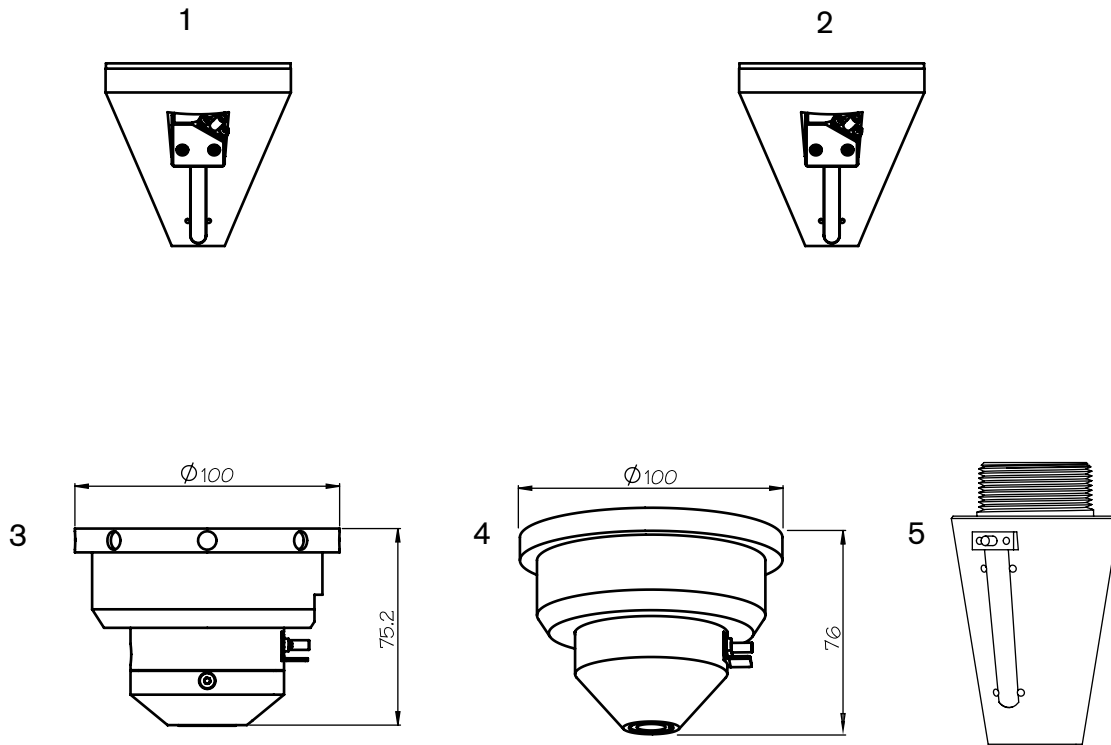

Consumables

	Centricut part number	Esse A part number	Reference number	Description	Pkg qty
New Sensor Cones					
1	AM343-0091		71360091	AM-Sensor cone, HS95 mini	1
2	AM343-1621		71341621	AM-Sensor cone, HS95	1
3	AM343-9107		71399107, 71341622	AM-Sensor cone, ECO	1
4	AM343-1690		71341690	AM-Sensor cone, HS98	1
5	AM343-L3015C		71374509	AM-Sensor cone, LC3015	1
	AM999-DUSTCAP NEW (not shown)			AM-Dust cap, HPX	1
	AM343-4233B NEW (not shown)		71564233	AM-Sensor cone, HPL Black	
	AM343-4233G NEW (not shown)		71564233	AM-Sensor cone, HPL Gold	

*Repair is available in N. America for many sensor cones

Centricut is not affiliated with the named manufacturers. Reference to machines, parts, descriptions, and model numbers are for convenience in verifying compatibility only. All parts are made by or for Centricut and are not made by the referenced manufacturers (unless expressly indicated). Centricut is a registered trademark of Hypertherm, Inc. All other trademarks are the properties of their respective owners.

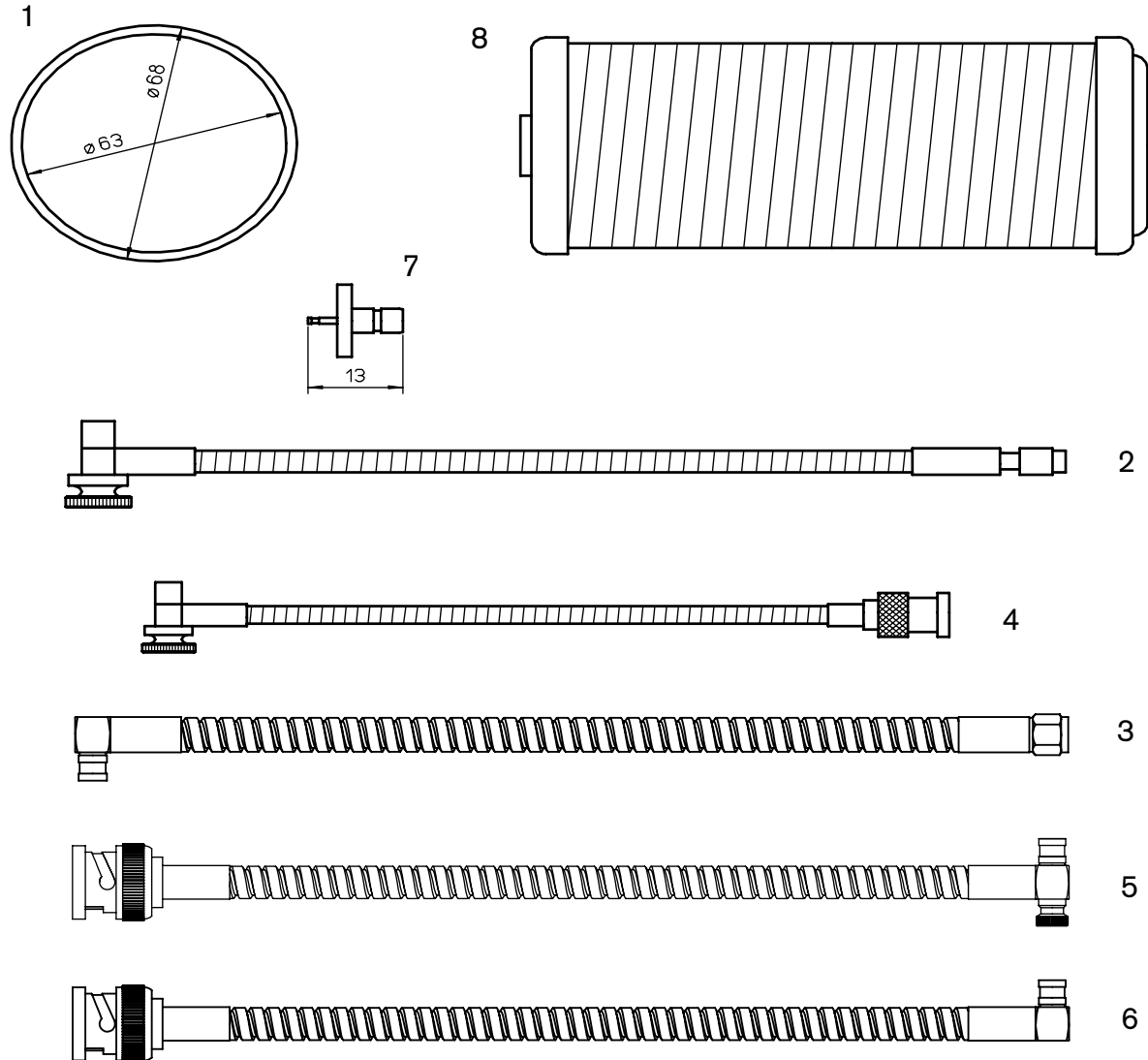
Consumables

	Centricut part number	Esse A part number	Reference number	Description	Pkg qty
1	AM313-0004	AL56		AM-Gasket, sensor head, PTFE*	1
2	AM313-1901	AL200	71341901,71341630	AM-Sensor cable, 305 mm (12")	1
3	AM313-1901A		71398293, 71341901	AM-Sensor cable HS-5, 305 mm (12") premium, armored	1
4	AM308-8965	AL260	71516520, 71341901	AM-Sensor cable, 305 mm (12")	1
5	AM308-8965A		71516520, 71341901	AM-Sensor cable, 305 mm (12") premium, armored	1
6	AM313-9851A		71369851	AM-Sensor cable, 230 mm (8") premium	1
7	AM308-0001	AL263		AM-Sensor cable connector	1
8	AM313-2023		71232023, 712-32-023, Z50PMB00090	AM-Vacuum pump filter	1
	AM313-1526 (not shown)			AM-Sensor cable ZS6, 530 mm	1
	AM313-8292 (not shown)		71398292	AM-Sensor cable dual shield, 7 meters	1

*PolyTetraFluoroEthylene is a fluorocarbon-based polymer and is commonly abbreviated PTFE. The Teflon® brand of PTFE is manufactured only by DuPont and is not sold by Hypertherm. Hypertherm purchases other brands of PTFE from various high quality manufacturers.

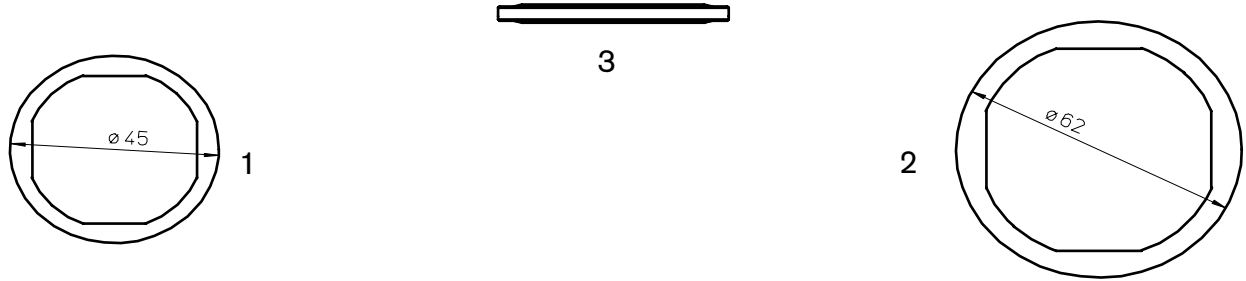

Consumables

	Centricut part number	Esse A part number	Reference number	Description	Pkg qty
Centricut lens housings and assemblies					
1	AM313-0005	AL52	71360261, 74721907	AM-Gasket, 1.5" lens housing, PTFE*	1
2	AM313-9513	AL149	71361393	AM-Gasket 2.0" lens housing, PTFE*	1
3	AM313-1071	AL249	71501071	AM-Gasket	1

*PolyTetraFluoroEthylene is a fluorocarbon-based polymer and is commonly abbreviated PTFE. The Teflon® brand of PTFE is manufactured only by DuPont and is not sold by Hypertherm. Hypertherm purchases other brands of PTFE from various high quality manufacturers.

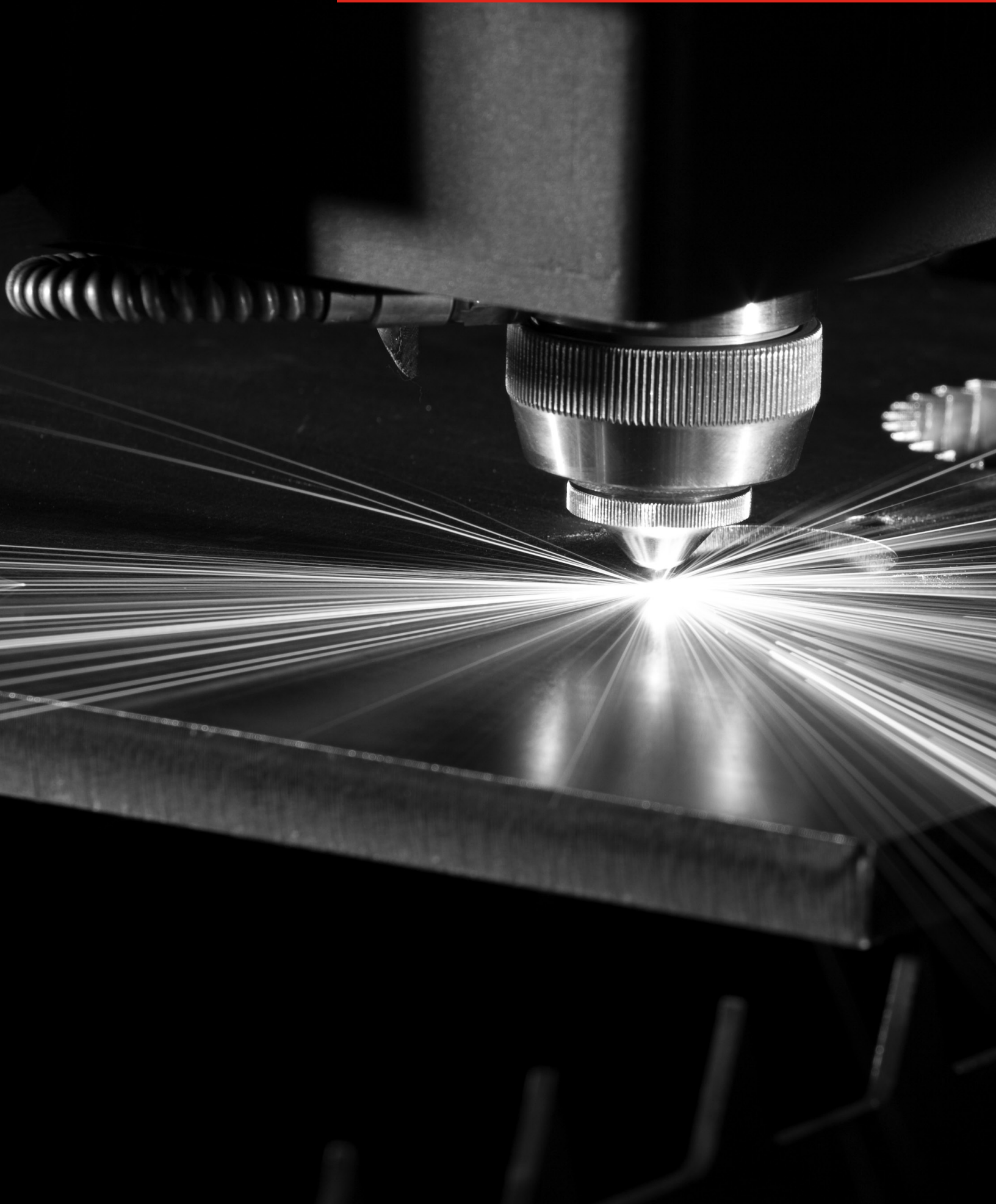

Sensor cones



Centricut sensor cones provide substantial cost savings without sacrificing performance or quality

- Available for Amada, Mazak, Mitsubishi and Precitec
- Delivers the same OEM performance at a lower cost
- Unmatched performance and reliability
- Engineered and manufactured to Hypertherm's precise quality standards
- Backed by our one-year warranty and 100% satisfaction guarantee

Centricut part number	OEM	Reference number	Description
AM343-0091	Amada	71360091	AM-Sensor cone, HS95 mini
AM343-1621*	Amada	71341621	AM-Sensor cone, HS95
AM343-9107	Amada	ECO cone	AM-Sensor cone, ECO
AM343-1690	Amada	71341690	AM-Sensor cone, HS98
AM343-L3015C	Amada	71374509	PT-Sensor cone, LC3015
AM343-4233B*	Amada	71564233	AM-Sensor cone, HPL Black
AM343-4233G*	Amada	71564233	AM-Sensor cone, HPL Gold
PT347-3323	Mazak	HNP	PT-Sensor cone, HNP
MZ335-HNPS*	Mazak	HNPS	MZ-Sensor cone, HNP short version
PT347-0007	Mazak	56743300500	PT-Sensor cone, HNZ (Mazak)
PT347-0011*	Mitsubishi	P0354-110-00002	PT-Sensor cone, HNZ (Mitsubishi)
MB334-W429A	Mitsubishi	P0461-270-00001	MB-Sensor cone, W429A
PT347-0238*	Precitec	BQ930D238G01	PT-Sensor cone, HNZ SMA
PT347-8001	Precitec	P0361-203-00001	PT-Sensor cone, 2.5Z/J
PT347-0522*	Precitec	P0599-520-00002	PT-Sensor cone, LRC
PT347-1145	Precitec	P0380-140-0002, P0380-130-00001, 281145	PT-Sensor cone, DZ

*Sensor cone repair service is available for most sensor cones in North America and select international regions. For more information contact Ctlaser@Hypertherm.com.

Centricut is not affiliated with the named manufacturers. Reference to machines, parts, descriptions, and model numbers are for convenience in verifying compatibility only. All parts are made by or for Centricut and are not made by the referenced manufacturers (unless expressly indicated). Centricut is a registered trademark of Hypertherm, Inc. All other trademarks are the properties of their respective owners.

Armored sensor cables

Centricut armored sensor cables outlast standard OEM cables

- Available for all major brands
- Robust design with extreme temperature rating (900–1200°)
- Longer life reduces downtime and production loss
- Spatter resistant stainless steel armoring
- Reinforced collars and high-quality connector

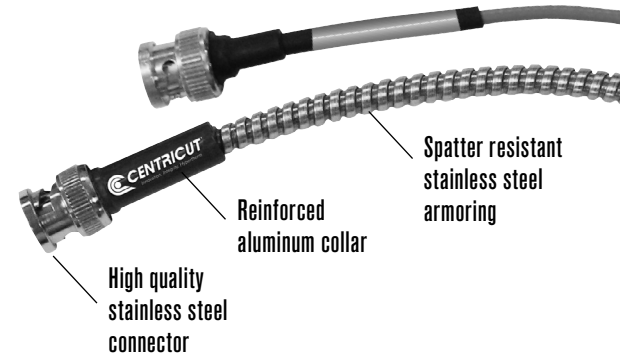

Armored sensor cables

Centricut part number	OEM	Reference number	Description
AM308-8965	Amada	71398965	AM-Sensor cable, 305 mm (12")
AM308-8965A	Amada	71398965	AM-Sensor cable, 305 mm (12") armored
AM313-1901	Amada	71341630	AM-Sensor cable HS-5, 305 mm (12")
AM313-1901A	Amada	71341630	AM-Sensor cable HS-5, 305 mm (12") armored
AM313-8292	Amada	71398292	AM-Sensor cable dual shield, 7 m (275.6")
AM313-9851A	Amada	71369851	AM-Sensor cable, 203 mm (8") armored
CN306-0654A	Cincinnati	909654, 922686	CN-Sensor cable, 114 mm (4.5") armored
CN306-0951A	Cincinnati	842951	CN-Sensor cable, 140 mm (5.5") armored
CN306-2951	Cincinnati	842951, PLTTW0015	CN-Sensor cable, 140 mm (5.5")
CN306-9654	Cincinnati	909654, 922686, PLTTW0002	CN-Sensor cable, 114 mm (4.5")
MZ335-0111A	Mazak	4674330111	MZ-Sensor cable, 280 mm (11") armored
MZ335-0181A	Mazak	46743300181	MZ-Sensor cable, 317.5 mm (12.5") armored
MZ335-1330A	Mazak	46683301330	MZ-Sensor cable, 305 mm (12") armored
MZ335-1980A	Mazak	46683301980	MZ-Sensor cable, 280 mm (11") armored
MZ335-5320	Mazak	6143355320	MZ-Sensor cable, 61.5 mm (2.4") armored
MZ335-630A	Mazak	00BSBA630MNC	MZ-Sensor cable, 630 mm (25") armored
MZ335-8290	Mazak	46143308290	MZ-Sensor cable, 75 mm (3")
NT426-1682	NTC	4R029911-001, J482D	NT-Sensor cable, 216 mm (8.5")
NT426-4991	NTC	3-0104991	NT-Sensor cable 0-0BNC/MCX, 482 mm (19")
NT426-7492	NTC	3-0117492	NT-Sensor cable 90BNC/90BNC, 482 mm (19")
NT426-8677	NTC	4R028677-001	NT-Sensor cable, 508 mm (20") armored
PR361-3150	Prima	820.63.150	PR-Sensor cable, 150 mm (5.9")
PR361-3151	Prima	820.63.150	PR-Sensor cable, 150 mm (6") high profile
PR361-3160	Prima	555.63.150	PR-Sensor cable, 210 mm (8 17/64")
PT347-0101A	Precitec	P0360-100-00500	PT-Sensor cable, 500 mm (20") armored
PT347-0181	Precitec	46743300181	PT-Sensor cable, 305 mm (12") armored
PT347-0250	Precitec	342475	PT-Sensor cable, 250 mm (9.8") armored
PT347-0300A	Precitec	P0492-014-00300	PT-Sensor cable KE, 300 mm (11.8") armored
PT347-0450	Precitec	P0497-002-00450	PT-Sensor cable, 450 mm (17.7")
PT347-KS13	Precitec/ Gunkyo	00BMTKA-A-HS500mm	PT-Sensor cable, 390 mm (15.5") armored
PT347-1250	Precitec	D5001-040-00250	PT-Sensor cable, 250 mm (9.8") armored
TR301-0930	Trumpf	280930	TR-Sensor cable, 152 mm (6") armored
TR301-7833	Trumpf	227833	TR-Sensor cable, 432 mm (17")
TR301-9983	Trumpf	359983, 342474	TR-Sensor cable, 190 mm (7.5") armored

Centricut is not affiliated with the named manufacturers. Reference to machines, parts, descriptions, and model numbers are for convenience in verifying compatibility only. All parts are made by or for Centricut and are not made by the referenced manufacturers (unless expressly indicated). Centricut is a registered trademark of Hypertherm, Inc. All other trademarks are the properties of their respective owners.

Lens cleaning tips



Centricut supplies suitable for all OEM CO₂ and fiber laser lenses

- Lens maintenance base is designed to secure a wide range of optics sizes for the cleaning process
- Centricut optical cleaning fluid is a safe, economical alternative to traditional high-purity and reagent-grade solvents
- Cleaning materials suited for all lens cleaning needs; lens paper, polyester swabs and polyester wipes

Lens paper

Recommended for the routine maintenance cleaning of flat lenses.

Polyester swabs

Recommended for cleaning curved lenses and where a more aggressive cleaning is required (interchangeable with polyester wipes).

Polyester wipes

Recommended for cleaning CO₂ and fiber lenses and windows (interchangeable with polyester swabs and lens paper).

Product description	Part number	Quantity per order
Optical cleaning fluid (3 oz.)	TR300-1112	1
Lens cleaning swab	TR300-0699	25
Lens cleaning paper, Tiffen	TR300-6452	50
Polyester wipes 4" x 4"	TR300-7991	100
Base, lens maintenance	TR300-271	1

Lens paper

Recommended for the routine maintenance cleaning of flat lenses.

You will need:

- Lens maintenance base (lens holder)
- Optical cleaning fluid
- Air bulb
- Lint-free lens paper
- Latex or rubber gloves

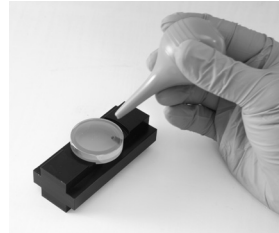

To get started

Using rubber gloves, place the lens in the lens holder and remove all loose contaminants with an air bulb. When contaminants are no longer visible, begin the cleaning process.

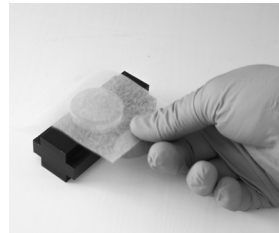

Step 1

Place lens paper over the optic, covering it completely.



Step 2

Apply a couple drops of lens cleaning fluid to the lens paper (far side of the lens).

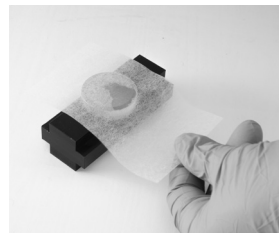

Step 3

Slowly pull the lens paper across the lens so the cleaning fluid comes in contact with the entire lens surface. Finish pulling the paper across so all of the fluid has dried from the lens.

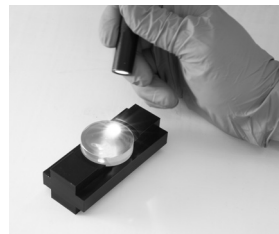

Step 4

Inspect the surface of the lens for dust and cleaning residue using a flashlight. Examine the lens from different angles. Repeat the process on the other side of the lens.

Final step:

Place the cleaned lens in the machine quickly to avoid contamination from airborne particles. If spots, pits, or scratches are still noticeable, the lens may need to be replaced.

Centricut is not affiliated with the named manufacturers. Reference to machines, parts, descriptions, and model numbers are for convenience in verifying compatibility only. All parts are made by or for Centricut and are not made by the referenced manufacturers (unless expressly indicated). Centricut is a registered trademark of Hypertherm, Inc. All other trademarks are the properties of their respective owners.

Polyester swabs

Recommended for cleaning curved lenses and where more aggressive cleaning is required. Interchangeable with polyester wipes.

You will need:

- Lens maintenance base (lens holder)
- Optical cleaning fluid
- Air bulb
- Polyester swabs
- Latex or rubber gloves

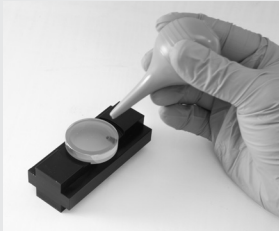

To get started

Using rubber gloves, place the lens in the lens holder and remove all loose contaminants with an air bulb. When contaminants are no longer visible, begin the cleaning process.

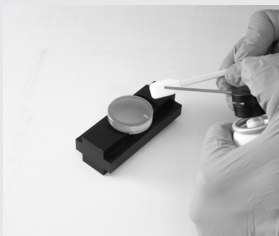

Step 1

Place a few drops of the optical cleaning fluid onto the swab.

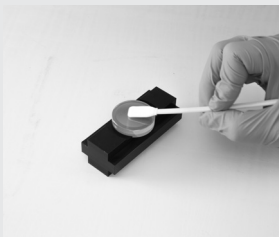

Step 2

Move the larger dirt particles and then finer contaminants to the edge of the lens using the swab. Do not rest the swab on the lens or on the work table. Do not reuse swabs.

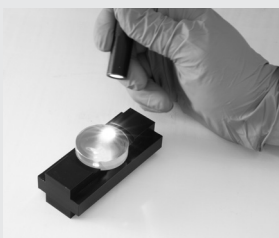

Step 3

Inspect the surface of the lens for dust and cleaning residue using a flashlight. Examine the lens from different angles. Repeat the process on the other side of the lens.

Final step:

Place the cleaned lens in the machine quickly to avoid contamination from airborne particles. If spots, pits, or scratches are still noticeable, the lens may need to be replaced.

Polyester wipes

Recommended for cleaning CO₂ and fiber lenses and windows. Interchangeable with polyester swabs and lens paper.

You will need:

- Lens maintenance base (lens holder)
- Optical cleaning fluid
- Air bulb
- Polyester wipes
- Latex or rubber gloves

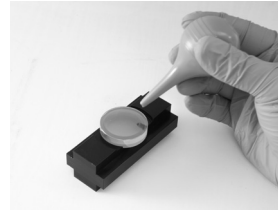

To get started

Using rubber gloves, place the lens in the lens holder and remove all loose contaminants with an air bulb. When contaminants are no longer visible, begin the cleaning process.

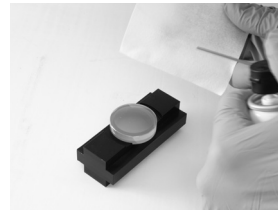

Step 1

Place a few drops of the optical cleaning fluid onto the polyester wipe.



Step 2

Place the wipe with the wet side down on the lens and slide it across the lens, applying light pressure to the top of the wipe. Avoid contamination to the wipe and do not reuse wipes.

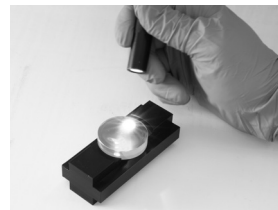

Step 3

Inspect the surface of the lens for dust and cleaning residue using a flashlight. Examine the lens from different angles. Repeat the process on the other side of the lens.

Final step:

Place the cleaned lens in the machine quickly to avoid contamination from airborne particles. If spots, pits, or scratches are still noticeable, the lens may need to be replaced.

Steps to help optimize cut quality.

Striation marks, angularity and dross tell the story.

Optimizing CO₂ and fiber lasers to achieve maximum cut quality is a very important step in the overall cutting process. The critical points that produce good cuts are the width of the kerf (the material that is lost during the cut), oxidation and roughness of the cut surface, the geometry of the cut parts and the allowable tolerances. Some factors to be considered are the cut speed or 'feed rate', beam focus, gas pressure, standoff and nozzle size/type.

Factory cut chart settings

The following samples show 12 mm, 6 mm and 3.2 mm (1/2", 1/4" and 10 ga.) mild steel, cut with O₂ on a 2 kW fiber laser with one variable changed to show how cut quality is affected. The adjustments will be similar for all CO₂ and fiber laser, cutting mild steel with O₂.

Is the kerf too narrow?

When the kerf is too narrow the cut will have a very smooth edge on the top, a lack of oxidation on the bottom and/or heavy dross.

Probable causes:

- Focus is too low
- Feed rate is too fast
- Gas pressure is too low
- Nozzle size is too small
- Standoff is too low

Follow these steps to optimize cut quality:

1. Use the closest known settings for the material being cut.
2. Use a test part that has both interior and exterior features.
3. Verify that the lens and/or window is clean and in good condition.
4. Verify that the nozzle is centered properly and is in good condition.
5. Adjust the focus up and down until the cut quality starts to get bad and then set to the middle of that range.
6. Adjust the gas pressure up and down until the cut starts to get bad and then set to the middle of that range.
7. Adjust the feed rate up by 5% increments. When the cut starts to get bad, set the feed rate 10% slower.

Strike a balance between heat levels and gas flow

Cutting mild steel with a laser is a balance of how much material is heated by the laser beam and how much assist gas flows through the cut.

- Heating up too small of an area, or not having enough assist gas flow through the cut will result with the kerf (width of the cut) being too narrow.
- Heating up too large of an area or having too much assist gas flow through the cut will result in the kerf being too wide.

Is the kerf too wide?

When the kerf is too wide the cut will have a rougher edge, more self burning in the corners of the part, more angularity on the cut edge and occasionally, dross.

Probable causes:

- Focus is too high
- Feed rate is too slow
- Gas pressure is too high
- Nozzle size is too big
- Standoff is too high
- Incorrect nozzle type

3.2 mm (10 ga.) mild steel cut resulting in too narrow kerf

Factory cut chart settings



Focus is too low

The kerf is too narrow and doesn't allow enough O₂ into the cut to remove all the molten material.

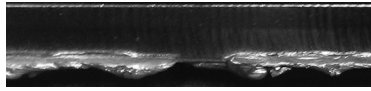

Feed rate is too fast

The cut striations are trailing the direction of cutting and there is not enough time to remove all the molten material.

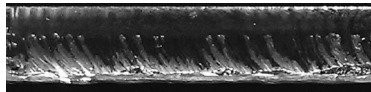

Gas pressure is too low

There is not enough O₂ to remove all the molten material.

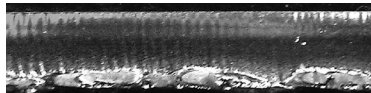

Stand off is too low

The focus spot is in the wrong location, causing the rough edge.

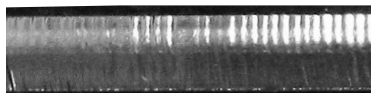

3.2 mm (10 ga.) mild steel cut resulting in too wide kerf

Factory cut chart settings

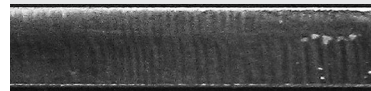

Focus is too high

The laser is melting more material than can be removed from the cut.

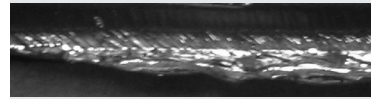

Feed rate is too slow

The cut surface is too rough and productivity is decreased.

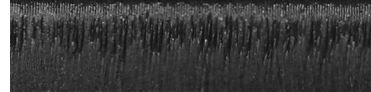

Gas pressure is too high

Too much O₂ results in overheating of the cut and causes intermittent gouges.

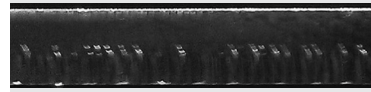

Stand off is too high

The laser is melting more material than can be removed from the cut.

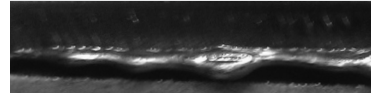

Nozzle size is too big

Too much O₂ results in overheating of the cut and causes intermittent gouges.



Cut direction

Cut direction

*Above samples have been cut with O₂ on 2 kW fiber laser. Results will be similar for CO₂ laser cutting mild steel with O₂.

Centricut is not affiliated with the named manufacturers. Reference to machines, parts, descriptions, and model numbers are for convenience in verifying compatibility only. All parts are made by or for Centricut and are not made by the referenced manufacturers (unless expressly indicated). Centricut is a registered trademark of Hypertherm, Inc. All other trademarks are the properties of their respective owners.

**6 mm (1/4") mild steel cut
resulting in too narrow kerf**

Factory cut chart settings

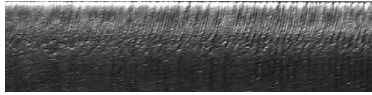

Focus is too low

The kerf is too narrow and doesn't allow enough O₂ into the cut to remove all the molten material.

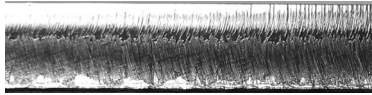

Feed rate is too fast

The cut striations are trailing the direction of cutting and there is not enough time to remove all the molten material.

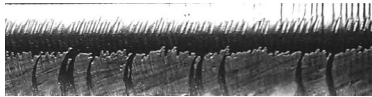

Gas pressure is too low

There is not enough O₂ to remove all the molten material.

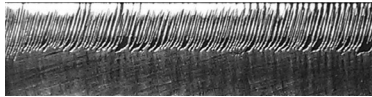

Stand off is too low

The focus spot is in the wrong location, causing the rough edge.

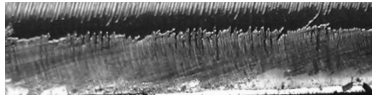

Nozzle size is too small

There is not enough O₂ to cut uniformly

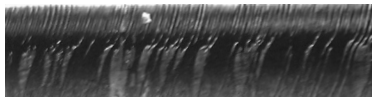

**6 mm (1/4") mild steel cut
resulting in too wide kerf**

Factory cut chart settings

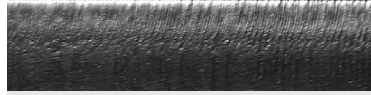

Focus is too high

The wider focus spot is letting too much O₂ into the cut and burning the material.

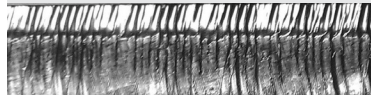

Feed rate is too slow

The cut surface is too rough and productivity is decreased.

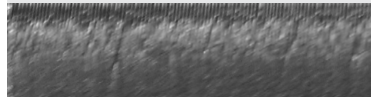

Gas pressure is too high

Too much O₂ is entering the cut, causing a rougher edge and inconsistent cutting.



Stand off is too high

Too much O₂ is entering the cut, causing a rougher edge and inconsistent cutting.

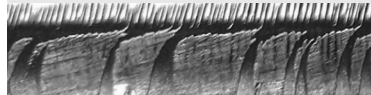

Nozzle size is too big

Too much O₂ results in overheating of the cut and causes intermittent gouges.



Nozzle type is incorrect

The shape of the gas flow is incorrect, causing a rougher edge.

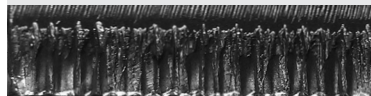

Cut direction

Cut direction

*Above samples have been cut with O₂ on 2 kW fiber laser. Results will be similar for CO₂ laser cutting mild steel with O₂.

Centricut is not affiliated with the named manufacturers. Reference to machines, parts, descriptions, and model numbers are for convenience in verifying compatibility only. All parts are made by or for Centricut and are not made by the referenced manufacturers (unless expressly indicated). Centricut is a registered trademark of Hypertherm, Inc. All other trademarks are the properties of their respective owners.

12 mm (1/2") mild steel cut resulting in too narrow kerf

Factory cut chart settings

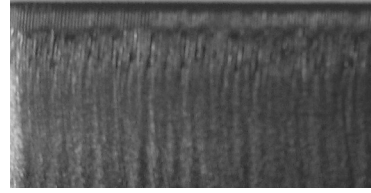
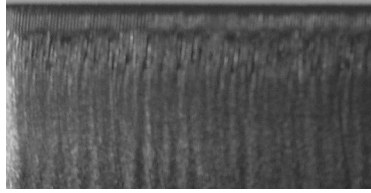

Factory cut chart settings

Focus is too low

The kerf is too narrow and doesn't allow enough O₂ into the cut to remove all the molten material.

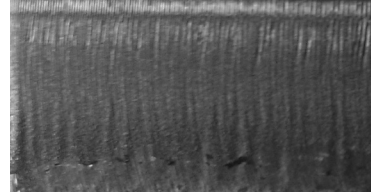
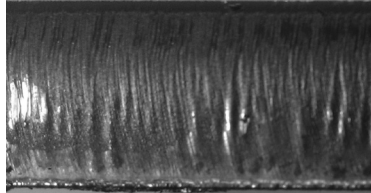

Stand off is too low

The kerf is too narrow to allow enough O₂ into the cut. The oxidation is not covering the entire surface and cutting will be inconsistent.

Feed rate is too fast

The machine is moving too fast to allow enough O₂ into the cut for consistent cutting.

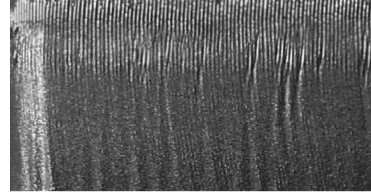
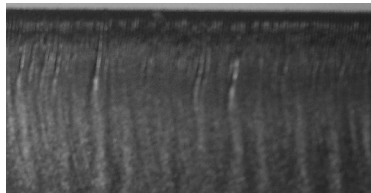

Nozzle size is too small

There is not enough O₂ to cut uniformly

Gas pressure is too low

The pressure is too low to allow enough O₂ into the cut. The oxidation is not covering the entire surface and cutting will be inconsistent.

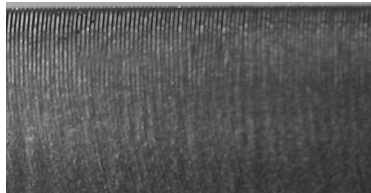

Cut direction

Cut direction

*Above samples have been cut with O₂ on 2 kW fiber laser. Results will be similar for CO₂ laser cutting mild steel with O₂.

Centricut is not affiliated with the named manufacturers. Reference to machines, parts, descriptions, and model numbers are for convenience in verifying compatibility only. All parts are made by or for Centricut and are not made by the referenced manufacturers (unless expressly indicated). Centricut is a registered trademark of Hypertherm, Inc. All other trademarks are the properties of their respective owners.

12 mm (1/2") mild steel cut resulting in too wide kerf

Factory cut chart settings

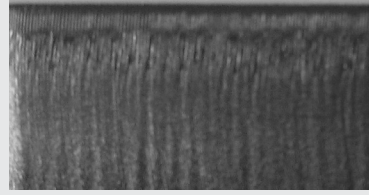
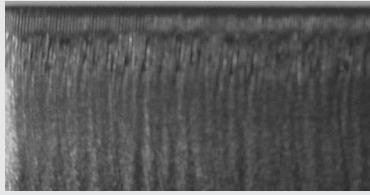

Factory cut chart settings

Focus is too high

Too much O₂ is entering the cut causing intermittent over burning.

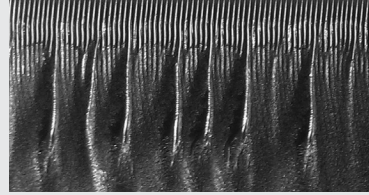
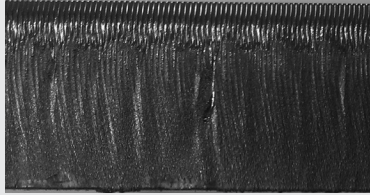

Stand off is too high

Too much O₂ is entering the cut resulting in intermittent over burning.

Feed rate is too slow

The machine is moving too slow resulting in the over burning of the bottom half of the cut. The slower feed rate also reduces productivity.

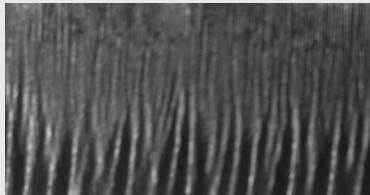

Incorrect nozzle type

The gas flow shape is not correct resulting in inconsistent cutting.

Gas pressure is too high

Too much O₂ is entering the cut resulting in intermittent over burning.

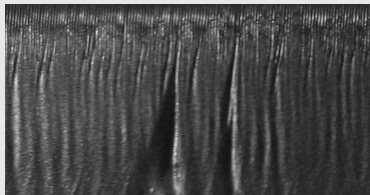

*Above samples have been cut with O₂ on 2 kW fiber laser. Results will be similar for CO₂ laser cutting mild steel with O₂.

Centricut is not affiliated with the named manufacturers. Reference to machines, parts, descriptions, and model numbers are for convenience in verifying compatibility only. All parts are made by or for Centricut and are not made by the referenced manufacturers (unless expressly indicated). Centricut is a registered trademark of Hypertherm, Inc. All other trademarks are the properties of their respective owners.

Technical support and customer service

Our technical service team can answer questions about any laser cutting system. Whether it's a question about a part, a system or for guidance on how to optimize laser cutting performance, our experts can help.

- OEM trained technicians with over 40 years experience
- Free application support for all laser OEMs
- We stand behind our products with industry-leading technical expertise



Contact a laser expert at ctlaser@hypertherm.com

HELPING YOU SHAPE THE WORLD.



PLASMA | LASER | WATERJET | AUTOMATION | SOFTWARE | CONSUMABLES

For more information on Centricut laser products,
visit www.hypertherm.com/laserconsumables
or email ctlaser@hypertherm.com

Hypertherm, Centricut, SilverLine and CoolFlow are trademarks of Hypertherm, Inc., and may be registered in the United States and/or other countries. All other trademarks are the property of their respective owners.

Environmental stewardship is one of Hypertherm's core values, and it is critical to our success and our customers' success. We are striving to reduce the environmental impact of everything we do. For more information: www.hypertherm.com/environment.



© 1/2019 Hypertherm, Inc. Revision 8
880480

Hypertherm[®]
SHAPING POSSIBILITY[®]

