

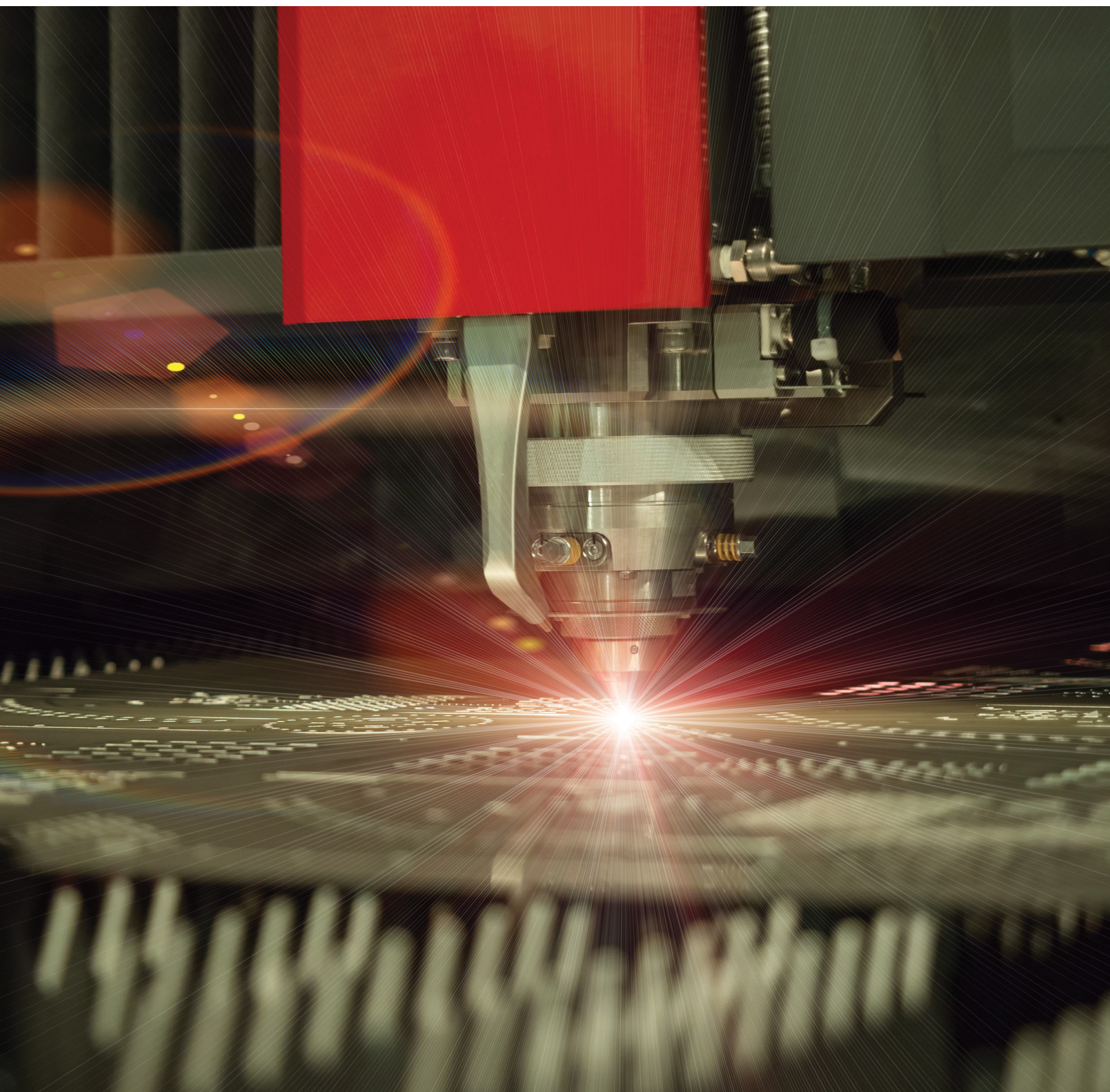

2019 catalog

For CO₂ and fiber laser consumables

Replacement parts suitable for Bystronic®



Centricut delivers

- OEM quality nozzles, ceramics and optics
- Technical and application support from our OEM-trained technicians
- 100% satisfaction guarantee

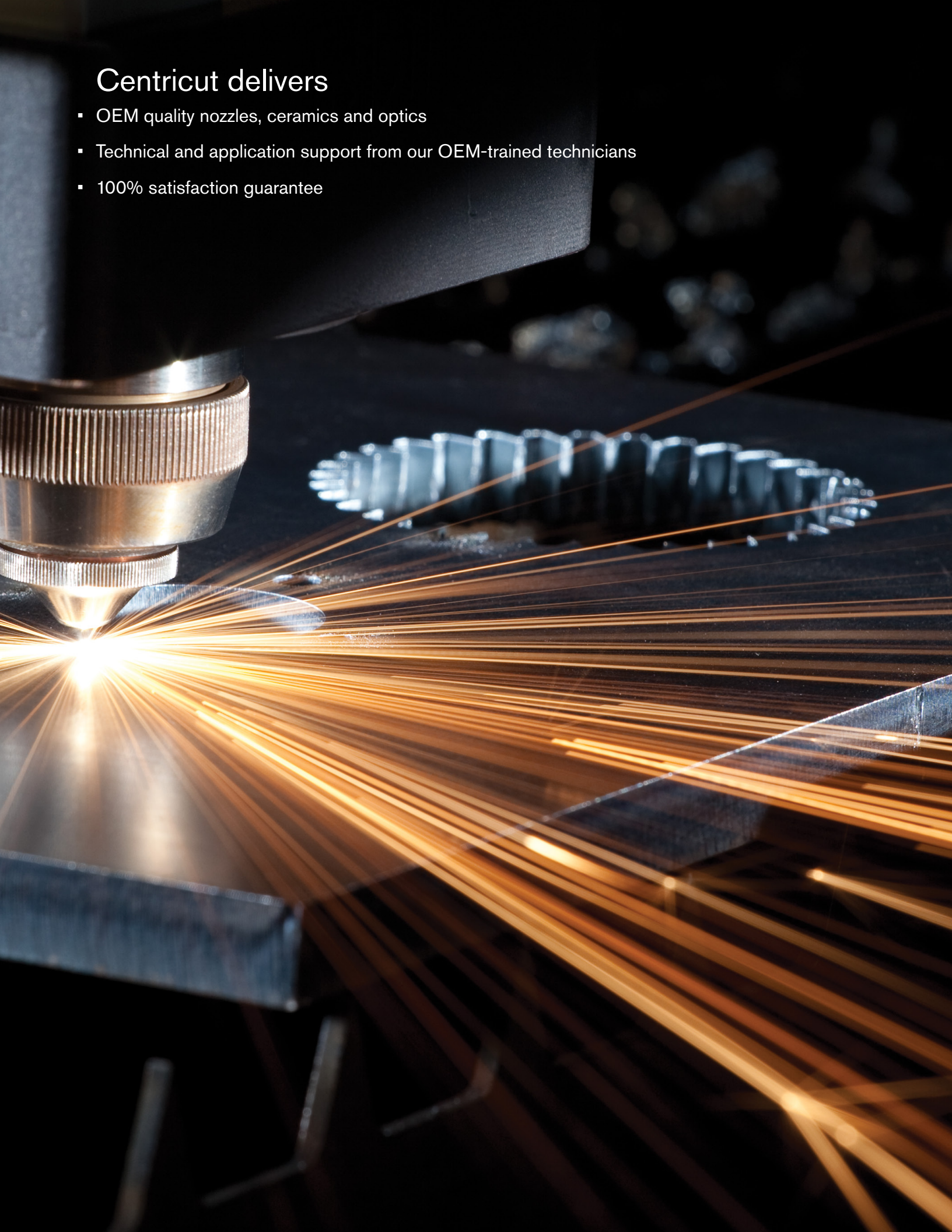

CO₂ and fiber laser nozzles

Nozzle options

All Centricut nozzles are engineered and manufactured to the highest standards. Select the OEM quality nozzle best suited for your application needs

Copper

Most commonly used nozzle offering good durability and nozzle life. Primary nozzle type for fiber lasers.

Chrome plated

Shiny, mirror-like finish provides increased spatter resistance, improved durability and longer life than copper nozzles. Not recommended for use on fiber lasers.

Look for CP in the part number to identify a chrome plated nozzle

Hard chrome plated

Premium nozzles offering the highest level of durability and longest nozzle life. These nozzles are not as shiny as chrome plated and have a dull appearance. Not recommended for use on fiber lasers.

Look for HCP in the part number to identify a hard chrome nozzle.

CP (chrome plated)	Nozzles plated with chrome for increased durability. These nozzles are easier to clean, resist damage due to 'tip-ups' and have better spatter resistance over non-plated nozzles. For use in all laser cutting applications.
Conical	Conical internal geometry for high pressure, non-ferrous cutting applications using nitrogen, air or argon.
Cylindrical	Cylindrical internal geometry for low pressure, mild steel cutting applications using oxygen.
Double	Insert pressed into a standard cylindrical nozzle for improved edge quality, laminar gas flow and spatter resistance. Primarily used in mild steel applications.
HCP (hard chrome plated)	Enhanced durability chrome plated nozzles. These nozzles are easier to clean, resist damage due to 'tip-ups' and have better spatter resistance over non-plated nozzles. For use in all laser cutting applications.
HP (high pressure) HD (high density)	Conical style nozzle for high pressure, non-ferrous cutting applications using nitrogen, air or argon.
Inner	Also referred to as a 'nozzle insert'. Works in conjunction with an outer nozzle to create a double nozzle. Primarily used in mild steel applications.
Low pressure	Cylindrical style nozzle for low pressure, mild steel cutting applications using oxygen.
Outer	Works in conjunction with an inner nozzle to create a double nozzle. Primarily used in mild steel applications.
Shower	Nozzles with a center orifice surrounded by smaller jets. The smaller jets focus the assist gas into the kerf, creating improved edge quality and the ability to cut thicker material. Primarily used in mild steel applications.

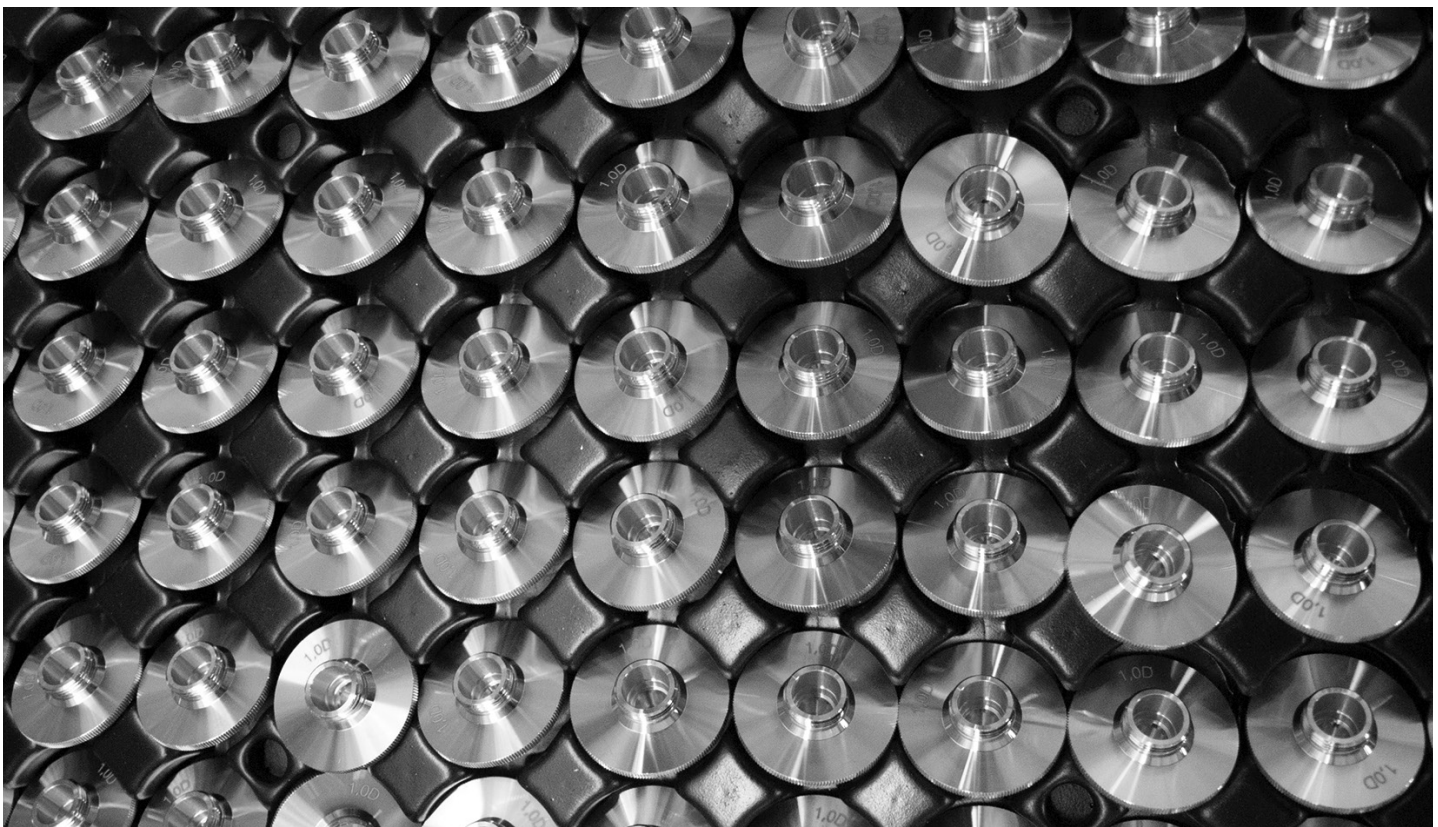

CO₂ and fiber laser optics

Optics key

Lens	
MEN	Meniscus
PLX	Plano-convex
MTD	Mounted
Not MTD	Not mounted
PO	Plano
MP5 or ULA	Ultra low absorption
AR	Anti-reflection
ZNSE	Sinc-selenide
FS	Fused silica
DIA	Diameter
FL	Focal length
ET	Edge thickness
WD	Working distance

How to handle optics

Follow these easy steps, when cleaning or changing your optic, to help maximize the life and performance of your lens

- Avoid touching coated surfaces of the lens and hold the optic by its sides
- Wear powder-free finger cots or latex gloves when handling
- Do not use any tools or sharp objects when handling the optic or when removing it from its packaging
- Ensure the work surface is clean and free of oils, grease and dirt
- Do not place the optic on hard surfaces as they scratch easily
- Once the optic has been unpacked, carefully place it on the lens tissue in which it was originally wrapped

Optics disposal

It is important to dispose of used laser optics at a licensed industrial waste facility which is in compliance with all local, state, and federal regulations. If you don't have access to a licensed industrial waste facility, and purchased your laser optics through Centricut, you may return them to Centricut for proper disposal. This service is only available to Centricut customers.

All optics returned to Centricut must:

- Include return authorization and invoice numbers
- Be sealed in a plastic bag to minimize any hazards
- Remove excess ZnSe powder prior to sealing

*Acceptance of goods will be refused if not packaged correctly or if the return authorization number isn't included



Centricut part number	Reference number	Type	Material	Diameter	Focal length	Edge thickness
Fiber laser lens						
NT375-7955		PLX	FS	30 mm	123 mm	3.82 mm
TR300-9799		PLX	FS	30 mm	146 mm	8.0 mm
TR300-3107		PLX	FS	40 mm	150 mm	8.0 mm
AM313-0238	7710238, 71565737	PLX	FS	50.8 mm	190 mm	11.4 mm
SA384-0022	316-301-0022, 970128	PLX	FS	25.4 mm	200 mm	6.35 mm
SA384-0026	316-301-0026, ESTFLO2119	PLX	FS	38.1 mm	210 mm	6.35 mm
PR361-8988NM	968988, 344631	PLX	FS	1.5"	5.0"	.280"
PR361-2284	968987, 470321	PLX	FS	1.5"	7.5"	0.28
MB312-8858		PLX	FS	2.0"	7.5"	.45"
PR361-0773	970773/M15-15-B X-SP-7MM	PLX MTD	FS	1.5"	5.0"	.275"
PR361-8988	LH968988PVL, 576.41.005	PLX MTD	FS	1.5"	5.0"	.280"

Centricut part number	Reference number	Material	Diameter	Edge thickness
Fiber laser windows				
PT317-1424	P0588-1022-00001	FS	21.5 mm	2.0 mm
PT317-0589	970397, 6930003260, P0589-360-00002, R26RT006410, R26ZZC90110	FS	22.35 mm	4.0 mm
PT317-9360	6930003260, P0589-360-00001	FS	22.35 mm	4.0 mm
MB312-2336		FS	25.4 mm	4.0 mm
PT317-0010	P0253-1034-00001	FS	30.0 mm	1.5 mm
TR300-6719	766719, P0795-1201-00002	FS	30.0 mm	5.0 mm
SA384-0007	316-304-0007, ESTFLO01407, 632755-117	FS	32.0 mm	6.35 mm
TR300-4767	1614767	FS	34.0 mm	4.9 mm
PR361-0089	1057.81000.089	FS	35.0 mm	1.5 mm
BY314-5746	968752, 10045746, 10-02-01-5511	QTZ	36.0 mm	5.0 mm
PR361-0474	970474	FS	37.0 mm	4.0 mm
PT317-1551	P0595-61551, P0595-58601-61551	FS	37.0 mm	7.0 mm
PT317-1425		FS	38.0 mm	5.2 mm
CN307-3987	913987, 71598028	FS	38.1 mm	1.6 mm
MZ315-5350	Z50SA015350, W495	FS	42.0 mm	9.0 mm
PT317-5919	77005919	FS	48.0 mm	7.0 mm
PT347-0000	OG Y D50 d2 HII	FS	50.0 mm	2.0 mm
PT317-1789	284.0402, 971789, 717062	FS	50.0 mm	3.18 mm
MB312-0137	633744-137	FS	50.0 mm	8.0 mm
AM313-0026	71570026	FS	OCTAGONAL	1.5 mm

Centricut is not affiliated with the named manufacturers. Reference to machines, parts, descriptions, and model numbers are for convenience in verifying compatibility only. All parts are made by or for Centricut and are not made by the referenced manufacturers (unless expressly indicated). Centricut is a registered trademark of Hypertherm, Inc. All other trademarks are the properties of their respective owners.

Centricut part number	Reference number	Type	Material	Diameter	Focal length	Edge thickness
CO ₂ lenses						
LL342-1819	166634, 61819	MEN	ZNSE	1.1"	5.0"	.236"
TR300-0163	350163, 861143, LMZ1.5-0.29-10.00-2048	MEN	ZNSE	1.5"	10.0"	.290"
TR300-6477	726477	MEN	ZNSE	1.5"	10.0"	.354"
BY314-0185	4-00185, 4-00372, 142375, 60603	MEN	ZNSE	1.5"	3.75"	.236"
TR300-6104	346104, 61962, 831393	MEN	ZNSE	1.5"	3.75"	.290"
BY314-0736	414323, 4-10736	MEN	ZNSE	1.5"	3.75"	.354"
BY314-0186	60260, 507790, 4-00186, 110111	MEN	ZNSE	1.5"	5.0"	.236"
TR300-8114	088114, 60696, 406294, 110109, 61014, 658108, 29100023, 6930001002	MEN	ZNSE	1.5"	5.0"	.290"
BY314-5094	767963, 60615, 4-05094, 110113, 358186, 62710	MEN	ZNSE	1.5"	5.0"	.354"
PR361-0004	62709, 621644, 120216	MEN	ZNSE	1.5"	5.0"	.354"
PT317-0001	61851, 312370	MEN	ZNSE	1.5"	7.5"	.125"
BY314-0187	784964, 60602, 4-00187, 110112	MEN	ZNSE	1.5"	7.5"	.236"
TR300-7517	097517, 60697, 702232, 110110, 61983	MEN	ZNSE	1.5"	7.5"	.290"
LL342-1171	61171	MEN	ZNSE	1.5"	7.5"	.310"
BY314-5095	60616, 4-05095, 570721, 110114, 361129	MEN	ZNSE	1.5"	7.5"	.354"
BY314-8637	698637	MEN	ZNSE	1.5"	7.5"	.354"
TR300-1972	61961, 141972, 977976	MEN	ZNSE	1.5"	8.85"	.290"
TR300-8123	518123	MEN	ZNSE	1.575"	6.102"	.295"
LV333-0176	480176, 29100115	MEN	ZNSE	1.75"	5.0"	.354"
LV333-1551	981551, LMZ2.0-0.380-10.0-2053, 29100061S	MEN	ZNSE	2.0"	10.0"	.380"
PT317-6326	206326	MEN	ZNSE	2.0"	5.0"	.378"
LV333-1004	458138, LMZ2.0-0.380-5.00-2051, PLLMZ0024, 29100154	MEN	ZNSE	2.0"	5.0"	.380"
CN307-2376	61405, 695399, 922376, 232771, 60698, 29100055	MEN	ZNSE	2.0"	7.5"	.380"
AM313-0305	61161, 81140305, LPCZ-1.10-0.16-5.0-1044, PLLPZ0132, 561067	PLX	ZNSE	1.1"	5.0"	.160"
AM313-6602	726602	PLX	ZNSE	1.1"	7.5"	.160"
AM313-0657	600657, 71502030, LPCZ-1.5-0.30-10.0-1128	PLX	ZNSE	1.5"	10.0"	.300"
TK374-2235	312235	PLX	ZNSE	1.5"	12.5"	.300"
PT317-8950	148950	PLX	ZNSE	1.5"	2.5"	.085"
MZ315-0130	60830, Z50MB000130, 962834, 766479	PLX	ZNSE	1.5"	5.0"	.118"
TR300-0002	61163, LMZ1.5-0.16-5.00-2043, 706491, 907557, PLCZ-1.5-0.16-5.0-1116	PLX	ZNSE	1.5"	5.0"	.160"
MZ315-0160	60770, 227092, Z50MB000130H, LPCZ-1.5-0.236-5.0-1122, 834-319-002	PLX	ZNSE	1.5"	5.0"	.236"
PR361-9011	834-319-011, 60905, 658108, ZC15500300, Z50MB000400, 578662, MLL00016	PLX	ZNSE	1.5"	5.0"	.300"
MB312-500	W500, 60905, 110144, LPCZ-1.5-0.30-5.0-1125, PLLPZ0132	PLX	ZNSE	1.5"	5.0"	.310"
CN307-8085	941031, 61001, 908085, ZC15513280, 110092, PLLPZ0033	PLX	ZNSE	1.5"	5.0"WD	.280"
PR361-0003	60784, LPCZ-1.5-0.236-7.5-1123	PLX	ZNSE	1.5"	7.5"	.236"
PR361-9012	834-319-012, 60906, 618938, 306068, 741363, 60882, 299133, 71501070NM, 62649	PLX	ZNSE	1.5"	7.5"	.300"
MB312-018	60906, W018, 383862, 60906LA, W018, 62649ULA, 383862, 62649LA	PLX	ZNSE	1.5"	7.5"	.310"
CN307-9484	909484, 61002, 464497, 100096, LPCZ-1.5-0.280-5.13-1007, PLLPZ0052	PLX	ZNSE	1.5"	7.5"WD	.280"
PT317-8275	628275, W502A, 630736-117	PLX	ZNSE	2.0"	10.0"	.310"
PT317-0537	960537	PLX	ZNSE	2.0"	10.0"	.380"
CN307-4498	154498, 926274	PLX	ZNSE	2.0"	10.0"WD	.380"
TK374-7338	197338	PLX	ZNSE	2.0"	11.25"	.310"
MZ315-5980	145980	PLX	ZNSE	2.0"	5.0"	.300"
MB312-505	W505, 110169, PLLPZ0162, 304725, 61003, Z50ZZ005160	PLX	ZNSE	2.0"	5.0"	.310"
MZ315-0516A	61019, Z50ZZ00516A, Z50ZZ013480, 81140307, 741363	PLX	ZNSE	2.0"	5.0"	.380"

Centricut is not affiliated with the named manufacturers. Reference to machines, parts, descriptions, and model numbers are for convenience in verifying compatibility only. All parts are made by or for Centricut and are not made by the referenced manufacturers (unless expressly indicated). Centricut is a registered trademark of Hypertherm, Inc. All other trademarks are the properties of their respective owners.

Centricut part number	Reference number	Type	Material	Diameter	Focal length	Edge thickness
CO ₂ lenses (continued)						
CN307-0676	870676, 61514, LPCZ-2.0-0.38-5.19-1141, PLLPZ0116	PLX	ZNSE	2.0"	5.0"WD	.380"
NT375-4494	634494, LPCZ-2.0-0.30-7.5-1133	PLX	ZNSE	2.0"	7.5"	.300"
MB312-510	W510, 61004, 892020, 110122, PLLPZ0138	PLX	ZNSE	2.0"	7.5"	.310"
MZ315-0520A	61405, 232771, Z50ZZ00520A, MLL00018, Z50ZZ005200, Z50ZZ013470, 81140186	PLX	ZNSE	2.0"	7.5"	.380"
CN307-1603	61515, 781603, LPCZ-2.0-0.38-7.67-1143, PLLPZ0115	PLX	ZNSE	2.0"	7.5" WD	.380"
TK374-3478	541344, 263478, Z50ZZ00530A, LPCZ-2.0-0.31-7.45-1137	PLX	ZNSE	2.0"	8.75"	.310"
TK374-6670	236670, 61690, Z50ZZ00550A	PLX	ZNSE	2.5"	10.0"	.390"
TK374-1592	178937	PLX	ZNSE	2.5"	11.25"	.310"
TK374-8593	828593	PLX	ZNSE	2.5"	12.5"	.390"
TK374-3827	243827, Z50ZZ00540A, LPCZ-2.5-0.31-8.75-1145	PLX	ZNSE	2.5"	8.75"	.310"
AM313-0221	81140221, 6067639	PLX MTD	ZNSE	1.5"	3.75"	.300"
AM313-0306	81140306, 65024, 578662/M16-15-1C-P5.0, PLLPZ0133, 6874793	PLX MTD	ZNSE	1.5"	5.0"	.300"
AM313-1216	578662/M20-15-1C-P5.0, 9001216A, 71501072, 7973109, 6360374	PLX MTD	ZNSE	1.5"	5.0"	.300"
AM313-8662	578662/M21-15-1C-P5.0, 6060415	PLX MTD	ZNSE	1.5"	5.0"	.300"
AM313-9830	65101, 578662, 6547252	PLX MTD	ZNSE	1.5"	5.0"	.300"
AM313-1215	9001215A, 306068/M21-15-1C-P7.5, 7973110, 71501070, 6395647	PLX MTD	ZNSE	1.5"	7.5"	.300"
AM313-9831	71369831, 65102, 6550214	PLX MTD	ZNSE	1.5"	7.5"	.300"
AM313-10F1	680154-001, 71710061, 6021844	PLX MTD	ZNSE	2.0"	10.0"	.380"
AM313-0307	65035, 81140307, 741363, 6068456	PLX MTD	ZNSE	2.0"	5.0"	.380"
AM313-50F1	71710059, 741363M30-20-1C-P5.0, 6296946	PLX MTD	ZNSE	2.0"	5.0"	.380"
AM313-0400	306068, 65025, 81140400, 6022704	PLX MTD	ZNSE	2.0"	7.5"	.300"
AM313-0186	65038, 81140186, PLLPZ0156, 6068413	PLX MTD	ZNSE	2.0"	7.5"	.380"
AM313-75F1	232771M31-20-1C-P7.5, 71710030, 6243925	PLX MTD	ZNSE	2.0"	7.5"	.380"
BY314-7014MP5	460386, 4-07014	MEN	ZNSE MP5	1.5"	10.0"	.354"
BY314-0186MP5	4-00186, 528717, 60260LA	MEN	ZNSE MP5	1.5"	5.0"	.236"
TR300-8114MP5	60696LA, 312503, 29100023, 88114, PLLPZ0125B	MEN	ZNSE MP5	1.5"	5.0"	.290"
BY314-5094MP5	123397, 4-07475, 60615LA, LMZ1.5-0.354-5.0-2008	MEN	ZNSE MP5	1.5"	5.0"	.354"
BY314-0187MP5	714512, 60602LA, 4-00187	MEN	ZNSE MP5	1.5"	7.5"	.236"
TR300-7517MP5	60697LA, 97517, 474644, PLLPZ0126B	MEN	ZNSE MP5	1.5"	7.5"	.290"
BY314-5095MP5	602033, 60616LA, 4-07476, LMZ1.5-0.354-7.5-2009, PLLPZ0130B, 62710	MEN	ZNSE MP5	1.5"	7.5"	.354"
BY314-8294MP5	996707, 10048294	MEN	ZNSE MP5	1.5"	9.0"	.354"
HW405-4913	114913	MEN	ZNSE MP5	2.0"	10.0"	.379"
HW405-5270	355270	MEN	ZNSE MP5	2.0"	5.0"	.378"
HW405-7143	527143, 467572, 60698LA, 291005-5, 308332, PLLM20025B	MEN	ZNSE MP5	2.0"	7.5"	.379"
MZ315-0160MP5	60770LA, 857048, Z50MB000160	PLX	ZNSE MP5	1.5"	5.0"	.236"
MZ315-0400MP5	106106, PLLPZ0132B, 60905LA, Z50MB000400, 62670ULA	PLX	ZNSE MP5	1.5"	5.0"	.300"
CN307-8085MP5	61001LA, 794914, 908085,	PLX	ZNSE MP5	1.5"	5.0"WD	.280"
MB312-018MP5	383862	PLX	ZNSE MP5	1.5"	7.5"	.300"
CN307-9484MP5	PLLPZ0052B	PLX	ZNSE MP5	1.5"	7.5"WD	.315"
MB312-505MP5	61003LA, 922203, W505	PLX	ZNSE MP5	2.0"	5.0"	.310"
AM313-0307NMP5	81140307, 61019LA, 753010	PLX	ZNSE MP5	2.0"	5.0"	.380"
CN307-0211MP5	540211, 61019LA, 922377	PLX	ZNSE MP5	2.0"	5.0"WD	.380"
MB312-510MP5	61004LA, 635061, W510,	PLX	ZNSE MP5	2.0"	7.5"	.310"
CN307-2376MP5	329011, 922376, 61515ULA,	PLX	ZNSE MP5	2.0"	7.5"	.380"
MZ315-0520AMP5	392125, 61405LA, Z50ZZ00520A, PLLPZ0135B, 81140186 61405ULA	PLX	ZNSE MP5	2.0"	7.5"	.380"

Centricut is not affiliated with the named manufacturers. Reference to machines, parts, descriptions, and model numbers are for convenience in verifying compatibility only. All parts are made by or for Centricut and are not made by the referenced manufacturers (unless expressly indicated). Centricut is a registered trademark of Hypertherm, Inc. All other trademarks are the properties of their respective owners.

Centricut part number	Reference number	Type	Material	Diameter	Focal length	Edge thickness
CO ₂ lenses (continued)						
AM313-0306MP5	65024LA, 81140306, 106106, M16-15-1C-P5.0, 6936448	PLX MTD	ZNSE MP5	1.5"	5.0"	.300"
AM313-1216MP5	106106, M20-15-1C-P5.0, 6071896	PLX MTD	ZNSE MP5	1.5"	5.0"	.300"
AM313-9830MP5	71369830, 106106, 65101LA, 106106/M16-15-1C-P5.0-A2-NI-1A	PLX MTD	ZNSE MP5	1.5"	5.0"	.300"
AM313-0400MP5	65025LA, 383862/M16-15-1C-P7.5-A2-NI-1A, 81140400, 383862	PLX MTD	ZNSE MP5	1.5"	7.5"	.300"
AM313-1215MP5	M21-15-1C-P7.5, 383862, 6071853	PLX MTD	ZNSE MP5	1.5"	7.5"	.300"
AM313-9831MP5	65102LA, 71369831, 383862	PLX MTD	ZNSE MP5	1.5"	7.5"	.300"
AM313-0307MP5	81140307, M16-20-1C-P5.0, 753010, 65035LA, 753010M16-20-1C-P5.0	PLX MTD	ZNSE MP5	2.0"	5.0"	.380"
AM313-0186MP5	392125, 65038LA, M16-20-1C-P7.5, 81140186, 6816292	PLX MTD	ZNSE MP5	2.0"	7.5"	.380"

Accessories

Centricut part number	Reference number	Description	Pkg qty
TR300-6452		Lens cleaning Tiffen paper (50 pcs)	1
TR300-1115		Lens cleaning pre-cut cotton (100 pcs)	1
TR300-1010		Dropper, lens cleaning fluid	1
TR300-1112		Optical cleaning fluid	1
TR300-0699	70675699 REVA	Lens cleaning swabs (25 pcs)	1
TR300-7991	27991	Polyester wipes 4" x 4" (100 pcs)	1
TR301-0282		Injector	1
TR300-LSA		Lens stress analyzer	1
TR300-255		Magnifying loop	1
TR300-271		Base, mirror maintenance	1
TR300-7388	787388	Mirror polish .1UM 250ML	1
MZ335-115	AL1115/M	MZ-Wire, Indium .8 mm x 125 mm 1.5" Lens	1
MZ335-120	AL1120/M	MZ-Wire, Indium .8 mm x 160 mm 2.0" Lens	1

Centricut is not affiliated with the named manufacturers. Reference to machines, parts, descriptions, and model numbers are for convenience in verifying compatibility only. All parts are made by or for Centricut and are not made by the referenced manufacturers (unless expressly indicated). Centricut is a registered trademark of Hypertherm, Inc. All other trademarks are the properties of their respective owners.

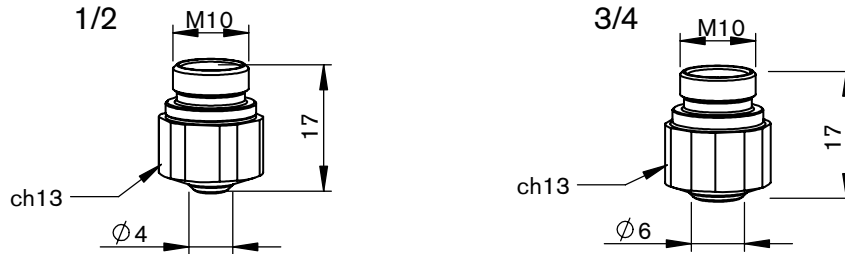
Consumables

	Centricut part number	Esse A part number	Reference number	Description	Pkg qty
1	BY310-4277X	L30674	3-04277, HK08	BY-Nozzle HD, 0.8 mm (10 pk)*	10
	BY310-1910X	L3072	3-01910, HK10	BY-Nozzle HD, 1.0 mm (10 pk)*	10
	BY310-1911X	L30121	3-01911, HK12	BY-Nozzle HD, 1.25 mm (10 pk)*	10
	BY310-1912X	L3073	3-01912, HK15	BY-Nozzle HD, 1.5 mm (10 pk)*	10
	BY310-1913X	L30122	3-01913, HK17	BY-Nozzle HD, 1.75 mm (10 pk)*	10
	BY310-1910CPX	L3072X	3-01910, HK10	BY-Nozzle HD, 1.0 mm CP (10 pk)*	10
	BY310-1911CPX	L30121X	3-01911, HK12	BY-Nozzle HD, 1.25 mm CP (10 pk)*	10
	BY310-1912CPX	L3073X	3-01912, HK15	BY-Nozzle HD, 1.5 mm CP (10 pk)*	10
	BY310-1913CPX	L30122X	3-01913, HK17	BY-Nozzle HD, 1.75 mm CP (10 pk)*	10
2	BY310-4273X	L3083	3-04273, K08	BY-Nozzle, 0.8 mm (10 pk)*	10
	BY310-1905X	L30116	3-01905, K10	BY-Nozzle, 1.0 mm (10 pk)*	10
	BY310-1906X	L30117	3-01906, K12	BY-Nozzle, 1.25 mm (10 pk)*	10
	BY310-1907X	L30118	3-01907, K15	BY-Nozzle, 1.5 mm (10 pk)*	10
	BY310-1908X	L30119	3-01908, K17	BY-Nozzle, 1.75 mm (10 pk)	10
	BY310-1909X	L30120	3-01909, K20	BY-Nozzle, 2.0 mm (10 pk)	10
	BY310-4274X	L30675	3-04274, K25	BY-Nozzle, 2.5 mm (10 pk)	10
	BY310-1905CPX	L30116X	3-01905, K10	BY-Nozzle, 1.0 mm CP (10 pk)	10
	BY310-1906CPX	L30117X	3-01906, K12	BY-Nozzle, 1.25 mm CP (10 pk)	10
	BY310-1907CPX	L30118X	3-01907, K15	BY-Nozzle, 1.5 mm CP (10 pk)	10
3	BY310-1914X	L30123	3-01914, HK20	BY-Nozzle HD, 2.0 mm (10 pk)*	10
	BY310-1915X	L30140	3-03854, HK25	BY-Nozzle HD, 2.5 mm (10 pk)*	10
	BY310-6112X	L30265	3-06112, HK30	BY-Nozzle HD, 3.0 mm (10 pk)*	10
	BY310-0035X	L30700	HK35, 10045748	BY-Nozzle HD, 3.5 mm (10 pk)	10
	BY310-0040X	L30701	HK40	BY-Nozzle HD, 4.0 mm (10 pk)	10
	BY310-1914CPX	L30123X	3-01914, HK20	BY-Nozzle HD, 2.0 mm CP (10 pk)*	10
	BY310-1915CPX	L30140X	3-03854, HK25	BY-Nozzle HD, 2.5 mm CP (10 pk)*	10
	BY310-6112CPX	L30265X	3-06112, HK30	BY-Nozzle HD, 3.0 mm CP (10 pk)*	10
BY310-0040CPX	L30701X	HK40	BY-Nozzle HD, 4.0 mm CP (10 pk)	10	

Centricut is not affiliated with the named manufacturers. Reference to machines, parts, descriptions, and model numbers are for convenience in verifying compatibility only. All parts are made by or for Centricut and are not made by the referenced manufacturers (unless expressly indicated). Centricut is a registered trademark of Hypertherm, Inc. All other trademarks are the properties of their respective owners.

Consumables

	Centricut part number	Esse A part number	Reference number	Description	Pkg qty
	BY310-6058X	L301363	3-16058, NK10-15	BY-Nozzle double, 1.0 mm (10 pk)*	10
	BY310-6059X	L301364	3-16059, NK12-15	BY-Nozzle double, 1.25 mm (10 pk)*	10
	BY310-6060X	L301365	3-16060, NK15-15	BY-Nozzle double, 1.5 mm (10 pk)*	10
	BY310-4317X	L301366	3-14317, NK17-15	BY-Nozzle double, 1.75 mm (10 pk)*	10
	BY310-0005X	L30604	3-14318, NK20-15	BY-Nozzle double, 2.0 mm (10 pk)*	10
	BY310-0006X	L30605	3-14319, NK25-15	BY-Nozzle double, 2.5 mm (10 pk)*	10
	BY310-6256X	L30612	3-16256, NK25-20	BY-Nozzle double, 2.5 mm/Inner 2.0 mm (10 pk)*	10
	BY310-6061X	L30613	3-16061, NK30-17	BY-Nozzle double, 3.0 mm/Inner 1.75 mm (10 pk)*	10
	BY310-0007X	L30606	3-16257, NK30-20	BY-Nozzle double, 3.0 mm (10 pk)*	10
4	BY310-3530X	L30607	NK35-30	BY-Nozzle double, 3.5 mm/Inner 3.0 mm (10 pk)*	10
	BY310-6058CPX	L301363X	3-16058, NK10-15	BY-Nozzle double, 1.0 mm CP (10 pk)	10
	BY310-6059CPX	L301364X	3-16059, NK12-15	BY-Nozzle double, 1.25 mm CP (10 pk)*	10
	BY310-6060CPX	L301365X	3-16060, NK15-15	BY-Nozzle double, 1.5 mm CP (10 pk)	10
	BY310-4317CPX	L301366X	3-14317, NK17-15	BY-Nozzle double, 1.75 mm CP (10 pk)	10
	BY310-0005CPX	L30604X	3-14318, NK20-15	BY-Nozzle double, 2.0 mm CP (10 pk)	10
	BY310-0006CPX	L30605X	3-14319, NK25-15	BY-Nozzle double, 2.5 mm CP (10 pk)	10
	BY310-6256CPX	L30612X	3-16256, NK25-20	BY-Nozzle double, 2.5 mm/Inner 2.0 mm CP (10 pk)*	10
	BY310-6061CPX	L30613X	3-16061, NK30-17	BY-Nozzle double, 3.0 mm/Inner 1.75 mm CP (10 pk)	10
	BY310-0007CPX	L30606X	3-16257, NK30-20	BY-Nozzle double, 3.0 mm CP (10 pk)	10
	BY310-3530CPX	L30607X	NK35-30	BY-Nozzle double, 3.5 mm/Inner 3.0 mm CP (10 pk)	10

* Centricut parts available in single packs. To order single packs, remove the 'X' at the end of the part number (e.g. AM123-4567X would be AM123-4567).
For Esse A parts available in single packs. To order single packs, remove the '30' after the L in the part number (e.g. L301401X would be L401X).
For nozzle bodies and associated parts see pages 28–30.

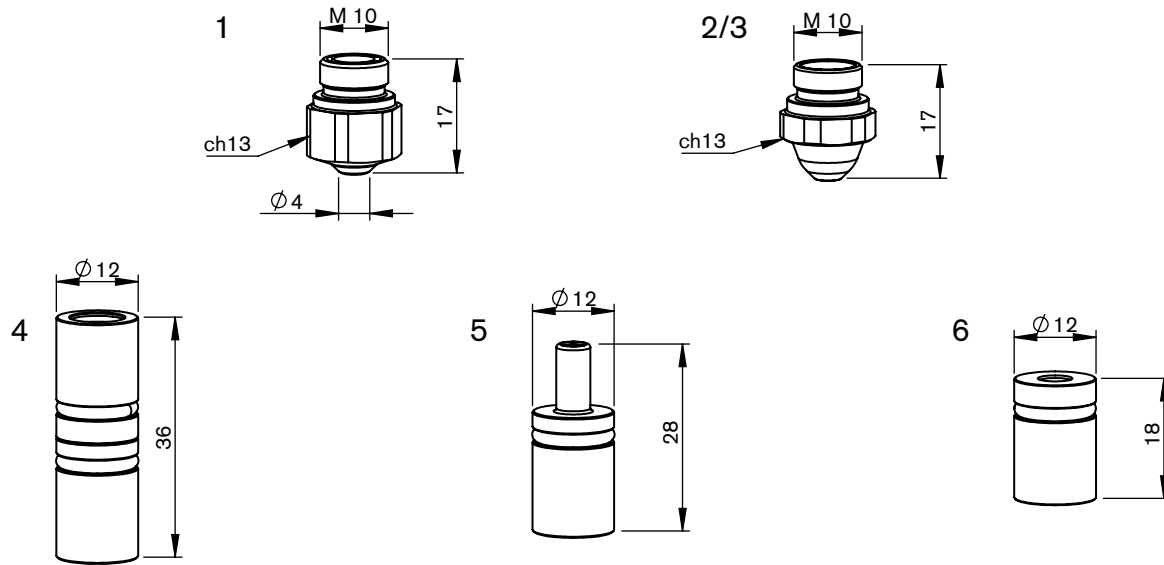
Consumables

	Centricut part number	Esse A part number	Reference number	Description	Pkg qty
1	BY310-0001X	L30600	3-16058, NK10-15	BY-Nozzle double, 1.0 mm (10 pk)	10
	BY310-0002X	L30601	3-16059, NK12-15	BY-Nozzle double, 1.25 mm (10 pk)*	10
	BY310-0003X	L30602	3-16060, NK15-15	BY-Nozzle double, 1.5 mm (10 pk)*	10
	BY310-0004X	L30603	3-14317, NK17-15	BY-Nozzle double, 1.75 mm (10 pk)*	10
	BY310-0001CPX	L30600X	3-16058, NK10-15	BY-Nozzle double, 1.0 mm CP (10 pk)*	10
	BY310-0002CPX	L30601X	3-16059, NK12-15	BY-Nozzle double, 1.25 mm CP (10 pk)*	10
	BY310-0003CPX	L30602X	3-16060, NK15-15	BY-Nozzle double, 1.5 mm CP (10 pk)*	10
	BY310-0004CPX	L30603X	3-14317, NK17-15	BY-Nozzle double, 1.75 mm CP (10 pk)*	10
2	BY319-1894X	L3098	3-01894, 10	BY-Nozzle, 1.0 mm (10 pk)	10
	BY319-1895X	L3099	3-01895, 12	BY-Nozzle, 1.25 mm (10 pk)	10
	BY319-1897X	L30101	3-01897, 17	BY-Nozzle, 1.75 mm (10 pk)	10
	BY319-1898X	L30102	3-01898, 20	BY-Nozzle, 2.0 mm (10 pk)	10
	BY319-4272X	L30676	3-04272, 25	BY-Nozzle, 2.5 mm (10 pk)	10
	BY319-4275X	L30673	3-04275, H08	BY-Nozzle HD, 0.8 mm (10 pk)	10
	BY319-1899X	L3088	3-01899, H10	BY-Nozzle HD, 1.0 mm (10 pk)*	10
	BY319-1900X	L30103	3-01900, H12	BY-Nozzle HD, 1.25 mm (10 pk)	10
	BY319-1901X	L30104	3-01901, H15	BY-Nozzle HD, 1.5 mm (10 pk)*	10
	BY319-1902X	L30105	3-01902, H17	BY-Nozzle HD, 1.75 mm (10 pk)*	10
	BY319-1903X	L30106	3-01903, H20	BY-Nozzle HD, 2.0 mm (10 pk)*	10
	BY319-4276X	L30677	3-04276, H25	BY-Nozzle HD, 2.5 mm (10 pk)*	10
	BY319-0030X	L30679	H30	BY-Nozzle HD, 3.0 mm (10 pk)	10
	BY319-1899CPX	L3088X	3-01899, H10	BY-Nozzle HD, 1.0 mm CP (10 pk)	10
	BY319-0900CPX	L30103X	3-01900, H12	BY-Nozzle HD, 1.25 mm CP (10 pk)	10
	BY319-4276CPX	L30677X	3-04276, H25	BY-Nozzle HD, 2.5 mm CP (10 pk)	10
BY319-0030CPX	L30679X	H30	BY-Nozzle HD, 3.0 mm CP (10 pk)	10	
3	BY319-1215X	L301251	N12-15	BY-Nozzle double, 1.25 mm (10 pk)	10
	BY319-1515X	L301252	N15-15	BY-Nozzle double, 1.5 mm (10 pk)	10
	BY319-1715X	L301253	N17-15	BY-Nozzle double, 1.75 mm (10 pk)	10
	BY319-2015X	L301254	N20-15	BY-Nozzle double, 2.0 mm (10 pk)	10
	BY319-2515X	L301255	N25-15	BY-Nozzle double, 2.5 mm (10 pk)	10
	BY319-2520X	L301256	N25-20	BY-Nozzle double, 2.5 mm (10 pk)	10
	BY319-3020X	L301258	N30-20	BY-Nozzle double, 3.0 mm (10 pk)	10
4	BY327-3210	AL418	7023207, 7023208	BY-Water connector set	1
5	BY328-3207	AL416	7023207	BY-Water connector, male	1
6	BY328-3208	AL417	7023208	BY-Water connector, female	1

* Centricut parts available in single packs. To order single packs, remove the 'X' at the end of the part number (e.g. AM123-4567X would be AM123-4567).

For Esse A parts available in single packs. To order single packs, remove the '30' after the L in the part number (e.g. L301401X would be L401X).

For nozzle bodies and associated parts see pages 28-30.

Centricut is not affiliated with the named manufacturers. Reference to machines, parts, descriptions, and model numbers are for convenience in verifying compatibility only. All parts are made by or for Centricut and are not made by the referenced manufacturers (unless expressly indicated). Centricut is a registered trademark of Hypertherm, Inc. All other trademarks are the properties of their respective owners.

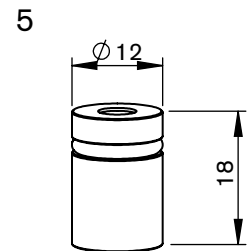
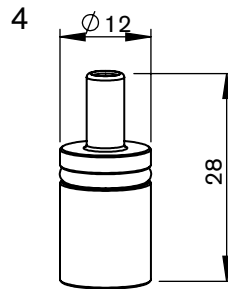
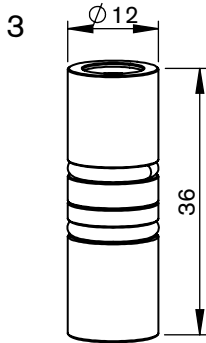
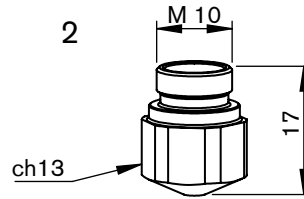
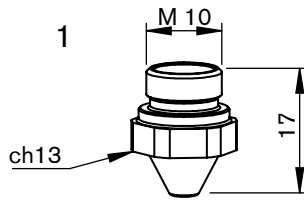

Consumables

	Centricut part number	Esse A part number	Reference number	Description	Pkg qty
1	BY318-1894X	L3014	3-01894, 10	BY-Nozzle, 1.0 mm (10 pk)	10
	BY318-1895X	L3041	3-01895, 12	BY-Nozzle, 1.25 mm (10 pk)	10
	BY318-1896X	L3017	3-01896, 15	BY-Nozzle, 1.5 mm (10 pk)	10
	BY318-1897X	L3042	3-01897, 17	BY-Nozzle, 1.75 mm (10 pk)	10
	BY318-1899X	L3043	3-01899, H10	BY-Nozzle HD, 1.0 mm (10 pk)	10
	BY318-1900X	L3016	3-01900, H12	BY-Nozzle HD, 1.25 mm (10 pk)	10
	BY318-1901X	L3044	3-01901, H15	BY-Nozzle HD, 1.5 mm (10 pk)*	10
	BY318-1902X	L3045	3-01902, H17	BY-Nozzle HD, 1.75 mm (10 pk)	10
	BY318-1903X	L3046	3-01903, H20	BY-Nozzle HD, 2.0 mm (10 pk)*	10
2	BY320-1905X	L30107	3-01905, K10	BY-Nozzle, 1.0 mm (10 pk)	10
	BY320-1906X	L30108	3-01906, K12	BY-Nozzle, 1.25 mm (10 pk)	10
	BY320-1907X	L30109	3-01907, K15	BY-Nozzle, 1.5 mm (10 pk)	10
	BY320-1910X	L3089	3-01910, HK10	BY-Nozzle HD, 1.0 mm (10 pk)*	10
	BY320-1911X	L30112	3-01911, HK12	BY-Nozzle HD, 1.25 mm (10 pk)*	10
	BY320-1912X	L30113	3-01912, HK15	BY-Nozzle HD, 1.5 mm (10 pk)*	10
	BY320-1913X	L30114	3-01913, HK17	BY-Nozzle HD, 1.75 mm (10 pk)*	10
	BY320-1914X	L30115	3-01914, HK20	BY-Nozzle HD, 2.0 mm (10 pk)*	10
3	BY327-3210	AL418	7023207, 7023208	BY-Water connector set	1
4	BY328-3207	AL416	7023207	BY-Water connector, male	1
5	BY328-3208	AL417	7023208	BY-Water connector, female	1

* Centricut parts available in single packs. To order single packs, remove the 'X' at the end of the part number (e.g. AM123-4567X would be AM123-4567).
For Esse A parts available in single packs. To order single packs, remove the '30' after the L in the part number (e.g. L301401X would be L401X).
For nozzle bodies and associated parts see pages 28-30.

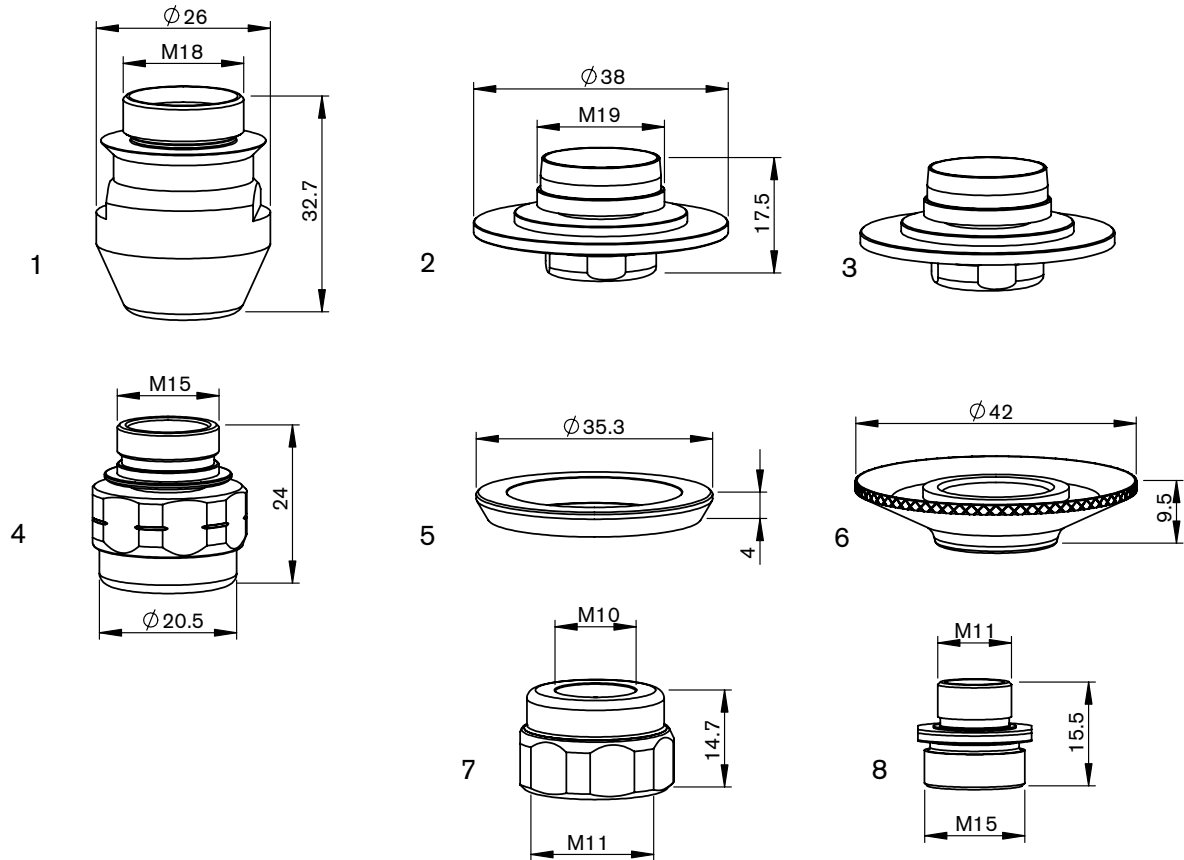
Consumables

	Centricut part number	Esse A part number	Reference number	Description	Pkg qty
1	BY328-4061	AL450	10034061	BY-Nozzle holder	1
2	BY328-6030	AL451	10046030	BY-Nozzle adapter	1
3	BY328-1133	AL452	10051133	BY-Nozzle adapter MSB	1
4	BY328-4099	AL449	10064099	BY-Nozzle body	1
5	BY328-9016	AL441	10046025	BY-Isolator ring, ceramic	1
6	BY310-0398	AL398		BY-CL nut	1
7	BY310-1494 NEW	AL454	10071494, 10083331	BY-Nozzle body threaded	1
8	BY310-5057 NEW	AL453	10075057	BY-Breakaway	1

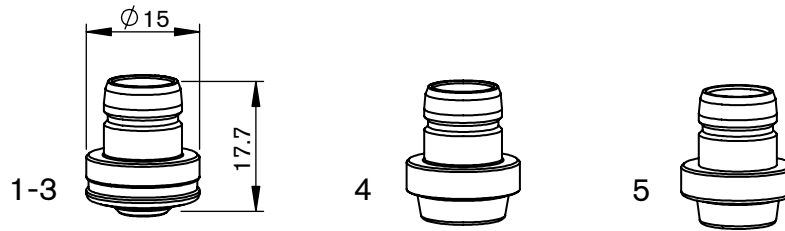

Consumables

	Centricut part number	Esse A part number	Reference number	Description	Pkg qty
1	BY310-8529X	L301660	10048529, HK08	BY-Nozzle, Push Fit 0.8 mm (10 pk)	10
	BY310-5266X	L301661	10035266, HK10	BY-Nozzle, Push Fit 1.0 mm (10 pk)	10
	BY310-5267X	L301662	10035267, HK12	BY-Nozzle, Push Fit 1.2 mm (10 pk)	10
	BY310-5268X	L301663	10035268, HK15	BY-Nozzle, Push Fit 1.5 mm (10 pk)	10
	BY310-5269X	L301664	10035269, HK17	BY-Nozzle, Push Fit 1.7 mm (10 pk)	10
	BY310-5270X	L301665	10035270, HK20	BY-Nozzle, Push Fit 2.0 mm (10 pk)	10
	BY310-5271X	L301666	10035271, HK25	BY-Nozzle, Push Fit 2.5 mm (10 pk)	10
	BY310-5272X	L301667	10035272, HK30	BY-Nozzle, Push Fit 3.0 mm (10 pk)	10
	BY310-9744X	L301668	10049744, HK35	BY-Nozzle, Push Fit 3.5 mm (10 pk)	10
2	BY310-9747X	L301670	10049747, NK10-15	BY-Nozzle double, Push Fit 1.0 mm (10 pk)	10
	BY310-5275X	L301671	10035275, NK12-15	BY-Nozzle double, Push Fit 1.2 mm (10 pk)*	10
	BY310-5278X	L301672	10035278, NK15-15	BY-Nozzle double, Push Fit 1.5 mm (10 pk)*	10
	BY310-5290X	L301673	10035290, NK17-15	BY-Nozzle double, Push Fit 1.7 mm (10 pk)	10
	BY310-5292X	L301674	10035292, NK20-15	BY-Nozzle double, Push Fit 2.0 mm (10 pk)	10
	BY310-5294X	L301675	10035294, NK25-15	BY-Nozzle double, Push Fit 2.5 mm (10 pk)	10
	BY310-5296X	L301676	10035296, NK25-20	BY-Nozzle double, Push Fit 2.5 mm/Inner 2.0 mm (10 pk)	10
	BY310-5298X	L301677	10035298, NK30-17	BY-Nozzle double, Push Fit 3.0 mm/Inner 1.7 mm (10 pk)	10
	BY310-5301X	L301678	10035301, NK30-20	BY-Nozzle double, Push Fit 3.0 mm (10 pk)	10
	BY310-5302X	L301679	10035303, NK35-30	BY-Nozzle double, Push Fit 3.5 mm (10 pk)	10
	BY310-8946X	L301680	10068496, NK35-17	BY-Nozzle double, Push Fit 3.5 mm (10 pk)*	10
BY310-8948X	L301681	10068496, NK40-17	BY-Nozzle double, Push Fit 4.0 mm (10 pk)*	10	
3	BY310-1682	L1682	10039202	BY-Nozzle centering, 2.0 mm	1
4	BY310-6332CP	L1683XH	10066332,35H	BY-Nozzle, 3.5 mm CP	1
	BY310-8494CP	L1684XH	10068494,50H	BY-Nozzle, 5.0 mm CP	1
5	BY310-4700X	L302170	10084700	BY-Nozzle F20 DW, Push Fit 2.0 mm (10 pk)	10
	BY310-4701X	L302171	10084701	BY-Nozzle F25 DW, Push Fit 2.5 mm (10 pk)	10
	BY310-6333X	L302172	10066333	BY-Nozzle F30 DW, Push Fit 3.0 mm (10 pk)	10
	BY310-0091X	L302173	10090091	BY-Nozzle F35 DW, Push Fit 3.5 mm (10 pk)	10
	BY310-6331X	L302174	10066331	BY-Nozzle F40 DW, Push Fit 4.0 mm (10 pk)	10
	BY310-6330X	L302175	10066330	BY-Nozzle F45 DW, Push Fit 4.5 mm (10 pk)	10
	BY310-0092X	L302176	10060092	BY-Nozzle F50 DW, Push Fit 5.0 mm (10 pk)	10
	BY310-6053X	L302177	10066053	BY-Nozzle F55 DW, Push Fit 5.5 mm (10 pk)	10
	BY310-6069X	L302178	10066069	BY-Nozzle F60 DW, Push Fit 6.0 mm (10 pk)	10
	BY310-4700CPX	L302170X	10084700	BY-Nozzle F20 DW, Push Fit 2.0 mm CP (10 pk)	10
	BY310-4701CPX	L302171X	10084701	BY-Nozzle F25 DW, Push Fit 2.5 mm CP (10 pk)	10
	BY310-6333CPX	L302172X	10066333	BY-Nozzle F30 DW, Push Fit 3.0 mm CP (10 pk)	10
	BY310-0091CPX	L302173X	10090091	BY-Nozzle F35 DW, Push Fit 3.5 mm CP (10 pk)	10
	BY310-6331CPX	L302174X	10066331	BY-Nozzle F40 DW, Push Fit 4.0 mm CP (10 pk)	10
	BY310-6330CPX	L302175X	10066330	BY-Nozzle F45 DW, Push Fit 4.5 mm CP (10 pk)	10
	BY310-0092CPX	L302176X	10060092	BY-Nozzle F50 DW, Push Fit 5.0 mm CP (10 pk)	10
	BY310-6053CPX	L302177X	10066053	BY-Nozzle F55 DW, Push Fit 5.5 mm CP (10 pk)	10
	BY310-6069CPX	L302178X	10066069	BY-Nozzle F60 DW, Push Fit 6.0 mm CP (10 pk)	10

* Centricut parts available in single packs. To order single packs, remove the 'X' at the end of the part number (e.g. AM123-4567X would be AM123-4567).
For Esse A parts available in single packs. To order single packs, remove the '30' after the L in the part number (e.g. L301401X would be L401X).

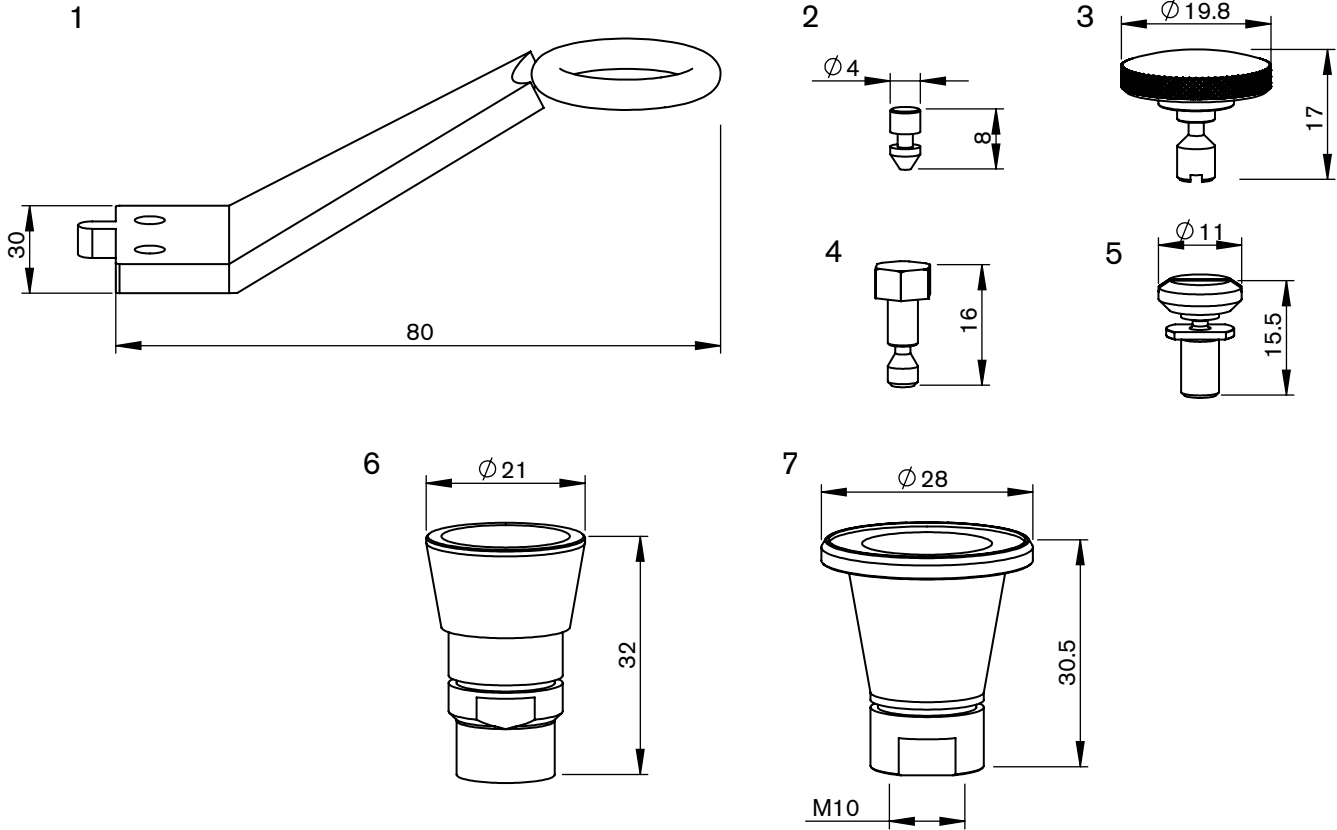

Consumables

	Centricut part number	Esse A part number	Reference number	Description	Pkg qty
1	BY328-2015	AL5	2-01262	BY-Scanner	1
2	BY328-3137	AL24	4-03137	BY-Pin (5 pcs)	5
3	BY328-3136	AL25	4-03136	BY-Knurled screw	1
4	BY328-0324	AL1	4-00324	BY-Knurled screw	1
5	BY328-9001	AL208	3-09001	BY-Cross jet screw	1
6	BY328-2291	AL188	3-02291	BY-Nozzle body	1
7	BY328-5497	AL102	3-05497	BY-Nozzle body, copper	1
	BY328-0236 (not shown)		3140236	BY-O-ring	1
	BY328-0820 (not shown)	AL99	3140820	BY-Lens o-ring	1
	BY328-0004 (not shown)	AL246		BY-Screw kit for BY328-3663-C (3 pcs)	3

Nozzle bodies and associated parts on this page can be used with nozzles on pages 22-25.

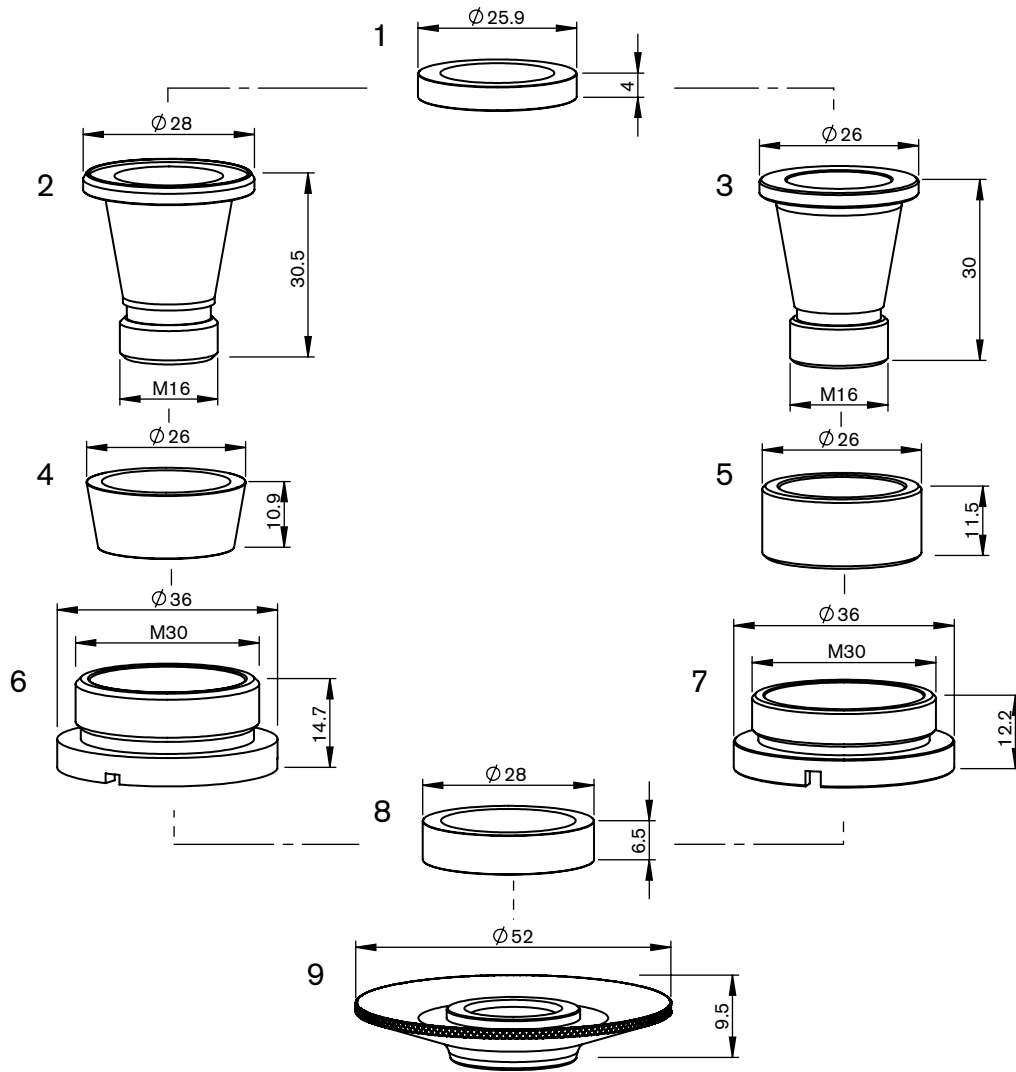

Consumables

	Centricut part number	Esse A part number	Reference number	Description	Pkg qty
1	BY328-1642	AL231	4-01642, 4-00569	BY-Insulating disc ceramic	1
2	BY328-8701	AL172	2-08701	BY-Nozzle body	1
3	BY359-2930	AL423	10032930	BY-Nozzle body	1
4	BY328-1959	AL230	4-01959	BY-Cone ceramic	1
5	BY359-2838	AL425	10032838	BY-Insulating ring ceramic	1
6	BY328-1071	AL174	3-11071	BY-Fastening nut	1
7	BY359-2839	AL424	10032839	BY-Fastening nut	1
8	BY328-9010	AL126	4-09010	BY-Ring ceramic	1
9	BY328-8700	AL173	2-08700	BY-signboard	1
	BY328-0005	AL173X	2-08700	BY-signboard, chrome	1

Nozzle bodies and associated parts on this page can be used with nozzles on pages 22–25.

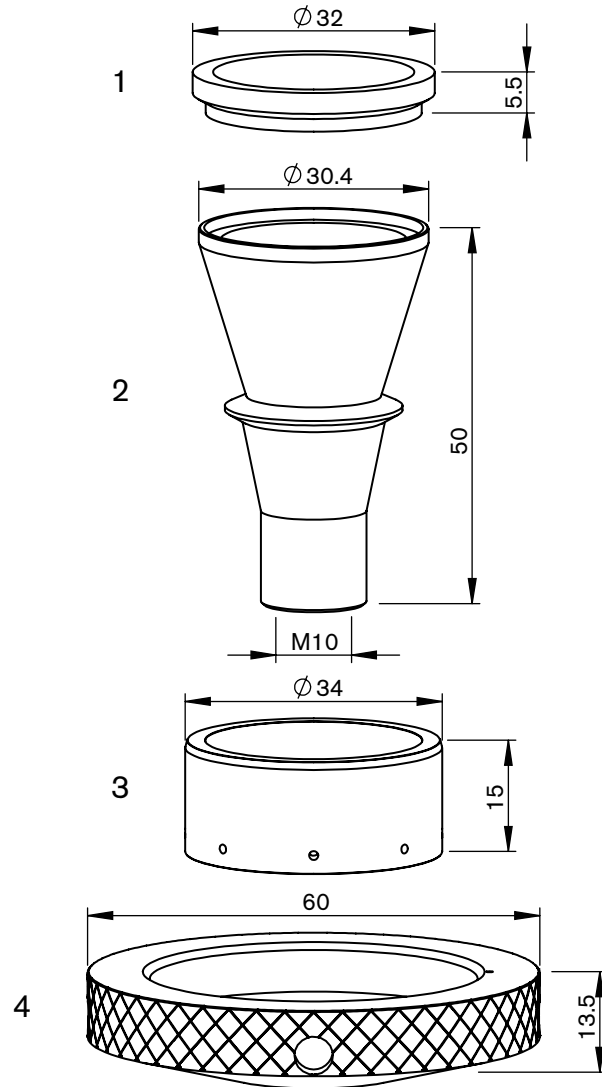
Consumables

	Centricut part number	Esse A part number	Reference number	Description	Pkg qty
1	BY359-3113	AL215	3-13113	BY-Insulating ring, small	1
2	BY359-0837	AL214	2-10837	BY-Nozzle body	1
3	BY359-3422	AL216	3-13422	BY-Insulating ring w/holes, large	1
4	BY359-3110	AL258	3-13110	BY-Shield, copper	1

Nozzle bodies and associated parts on this page can be used with nozzles on pages 22-25.

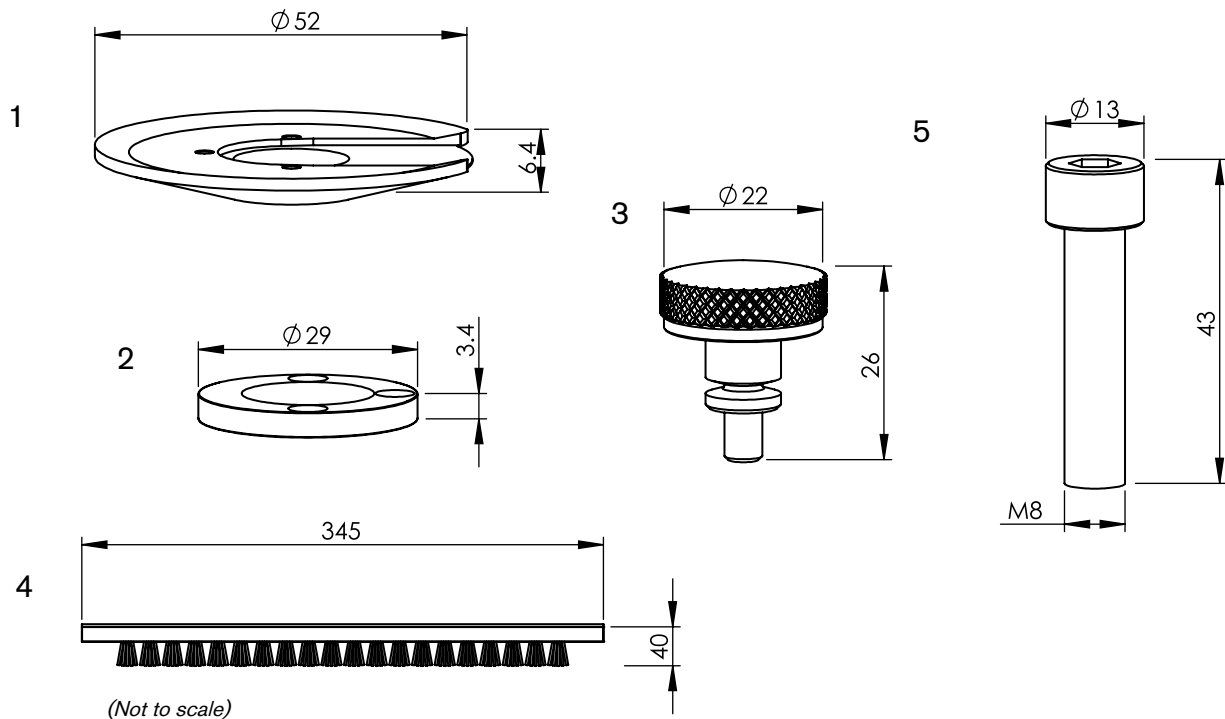

Consumables

	Centricut part number	Esse A part number	Reference number	Description	Pkg qty
1	BY359-6035	AL222	3-06035	BY-Shield, copper only	1
2	BY328-328-1	AL120	3-06035-T	BY-Disc, PTFE*	1
3	BY328-4976	AL209	4-04976	BY-Knurled screw	1
4	BY328-6511	AL300	2-06511	BY-Brush w/screws	1
5	BY328-3884	333884	333884	BY-Screws, plastic (2 pcs)	2
Filters – not shown					
	BY328-0020	7004621	D020	BY-Air filter (Deltec)	1
	BY328-9412L	7509412 - LONG	7509412 - long	BY-Air filter (active coal) long, 190 mm	1

*PolyTetraFluoroEthylene is a fluorocarbon-based polymer and is commonly abbreviated PTFE. The Teflon® brand of PTFE is manufactured only by DuPont and is not sold by Hypertherm. Hypertherm purchases other brands of PTFE from various high quality manufacturers.

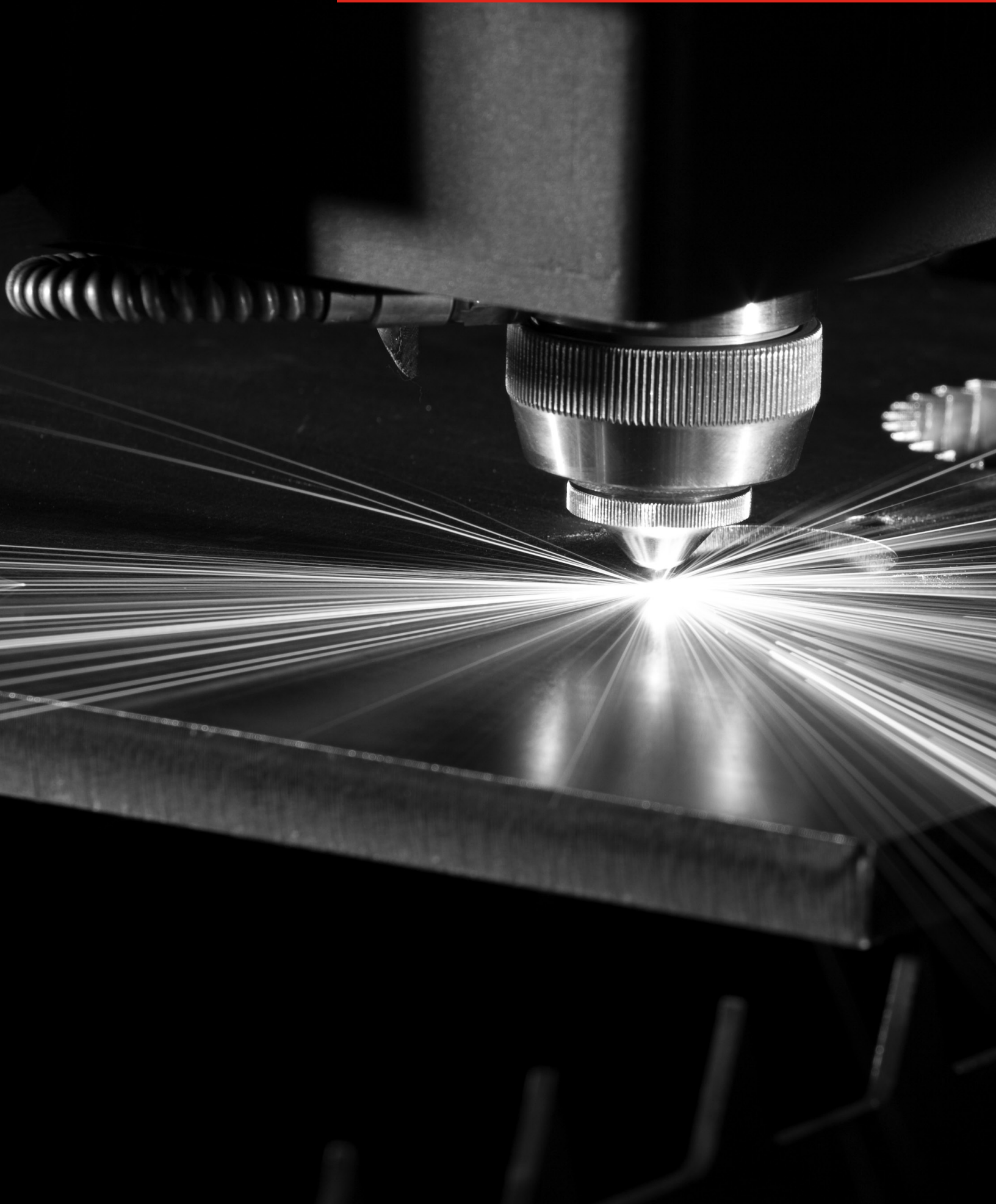

Sensor cones



Centricut sensor cones provide substantial cost savings without sacrificing performance or quality

- Available for Amada, Mazak, Mitsubishi and Precitec
- Delivers the same OEM performance at a lower cost
- Unmatched performance and reliability
- Engineered and manufactured to Hypertherm's precise quality standards
- Backed by our one-year warranty and 100% satisfaction guarantee

Centricut part number	OEM	Reference number	Description
AM343-0091	Amada	71360091	AM-Sensor cone, HS95 mini
AM343-1621*	Amada	71341621	AM-Sensor cone, HS95
AM343-9107	Amada	ECO cone	AM-Sensor cone, ECO
AM343-1690	Amada	71341690	AM-Sensor cone, HS98
AM343-L3015C	Amada	71374509	PT-Sensor cone, LC3015
AM343-4233B*	Amada	71564233	AM-Sensor cone, HPL Black
AM343-4233G*	Amada	71564233	AM-Sensor cone, HPL Gold
PT347-3323	Mazak	HNP	PT-Sensor cone, HNP
MZ335-HNPS*	Mazak	HNPS	MZ-Sensor cone, HNP short version
PT347-0007	Mazak	56743300500	PT-Sensor cone, HNZ (Mazak)
PT347-0011*	Mitsubishi	P0354-110-00002	PT-Sensor cone, HNZ (Mitsubishi)
MB334-W429A	Mitsubishi	P0461-270-00001	MB-Sensor cone, W429A
PT347-0238*	Precitec	BQ930D238G01	PT-Sensor cone, HNZ SMA
PT347-8001	Precitec	P0361-203-00001	PT-Sensor cone, 2.5Z/J
PT347-0522*	Precitec	P0599-520-00002	PT-Sensor cone, LRC
PT347-1145	Precitec	P0380-140-0002, P0380-130-00001, 281145	PT-Sensor cone, DZ

*Sensor cone repair service is available for most sensor cones in North America and select international regions. For more information contact Ctlaser@Hypertherm.com.

Centricut is not affiliated with the named manufacturers. Reference to machines, parts, descriptions, and model numbers are for convenience in verifying compatibility only. All parts are made by or for Centricut and are not made by the referenced manufacturers (unless expressly indicated). Centricut is a registered trademark of Hypertherm, Inc. All other trademarks are the properties of their respective owners.

Armored sensor cables

Centricut armored sensor cables outlast standard OEM cables

- Available for all major brands
- Robust design with extreme temperature rating (900–1200°)
- Longer life reduces downtime and production loss
- Spatter resistant stainless steel armoring
- Reinforced collars and high-quality connector

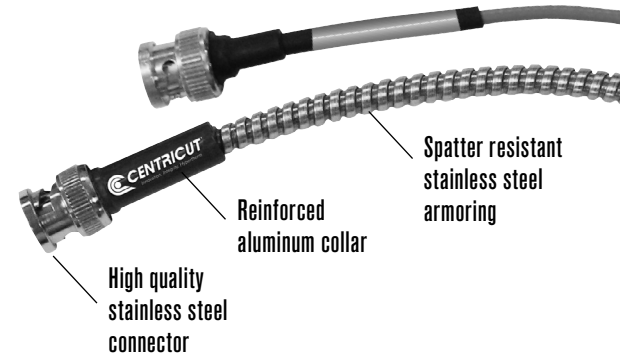

Armored sensor cables

Centricut part number	OEM	Reference number	Description
AM308-8965	Amada	71398965	AM-Sensor cable, 305 mm (12")
AM308-8965A	Amada	71398965	AM-Sensor cable, 305 mm (12") armored
AM313-1901	Amada	71341630	AM-Sensor cable HS-5, 305 mm (12")
AM313-1901A	Amada	71341630	AM-Sensor cable HS-5, 305 mm (12") armored
AM313-8292	Amada	71398292	AM-Sensor cable dual shield, 7 m (275.6")
AM313-9851A	Amada	71369851	AM-Sensor cable, 203 mm (8") armored
CN306-0654A	Cincinnati	909654, 922686	CN-Sensor cable, 114 mm (4.5") armored
CN306-0951A	Cincinnati	842951	CN-Sensor cable, 140 mm (5.5") armored
CN306-2951	Cincinnati	842951, PLTTW0015	CN-Sensor cable, 140 mm (5.5")
CN306-9654	Cincinnati	909654, 922686, PLTTW0002	CN-Sensor cable, 114 mm (4.5")
MZ335-0111A	Mazak	4674330111	MZ-Sensor cable, 280 mm (11") armored
MZ335-0181A	Mazak	46743300181	MZ-Sensor cable, 317.5 mm (12.5") armored
MZ335-1330A	Mazak	46683301330	MZ-Sensor cable, 305 mm (12") armored
MZ335-1980A	Mazak	46683301980	MZ-Sensor cable, 280 mm (11") armored
MZ335-5320	Mazak	6143355320	MZ-Sensor cable, 61.5 mm (2.4") armored
MZ335-630A	Mazak	00BSBA630MNC	MZ-Sensor cable, 630 mm (25") armored
MZ335-8290	Mazak	46143308290	MZ-Sensor cable, 75 mm (3")
NT426-1682	NTC	4R029911-001, J482D	NT-Sensor cable, 216 mm (8.5")
NT426-4991	NTC	3-0104991	NT-Sensor cable 0-0BNC/MCX, 482 mm (19")
NT426-7492	NTC	3-0117492	NT-Sensor cable 90BNC/90BNC, 482 mm (19")
NT426-8677	NTC	4R028677-001	NT-Sensor cable, 508 mm (20") armored
PR361-3150	Prima	820.63.150	PR-Sensor cable, 150 mm (5.9")
PR361-3151	Prima	820.63.150	PR-Sensor cable, 150 mm (6") high profile
PR361-3160	Prima	555.63.150	PR-Sensor cable, 210 mm (8 17/64")
PT347-0101A	Precitec	P0360-100-00500	PT-Sensor cable, 500 mm (20") armored
PT347-0181	Precitec	46743300181	PT-Sensor cable, 305 mm (12") armored
PT347-0250	Precitec	342475	PT-Sensor cable, 250 mm (9.8") armored
PT347-0300A	Precitec	P0492-014-00300	PT-Sensor cable KE, 300 mm (11.8") armored
PT347-0450	Precitec	P0497-002-00450	PT-Sensor cable, 450 mm (17.7")
PT347-KS13	Precitec/ Gunkyo	00BMTKA-A-HS500mm	PT-Sensor cable, 390 mm (15.5") armored
PT347-1250	Precitec	D5001-040-00250	PT-Sensor cable, 250 mm (9.8") armored
TR301-0930	Trumpf	280930	TR-Sensor cable, 152 mm (6") armored
TR301-7833	Trumpf	227833	TR-Sensor cable, 432 mm (17")
TR301-9983	Trumpf	359983, 342474	TR-Sensor cable, 190 mm (7.5") armored

Centricut is not affiliated with the named manufacturers. Reference to machines, parts, descriptions, and model numbers are for convenience in verifying compatibility only. All parts are made by or for Centricut and are not made by the referenced manufacturers (unless expressly indicated). Centricut is a registered trademark of Hypertherm, Inc. All other trademarks are the properties of their respective owners.

Lens cleaning tips



Centricut supplies suitable for all OEM CO₂ and fiber laser lenses

- Lens maintenance base is designed to secure a wide range of optics sizes for the cleaning process
- Centricut optical cleaning fluid is a safe, economical alternative to traditional high-purity and reagent-grade solvents
- Cleaning materials suited for all lens cleaning needs; lens paper, polyester swabs and polyester wipes

Lens paper

Recommended for the routine maintenance cleaning of flat lenses.

Polyester swabs

Recommended for cleaning curved lenses and where a more aggressive cleaning is required (interchangeable with polyester wipes).

Polyester wipes

Recommended for cleaning CO₂ and fiber lenses and windows (interchangeable with polyester swabs and lens paper).

Product description	Part number	Quantity per order
Optical cleaning fluid (3 oz.)	TR300-1112	1
Lens cleaning swab	TR300-0699	25
Lens cleaning paper, Tiffen	TR300-6452	50
Polyester wipes 4" x 4"	TR300-7991	100
Base, lens maintenance	TR300-271	1

Lens paper

Recommended for the routine maintenance cleaning of flat lenses.

You will need:

- Lens maintenance base (lens holder)
- Optical cleaning fluid
- Air bulb
- Lint-free lens paper
- Latex or rubber gloves

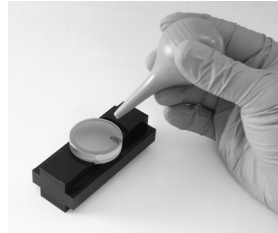

To get started

Using rubber gloves, place the lens in the lens holder and remove all loose contaminants with an air bulb. When contaminants are no longer visible, begin the cleaning process.

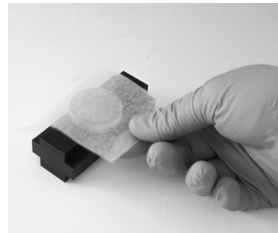

Step 1

Place lens paper over the optic, covering it completely.



Step 2

Apply a couple drops of lens cleaning fluid to the lens paper (far side of the lens).

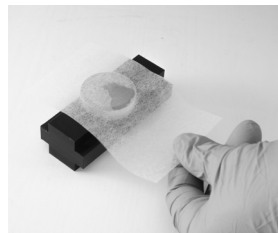

Step 3

Slowly pull the lens paper across the lens so the cleaning fluid comes in contact with the entire lens surface. Finish pulling the paper across so all of the fluid has dried from the lens.

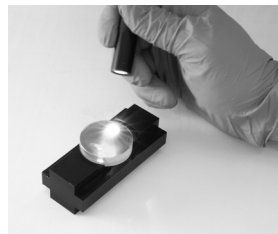

Step 4

Inspect the surface of the lens for dust and cleaning residue using a flashlight. Examine the lens from different angles. Repeat the process on the other side of the lens.

Final step:

Place the cleaned lens in the machine quickly to avoid contamination from airborne particles. If spots, pits, or scratches are still noticeable, the lens may need to be replaced.

Centricut is not affiliated with the named manufacturers. Reference to machines, parts, descriptions, and model numbers are for convenience in verifying compatibility only. All parts are made by or for Centricut and are not made by the referenced manufacturers (unless expressly indicated). Centricut is a registered trademark of Hypertherm, Inc. All other trademarks are the properties of their respective owners.

Polyester swabs

Recommended for cleaning curved lenses and where more aggressive cleaning is required. Interchangeable with polyester wipes.

You will need:

- Lens maintenance base (lens holder)
- Optical cleaning fluid
- Air bulb
- Polyester swabs
- Latex or rubber gloves

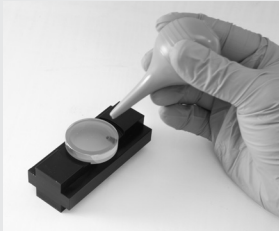

To get started

Using rubber gloves, place the lens in the lens holder and remove all loose contaminants with an air bulb. When contaminants are no longer visible, begin the cleaning process.

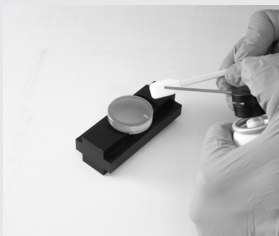

Step 1

Place a few drops of the optical cleaning fluid onto the swab.

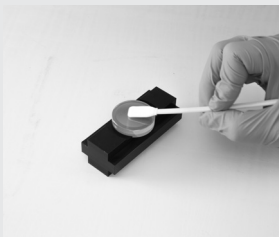

Step 2

Move the larger dirt particles and then finer contaminants to the edge of the lens using the swab. Do not rest the swab on the lens or on the work table. Do not reuse swabs.

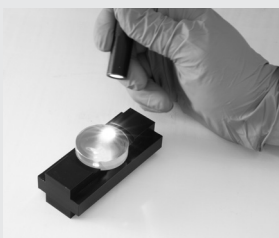

Step 3

Inspect the surface of the lens for dust and cleaning residue using a flashlight. Examine the lens from different angles. Repeat the process on the other side of the lens.

Final step:

Place the cleaned lens in the machine quickly to avoid contamination from airborne particles. If spots, pits, or scratches are still noticeable, the lens may need to be replaced.

Polyester wipes

Recommended for cleaning CO₂ and fiber lenses and windows. Interchangeable with polyester swabs and lens paper.

You will need:

- Lens maintenance base (lens holder)
- Optical cleaning fluid
- Air bulb
- Polyester wipes
- Latex or rubber gloves

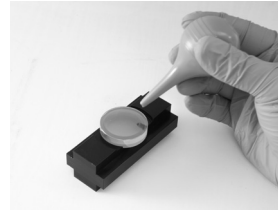

To get started

Using rubber gloves, place the lens in the lens holder and remove all loose contaminants with an air bulb. When contaminants are no longer visible, begin the cleaning process.

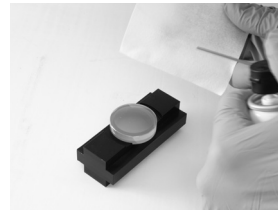

Step 1

Place a few drops of the optical cleaning fluid onto the polyester wipe



Step 2

Place the wipe with the wet side down on the lens and slide it across the lens, applying light pressure to the top of the wipe. Avoid contamination to the wipe and do not reuse wipes.

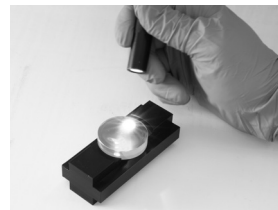

Step 3

Inspect the surface of the lens for dust and cleaning residue using a flashlight. Examine the lens from different angles. Repeat the process on the other side of the lens.

Final step:

Place the cleaned lens in the machine quickly to avoid contamination from airborne particles. If spots, pits, or scratches are still noticeable, the lens may need to be replaced.

Steps to help optimize cut quality.

Striation marks, angularity and dross tell the story.

Optimizing CO₂ and fiber lasers to achieve maximum cut quality is a very important step in the overall cutting process. The critical points that produce good cuts are the width of the kerf (the material that is lost during the cut), oxidation and roughness of the cut surface, the geometry of the cut parts and the allowable tolerances. Some factors to be considered are the cut speed or 'feed rate', beam focus, gas pressure, standoff and nozzle size/type.

Factory cut chart settings

The following samples show 12 mm, 6 mm and 3.2 mm (1/2", 1/4" and 10 ga.) mild steel, cut with O₂ on a 2 kW fiber laser with one variable changed to show how cut quality is affected. The adjustments will be similar for all CO₂ and fiber laser, cutting mild steel with O₂.

Is the kerf too narrow?

When the kerf is too narrow the cut will have a very smooth edge on the top, a lack of oxidation on the bottom and/or heavy dross.

Probable causes:

- Focus is too low
- Feed rate is too fast
- Gas pressure is too low
- Nozzle size is too small
- Standoff is too low

Follow these steps to optimize cut quality:

1. Use the closest known settings for the material being cut.
2. Use a test part that has both interior and exterior features.
3. Verify that the lens and/or window is clean and in good condition.
4. Verify that the nozzle is centered properly and is in good condition.
5. Adjust the focus up and down until the cut quality starts to get bad and then set to the middle of that range.
6. Adjust the gas pressure up and down until the cut starts to get bad and then set to the middle of that range.
7. Adjust the feed rate up by 5% increments. When the cut starts to get bad, set the feed rate 10% slower.

Strike a balance between heat levels and gas flow

Cutting mild steel with a laser is a balance of how much material is heated by the laser beam and how much assist gas flows through the cut.

- Heating up too small of an area, or not having enough assist gas flow through the cut will result with the kerf (width of the cut) being too narrow.
- Heating up too large of an area or having too much assist gas flow through the cut will result in the kerf being too wide.

Is the kerf too wide?

When the kerf is too wide the cut will have a rougher edge, more self burning in the corners of the part, more angularity on the cut edge and occasionally, dross.

Probable causes:

- Focus is too high
- Feed rate is too slow
- Gas pressure is too high
- Nozzle size is too big
- Standoff is too high
- Incorrect nozzle type

3.2 mm (10 ga.) mild steel cut resulting in too narrow kerf

Factory cut chart settings



Focus is too low

The kerf is too narrow and doesn't allow enough O₂ into the cut to remove all the molten material.

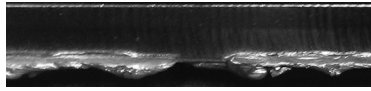

Feed rate is too fast

The cut striations are trailing the direction of cutting and there is not enough time to remove all the molten material.

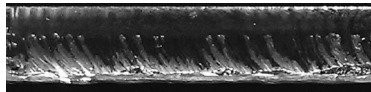

Gas pressure is too low

There is not enough O₂ to remove all the molten material.

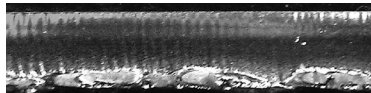

Stand off is too low

The focus spot is in the wrong location, causing the rough edge.

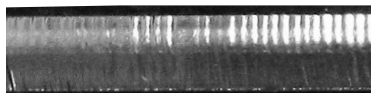

3.2 mm (10 ga.) mild steel cut resulting in too wide kerf

Factory cut chart settings

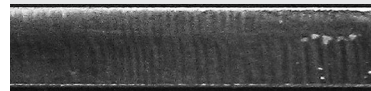

Focus is too high

The laser is melting more material than can be removed from the cut.

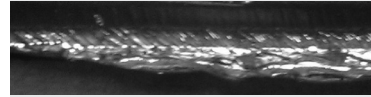

Feed rate is too slow

The cut surface is too rough and productivity is decreased.

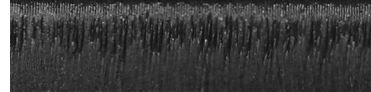

Gas pressure is too high

Too much O₂ results in overheating of the cut and causes intermittent gouges.

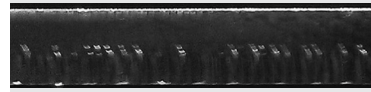

Stand off is too high

The laser is melting more material than can be removed from the cut.

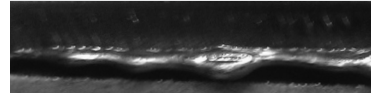

Nozzle size is too big

Too much O₂ results in overheating of the cut and causes intermittent gouges.



Cut direction

Cut direction

*Above samples have been cut with O₂ on 2 kW fiber laser. Results will be similar for CO₂ laser cutting mild steel with O₂.

**6 mm (1/4") mild steel cut
resulting in too narrow kerf**

Factory cut chart settings

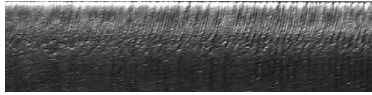

Focus is too low

The kerf is too narrow and doesn't allow enough O₂ into the cut to remove all the molten material.

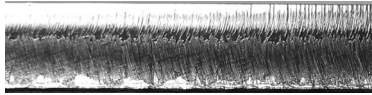

Feed rate is too fast

The cut striations are trailing the direction of cutting and there is not enough time to remove all the molten material.

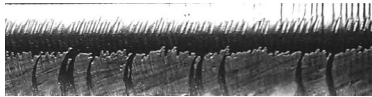

Gas pressure is too low

There is not enough O₂ to remove all the molten material.

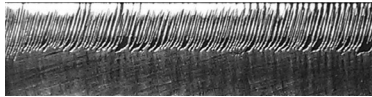

Stand off is too low

The focus spot is in the wrong location, causing the rough edge.

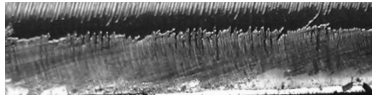

Nozzle size is too small

There is not enough O₂ to cut uniformly

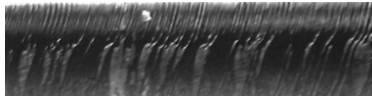

**6 mm (1/4") mild steel cut
resulting in too wide kerf**

Factory cut chart settings

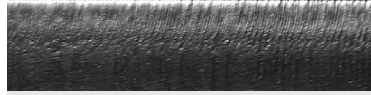

Focus is too high

The wider focus spot is letting too much O₂ into the cut and burning the material.

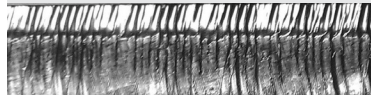

Feed rate is too slow

The cut surface is too rough and productivity is decreased.

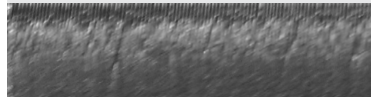

Gas pressure is too high

Too much O₂ is entering the cut, causing a rougher edge and inconsistent cutting.



Stand off is too high

Too much O₂ is entering the cut, causing a rougher edge and inconsistent cutting.

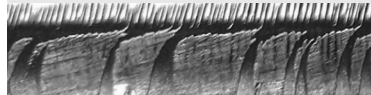

Nozzle size is too big

Too much O₂ results in overheating of the cut and causes intermittent gouges.



Nozzle type is incorrect

The shape of the gas flow is incorrect, causing a rougher edge.

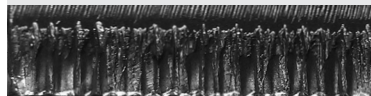

Cut direction

Cut direction

*Above samples have been cut with O₂ on 2 kW fiber laser. Results will be similar for CO₂ laser cutting mild steel with O₂.

Centricut is not affiliated with the named manufacturers. Reference to machines, parts, descriptions, and model numbers are for convenience in verifying compatibility only. All parts are made by or for Centricut and are not made by the referenced manufacturers (unless expressly indicated). Centricut is a registered trademark of Hypertherm, Inc. All other trademarks are the properties of their respective owners.

12 mm (1/2") mild steel cut resulting in too narrow kerf

Factory cut chart settings

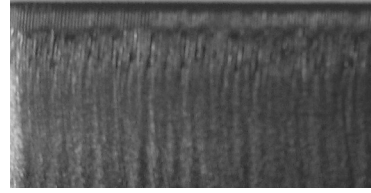
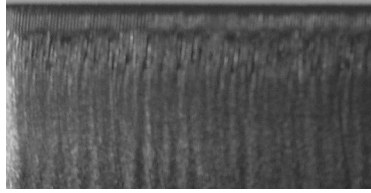

Factory cut chart settings

Focus is too low

The kerf is too narrow and doesn't allow enough O₂ into the cut to remove all the molten material.

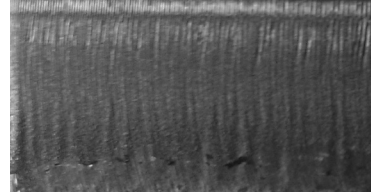
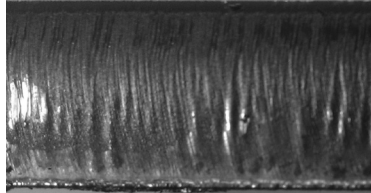

Stand off is too low

The kerf is too narrow to allow enough O₂ into the cut. The oxidation is not covering the entire surface and cutting will be inconsistent.

Feed rate is too fast

The machine is moving too fast to allow enough O₂ into the cut for consistent cutting.

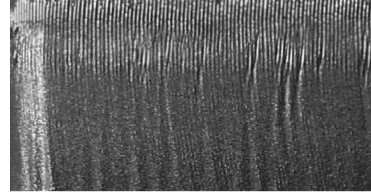
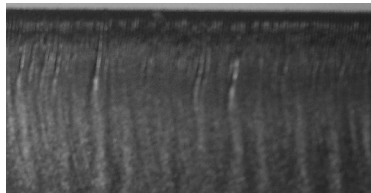

Nozzle size is too small

There is not enough O₂ to cut uniformly

Gas pressure is too low

The pressure is too low to allow enough O₂ into the cut. The oxidation is not covering the entire surface and cutting will be inconsistent.

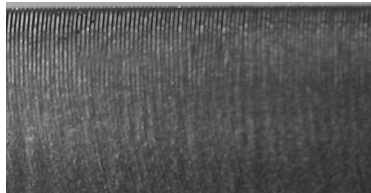

Cut direction

Cut direction

*Above samples have been cut with O₂ on 2 kW fiber laser. Results will be similar for CO₂ laser cutting mild steel with O₂.

Centricut is not affiliated with the named manufacturers. Reference to machines, parts, descriptions, and model numbers are for convenience in verifying compatibility only. All parts are made by or for Centricut and are not made by the referenced manufacturers (unless expressly indicated). Centricut is a registered trademark of Hypertherm, Inc. All other trademarks are the properties of their respective owners.

12 mm (1/2") mild steel cut resulting in too wide kerf

Factory cut chart settings

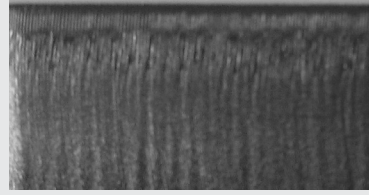
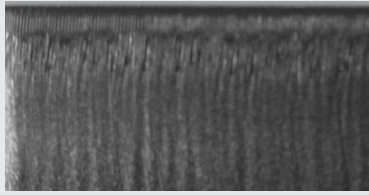

Factory cut chart settings

Focus is too high

Too much O₂ is entering the cut causing intermittent over burning.

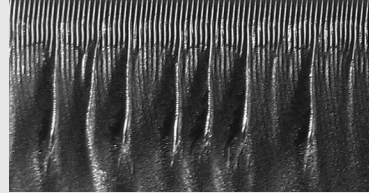
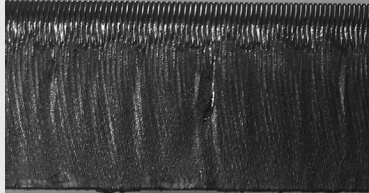

Stand off is too high

Too much O₂ is entering the cut resulting in intermittent over burning.

Feed rate is too slow

The machine is moving too slow resulting in the over burning of the bottom half of the cut. The slower feed rate also reduces productivity.

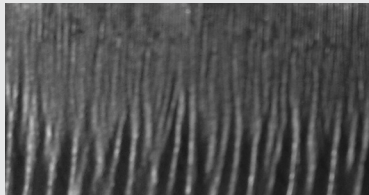

Incorrect nozzle type

The gas flow shape is not correct resulting in inconsistent cutting.

Gas pressure is too high

Too much O₂ is entering the cut resulting in intermittent over burning.

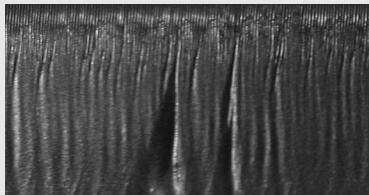

*Above samples have been cut with O₂ on 2 kW fiber laser. Results will be similar for CO₂ laser cutting mild steel with O₂.

Centricut is not affiliated with the named manufacturers. Reference to machines, parts, descriptions, and model numbers are for convenience in verifying compatibility only. All parts are made by or for Centricut and are not made by the referenced manufacturers (unless expressly indicated). Centricut is a registered trademark of Hypertherm, Inc. All other trademarks are the properties of their respective owners.

Technical support and customer service

Our technical service team can answer questions about any laser cutting system. Whether it's a question about a part, a system or for guidance on how to optimize laser cutting performance, our experts can help.

- OEM trained technicians with over 40 years experience
- Free application support for all laser OEMs
- We stand behind our products with industry-leading technical expertise



Contact a laser expert at ctlaser@hypertherm.com

HELPING YOU SHAPE THE WORLD.



PLASMA | LASER | WATERJET | AUTOMATION | SOFTWARE | CONSUMABLES

For more information on Centricut laser products,
visit www.hypertherm.com/laserconsumables
or email ctlaser@hypertherm.com

Hypertherm, Centricut, SilverLine and CoolFlow are trademarks of Hypertherm, Inc., and may be registered in the United States and/or other countries. All other trademarks are the property of their respective owners.

Environmental stewardship is one of Hypertherm's core values, and it is critical to our success and our customers' success. We are striving to reduce the environmental impact of everything we do. For more information: www.hypertherm.com/environment.



© 1/2019 Hypertherm, Inc. Revision 8
880480

Hypertherm®

SHAPING POSSIBILITY®

