



" - 1 new"
2070 2802 534



Схема наклейки
двухстороннего
скотча и профиля
МДФ на дверь

поз.20 Дверь в сборе - 1шт.
КН.НМ1.06.216.00.07.00



Шкаф для одежды 06.216
(собирается на правую
и левую стороны)

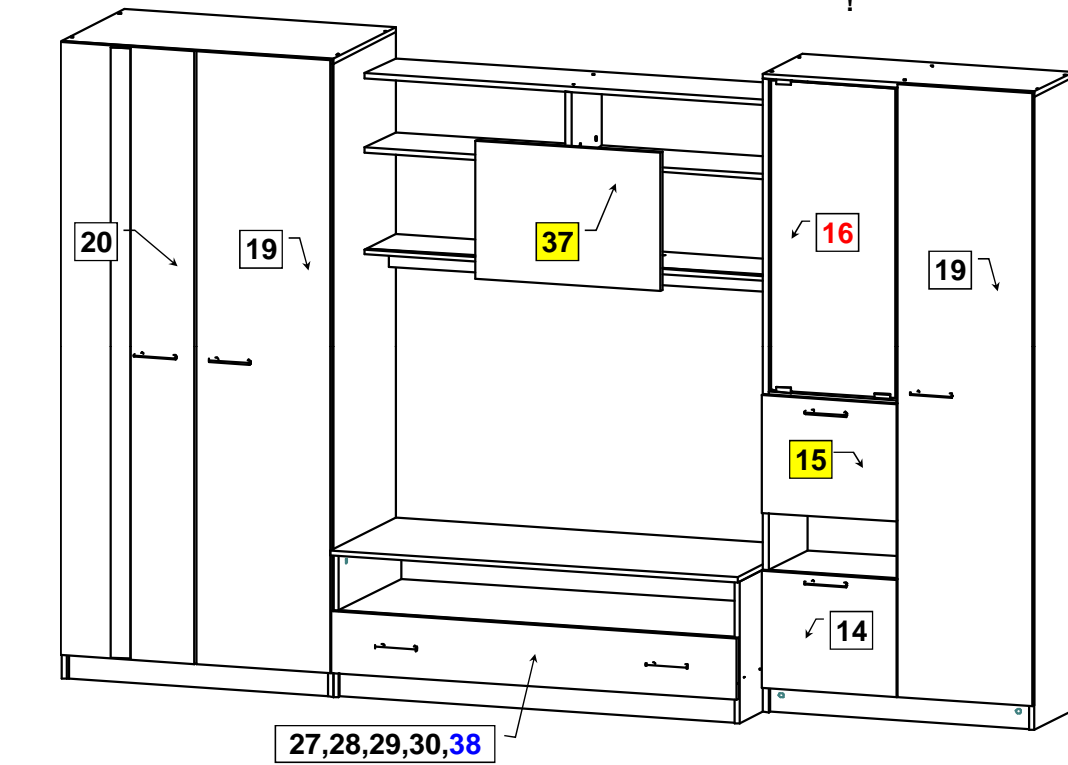
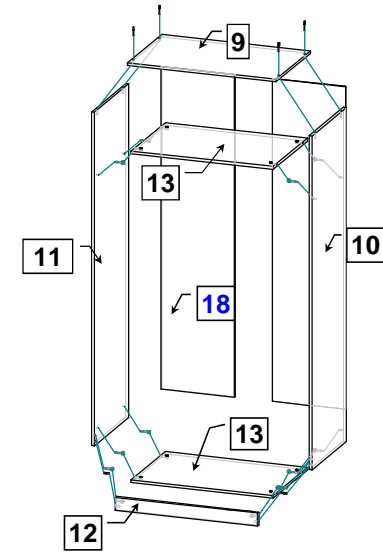
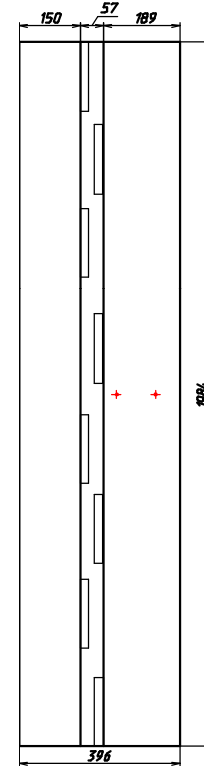
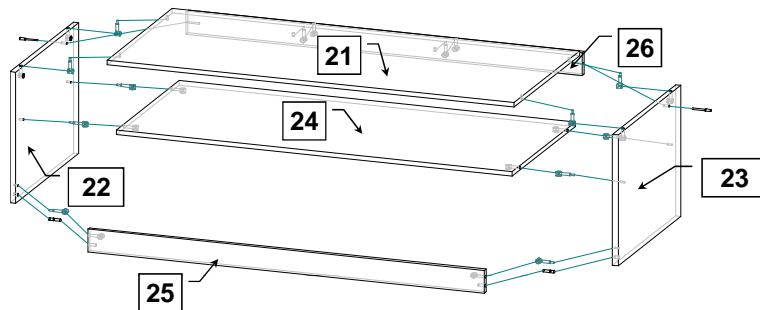

Тумба 06.217

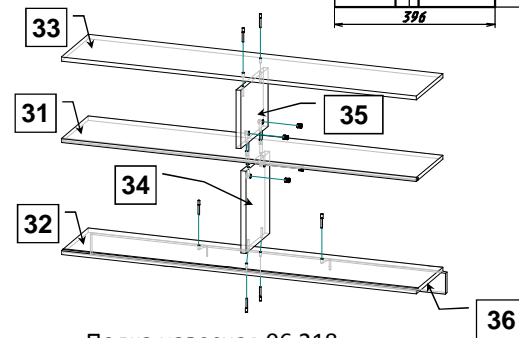

Полка навесная 06.218

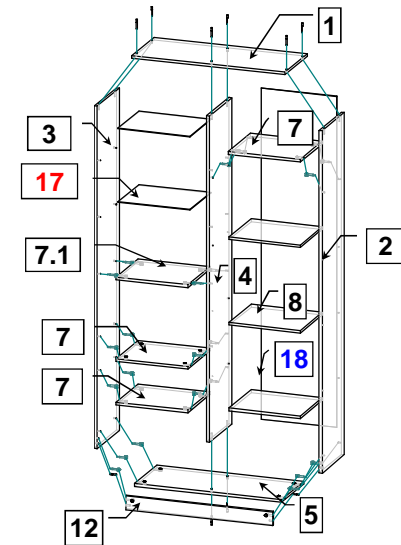

Шкаф комбинированный 06.219
(собирается на правую
и левую стороны)

1	.06.219.00.03.00-01		802 x 320	1	16,0	1/5
2	.06.219.00.01.00		2050 x 320	1	16,0	1/5
3	.06.219.00.02.00		2050 x 320	1	16,0	1/5
4	.06.219.00.05.00		1954 x 320	1	16,0	1/5
5	.06.219.00.04.00		768 x 320	1	16,0	1/5
7	.06.219.00.12.00		376 x 320	3	16,0	1/5
7.1	.06.219.00.12.00-01		376 x 320	1	16,0	1/5
8	.06.219.00.07.00		372 x 316	3	16,0	1/5
9	.06.216.00.03.00		802 x 510	1	16,0	2/5
10	.06.216.00.01.00		2050 x 510	1	16,0	2/5
11	.06.216.00.02.00		2050 x 510	1	16,0	2/5
12	.06.216.00.05.00		768 x 80	2	16,0	2/5
13	.06.216.00.04.00		768 x 510	2	16,0	2/5
14	.06.219.00.08.00		380 x 396	1	16,0	2/5
15	.06.219.00.09.00		380 x 396	1	16,0	2/5
16	.06.219.00.10.00-01		1002 x 368	1	4	5/5
17	.06.219.00.11.00-01		372 x 292	2	4	5/5
18	.06.216.00.08.00		1980 x 397	4	4,0	2/5
19	.06.216.00.06.00		1984 x 396	2	16,0	3/5
20	.06.216.00.07.00		1984 x 396	1	16,0	3/5
20.1	.06.216.00.06.00		1984 396	1	16,0	3/5
20.2	.06.216.00.07.01		1983 57	1		3/5
21	.06.217.00.01.00		1200 x 530	1	16,0	4/5
22	.06.217.00.02.00		460 x 510	1	16,0	4/5
23	.06.217.00.03.00		460 x 510	1	16,0	4/5
24	.06.217.00.04.00		1166 x 510	1	16,0	4/5
25	.06.217.00.05.00		1166 x 80	1	16,0	4/5
26	.06.217.00.11.00		1166 x 80	1	16,0	4/5
27	.06.217.00.06.00		1196 x 200	1	16,0	4/5
28	.06.217.00.07.00		400 x 120	1	16,0	4/5
29	.06.217.00.08.00		400 x 120	1	16,0	4/5
30	.06.217.00.09.00		1110 x 120	1	16,0	4/5
31	.06.218.00.01.00		1200 x 250	1	16,0	4/5
32	.06.218.00.02.00		1200 x 250	1	16,0	4/5
33	.06.218.00.03.00		1200 x 250	1	16,0	4/5
34	.06.218.00.04.00		314 x 220	1	16,0	4/5
35	.06.218.00.005.00		224 x 250	1	16,0	4/5
36	.06.218.00.06.00		1200 x 80	1	16,0	4/5
37	.06.218.00.07.00		546 x 446	1	16,0	4/5
38	.06.217.00.12.00		1140 x 408	1	4,0	4/5

0621700

06.216. (! .)

.10, 11 .52 3 16 .58
 .46 4 16 .60. 8 .12 8 30
 .56. .10, 11 .40, 41
 .13, .12 .44 .9.
 .10, 11 .49 3,5 16 .59. .20.2
 .68 .20.1

06.219. (! .)

.2, 3 .52 3 16 .58
 .46, 47 4 16 .60. 8 .12 8 30
 .56. .2, 3 4 .40, 41
 .5,7 .12. .44 .1
 .2, 3, 4 .5 .4.

06.217.

.22, 23 .52
 3 16 .58 .50 3,5 16 .59.
 8 .25 8 30 .56. .26
 .40, 41 .21.
 .22, 23 .24 .21
 .26. .44

1. 7 50 .44
2. .40, 41
3. .28, 29
- 3 16 .58
4. 3,5 16 .59
- .28, 29 .50
- .38, .66.

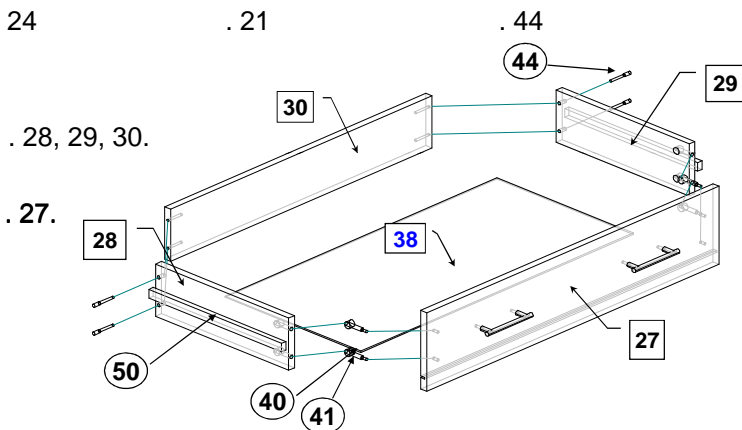





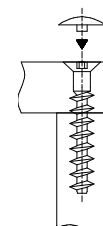
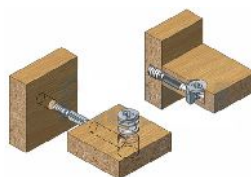





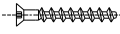





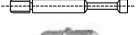

06.218.

.40, 53 .31
 .34, 35 .44 .32, 33
 .34, 35, 36. .31, 32 .63
 .37 (.64) 3,5 16 .59 .37.
 .31, 32, 33 .44 .3 10,
 3 16 .58 .18, Ø 7
 .65 (06.216). .14, 15, 19, 20. .62.
 5,0 .2, 3, 4 .54 .8
 .42, 43 .55 .17 (). .8 17.
 .1 (.67. .69, 47 .16
 .7.1 .16 Ø 8 .1)



7 * 50

	40	
	41	DU 232 . Ø 5 .
	42	
	43	
	44	7 50
	45	
	46	0
	47	
	48	L=763 .
	49	
	50	L=400 .
	51	
	52	
	53	
	54	
	55	
	56	8 30
	57	()
	58	3 * 16
	59	3,5 * 16
	60	4 * 16
	61	4 * 25 ()
	62	
	63	L=1200 .
	64	(2 + 2)
	65	L=1950
	66	
	67	
	68	
	69	

- 1.
- 1.1 +5 40 .
- 2.
- 2.1 ()
- 2.2
- 2.3
- 2.4

16371-2014 « .»

025/2012 " " , , ,

24

() .

025/2012, 16371-2014

()

10 .

:

, 27.

606 400

WEB- : www.olmeko.ru / 8(83144) 66-777

