

Детали и узлы лебедки ТН190.00.000

Узел электропривода
ТН190.01.000

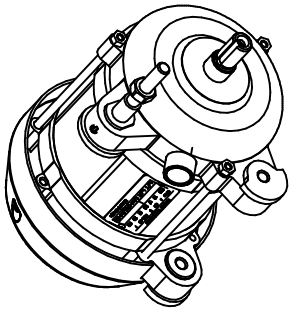

Барaban
ТН190.03.000

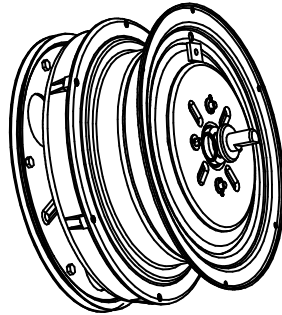

Фланец
ТН190.03.001

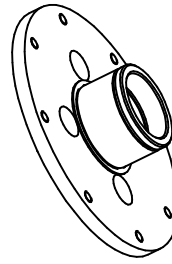

Крышка
ТН190.03.002
(Граднамид марки ПА6-ЛТ-СВ30,
ТУ РБ 500048054.020-2001)

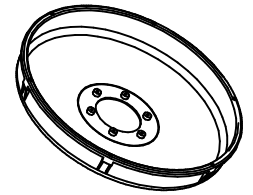

Кольцо
ТН190.03.003

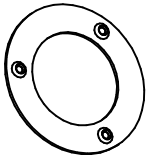

Пыльник
ТН190.03.004
(Войлок ПС4 ГОСТ 6308-71)

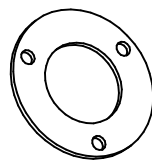

Втулка
ТН190.03.005

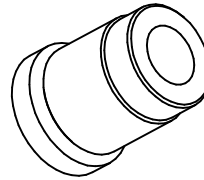

Шестерня
ТН190.03.006

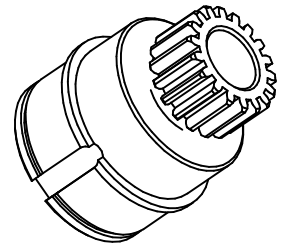

Корпус
ТН190.03.100

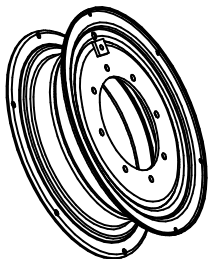

Отводка
ТН190.03.200

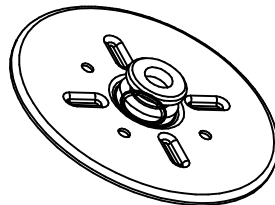

Шкив
ТН190.03.300

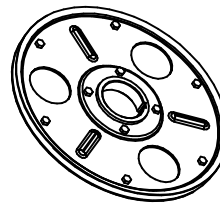

Опора
С52.30.00.00

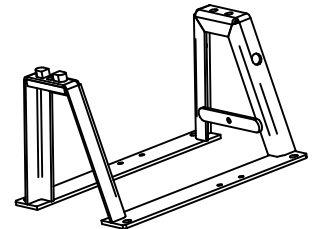

Пеdаль
С52.40.00.00

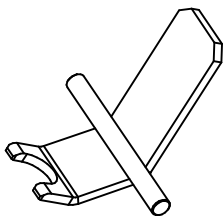

Кожух
С52.60.00.00

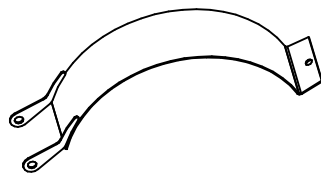

Якорь
С52.70.00.00

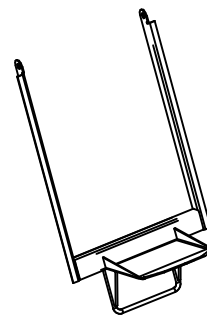

Крышка
С52.90.00.00

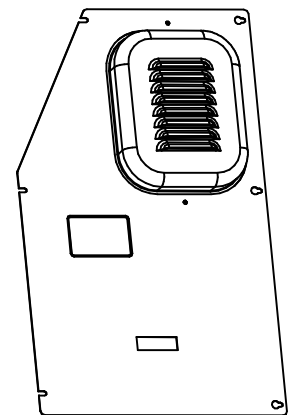

Шкив
С52.80.00.00

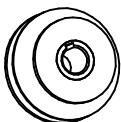

Колодка
С52.140.00.00

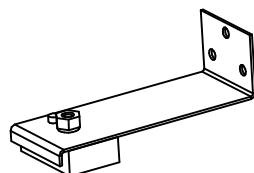

Ручка
С52.160.00.00
(Полиэтилен 276-84
ГОСТ 16338-85)

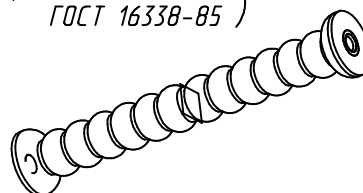

Вертулюг
С52.170.00.00

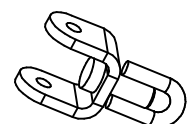

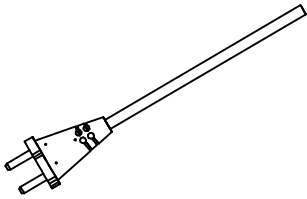
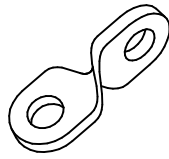
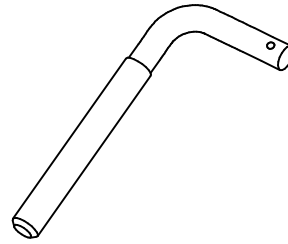
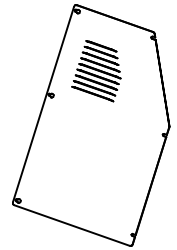
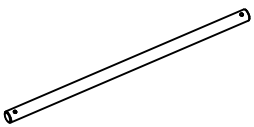
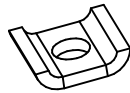
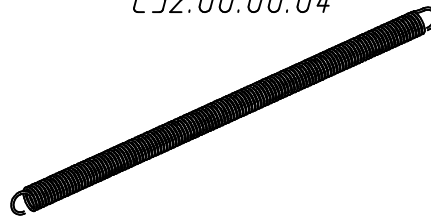
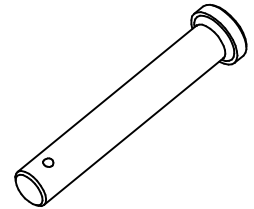
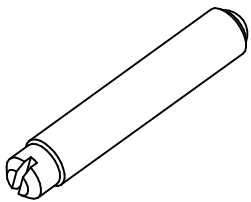
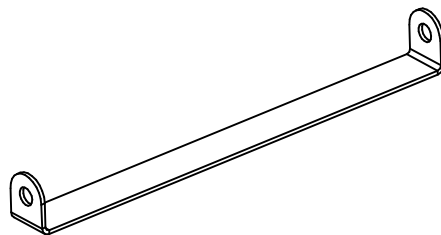
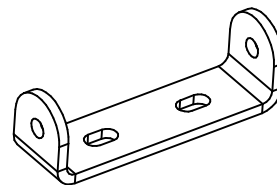
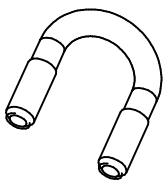
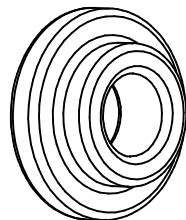
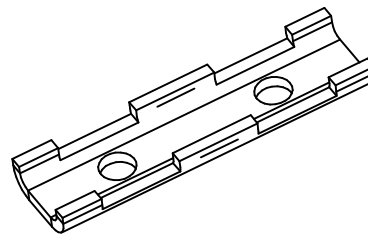
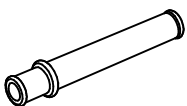
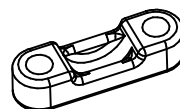
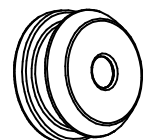
Детали и узлы лебедки ТН190.00.000Шнур армированный
ТН193.01.900Собачка
ТН190.00.002Болт специальный
ТН190.00.003Боковина
С52.00.00.01Ось
С52.00.00.02Прижим
С52.00.00.03Пружина
С52.00.00.04Палец
С52.00.00.24Винт
С52.00.00.25Скоба
С52.00.00.26Скоба
С52.00.00.27Скоба
С52.00.00.29Втулка
С52.00.00.31Прижим
С52.00.00.34Пластина
С52.00.00.35Трубка защитная
9063.07
(резина)Шайба
7869.01Хомутик
7291.02
(пластмасса)Втулка
С52.120.00.18
(резина)

Детали и узлы лебедки ТН190.00.000

Серьга
С52.20.00.03

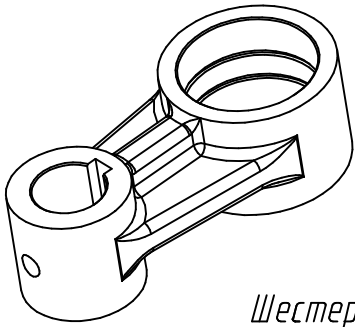

Колесо зубчатое
С52.20.00.05

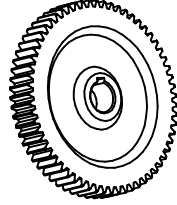

Шайба
С52.20.00.09



Болт установочный
С52.20.00.07



Шестерня
С52.20.00.02

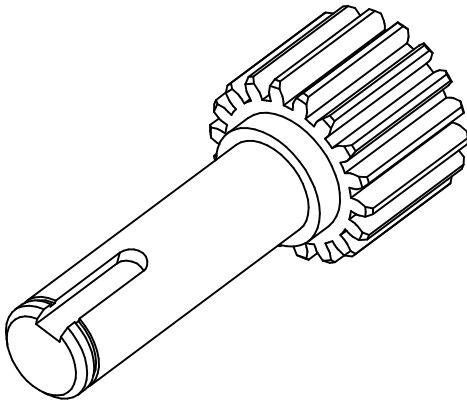

Втулка
С52.20.00.08

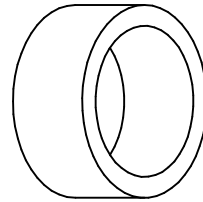

Втулка
С52.20.00.08-01

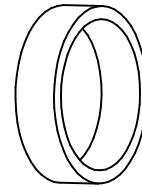

Палец
С52.20.00.12

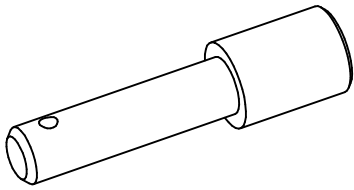

Вал
С52.20.00.01

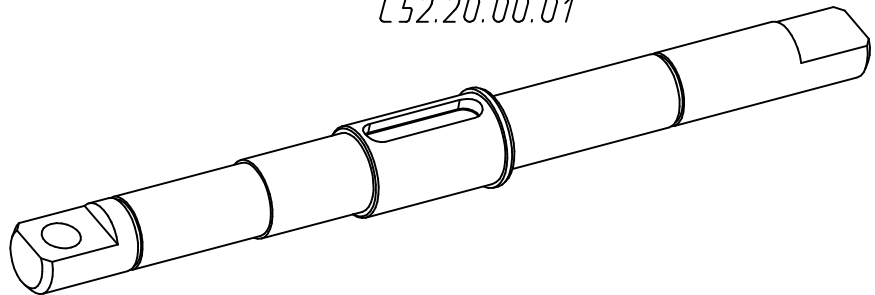

Колесо зубчатое
С52.20.00.06

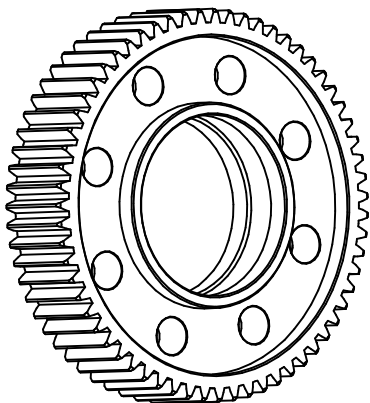

Пружина
С52.20.00.13

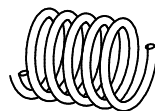

Детали и узлы лебедки ТН190.00.000,
которые изготавливались до 09.2013 г.

Пружина
 С52.00.00.05

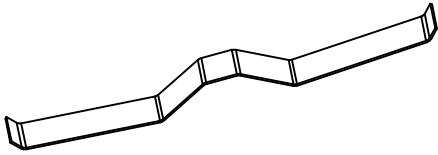

Коробка
 С52.00.00.11
 (пластмасса)

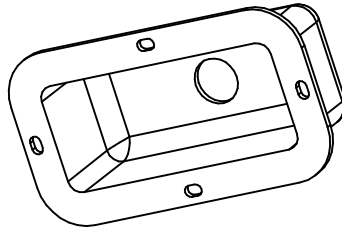

Прокладка
 С52.00.00.12
 (резина)

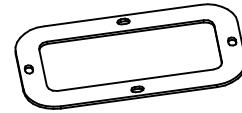

Корпус
 С52.10.00.00

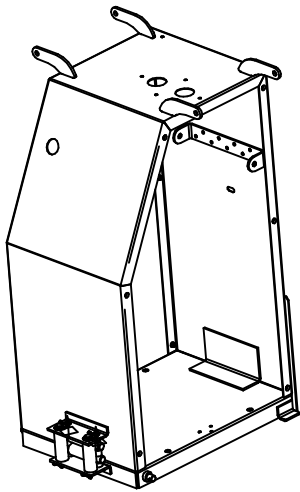

Коробка электрооборудования
 ТН190.02.000

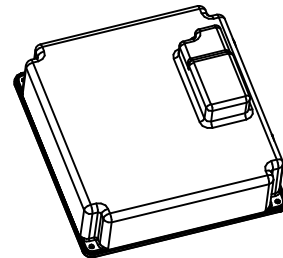

Детали и узлы лебедки ТН190.00.000,
которые изготавливались после 09.2013 г.

Кронштейн
 ТН190.00.004

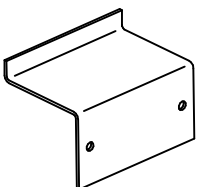

Корпус
 ТН190.08.000

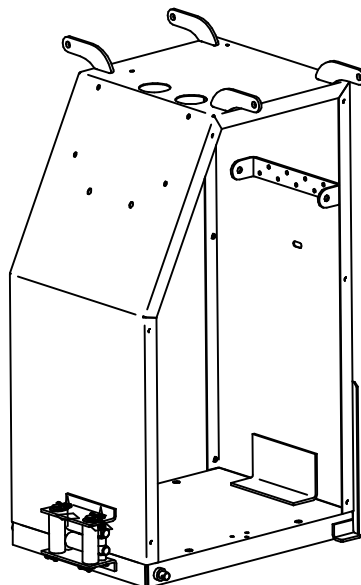

Коробка
 ТН190.09.000

