

ЛЕНА / LENA

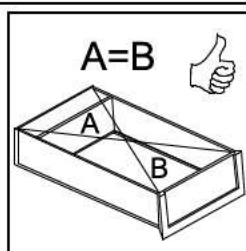

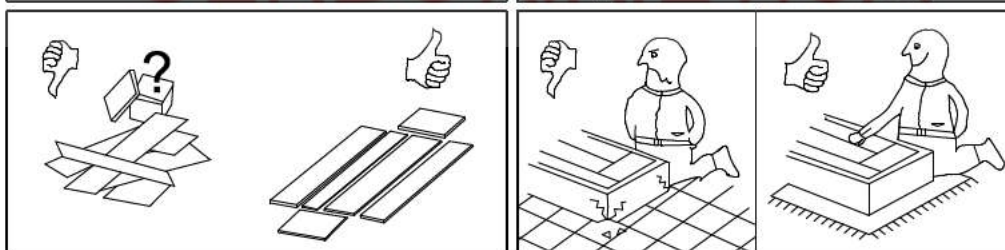

2x K16 a43	6x K0 a44	8x b19	3x L 340 mm c520	12x $\phi 5 \times 17$ mm d1	8x $\phi 5 \times 17$ mm d3
26x $\phi 7 \times 50$ mm e1	2x $\phi 6,3 \times 13$ mm e2	4x $\phi 5 \times 11$ mm e4	28x $\phi 8 \times 30$ mm f1	2x g2	9x 56x56,20 mm k52
110x l1	7x 3 mm l3	1x m48	2x n2	2x 50x12\1,5 mm n3	2x n10
1x 81x21x15\1,5mm n14	2x n122\1	4x silikon $\phi 8 \times 1,8$ mm o21	2x o43\1	1x o43\6	
4x $\phi 3,5 \times 13$ mm p1	6x $\phi 3,5 \times 13$ mm p5	9x $\phi 4 \times 30$ mm p9	22x $\phi 4 \times 30$ mm p21	16x $\phi 3,5 \times 15$ mm p51	7x $\phi 3 \times 16$ mm p52
4x $\phi 3 \times 10$ mm p400	14x $\phi 15 \times 12$ mm #16 r1	14x 20/9 r16	4x s1	12x $\phi 16$ s2	1x z1

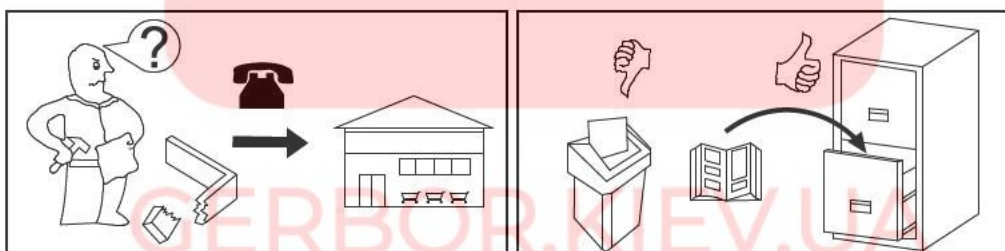
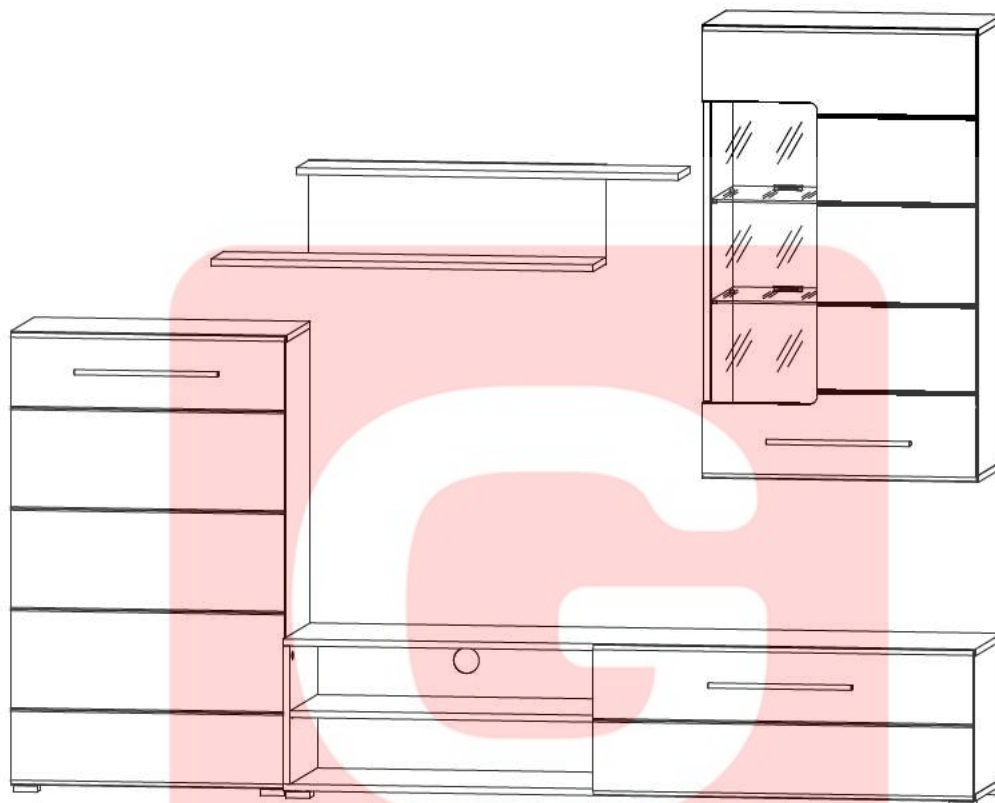
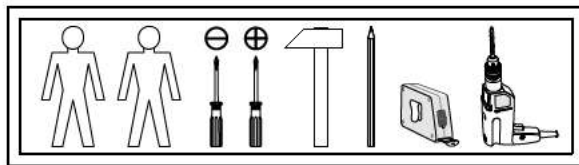
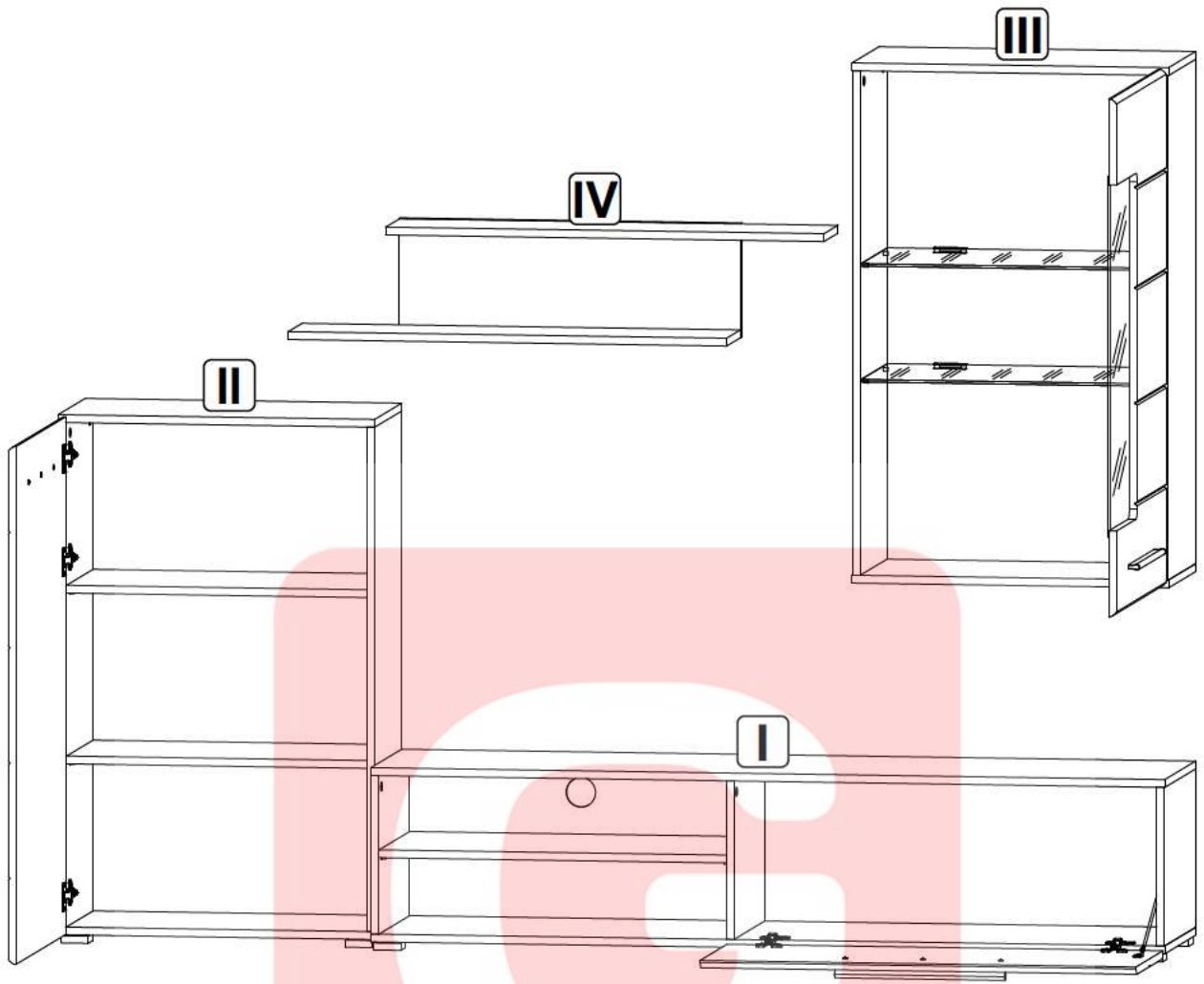
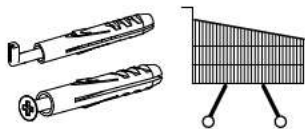

I Тумба PTB / Szafka RTV

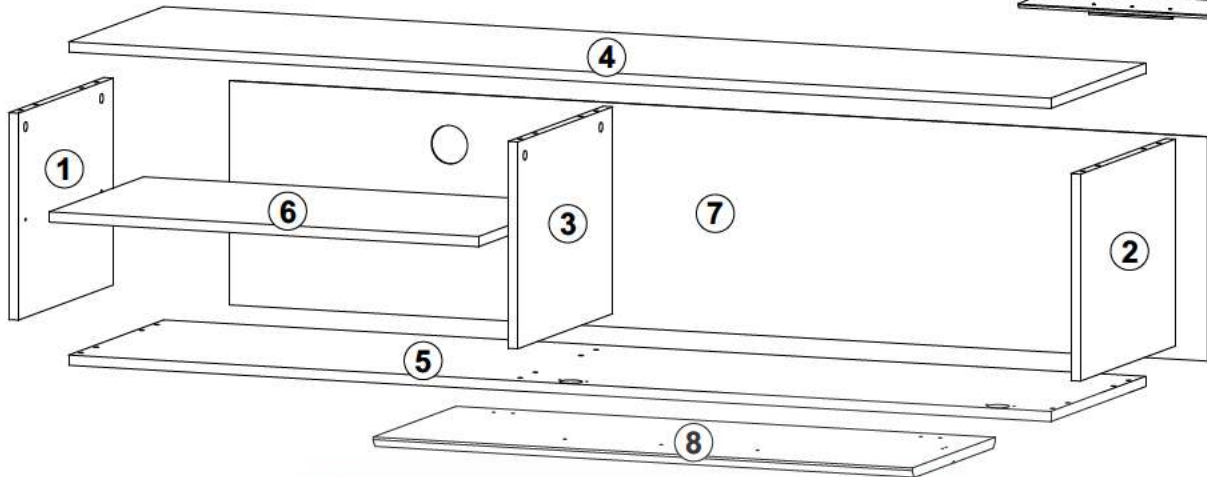
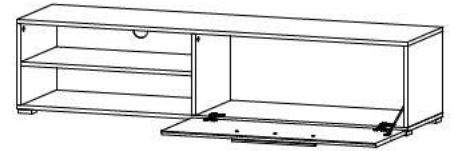

A	B	C	D	A	B	C	D		
1	ML1-105	323	400	1/3	5	ML1-205	1630	400	1/3
2	ML1-106	323	400	1/3	6	ML1-302	713	398	1/3
3	ML1-107	323	400	1/3	7	ML1-903	1624	350	1/3
4	ML1-204	1630	400	1/3	8	ML1-002-01	895	350	3/3



1 §2

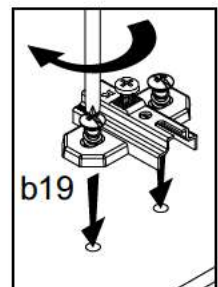
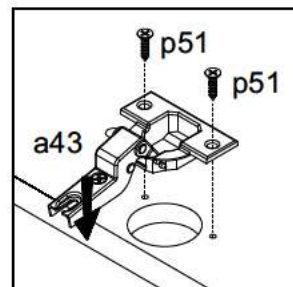
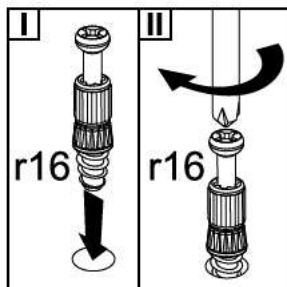
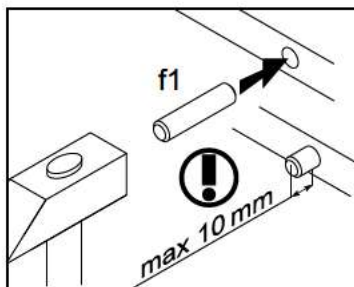
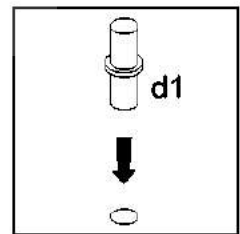
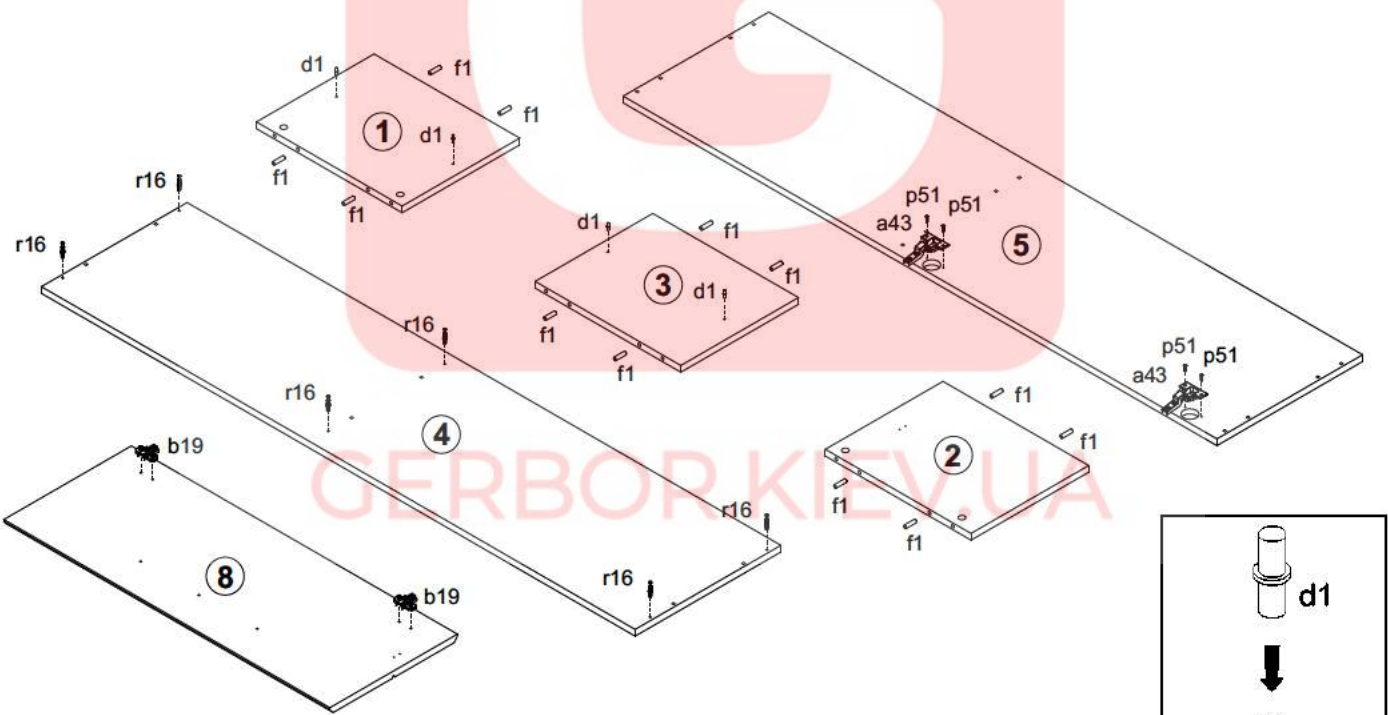
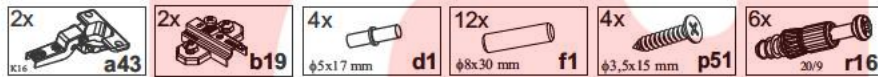

2

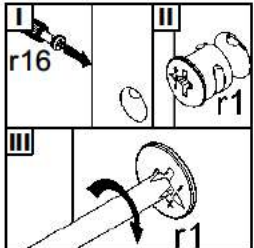
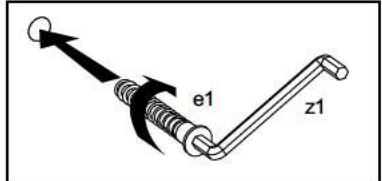
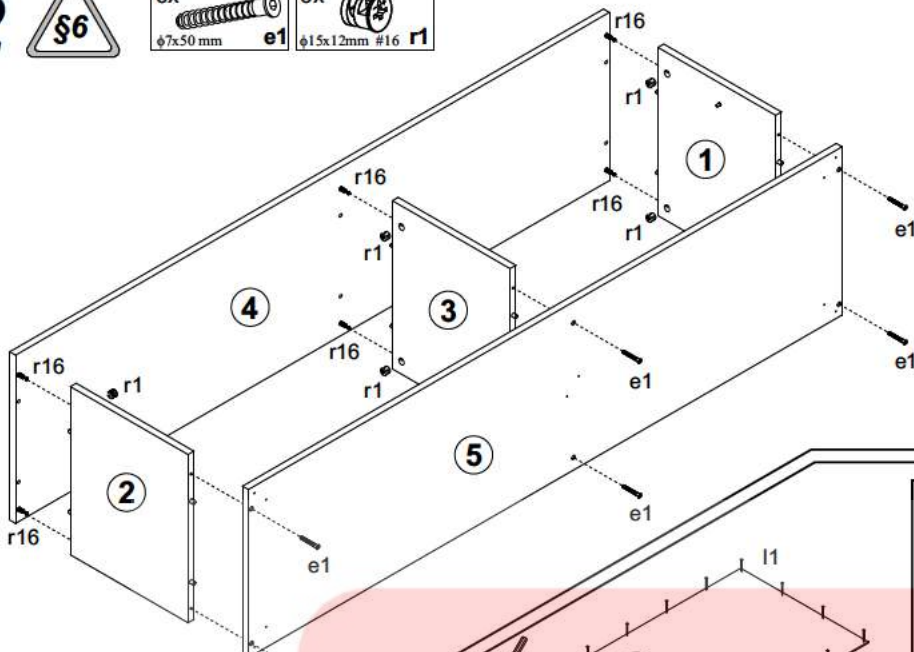
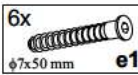

3

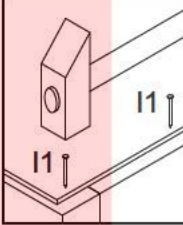
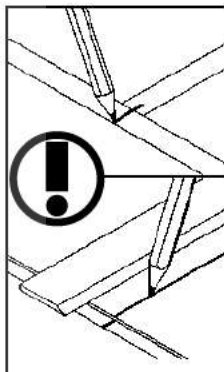
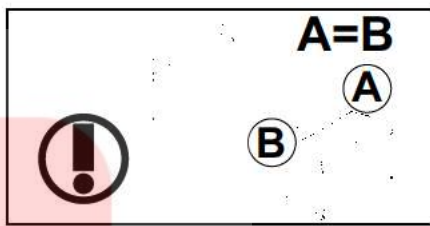
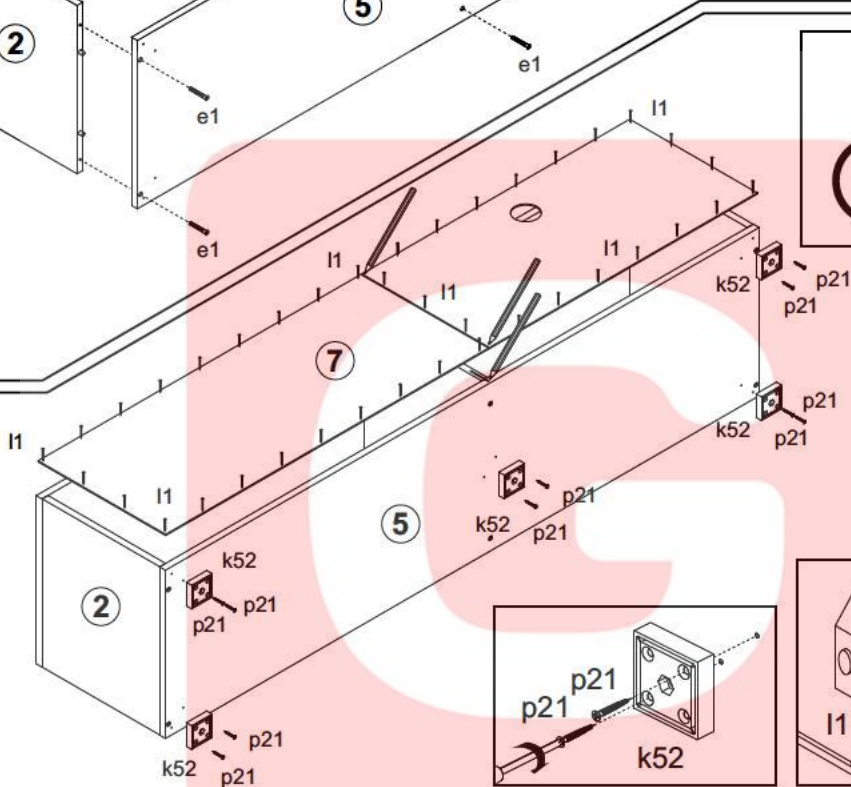
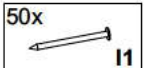

4

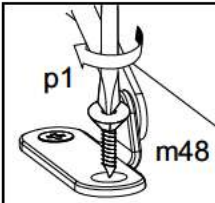
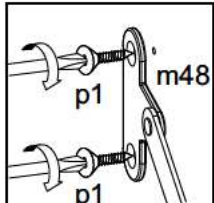
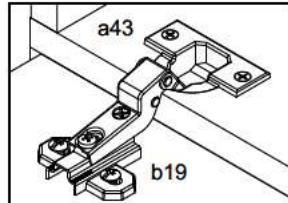
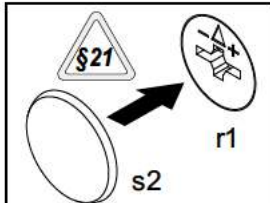
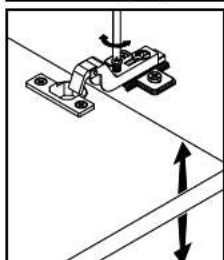
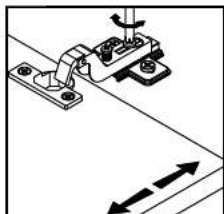
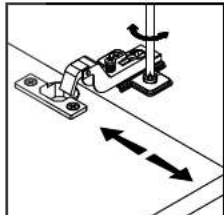
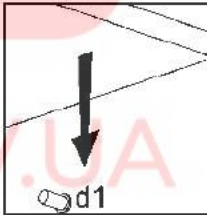
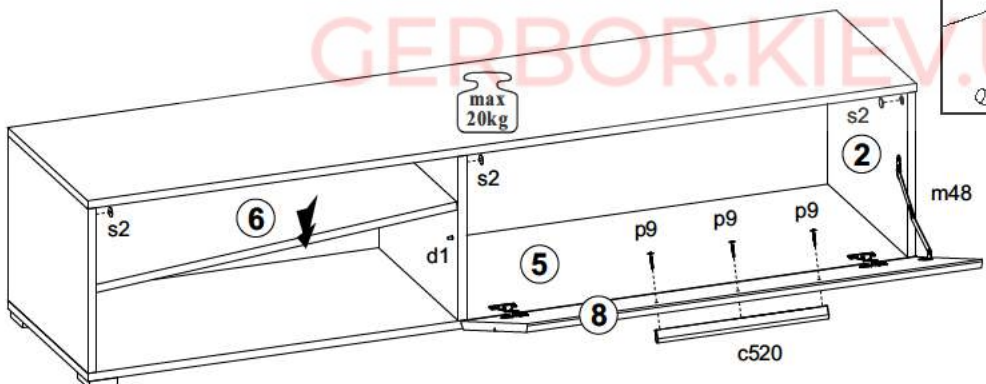

II Пенал / Regat

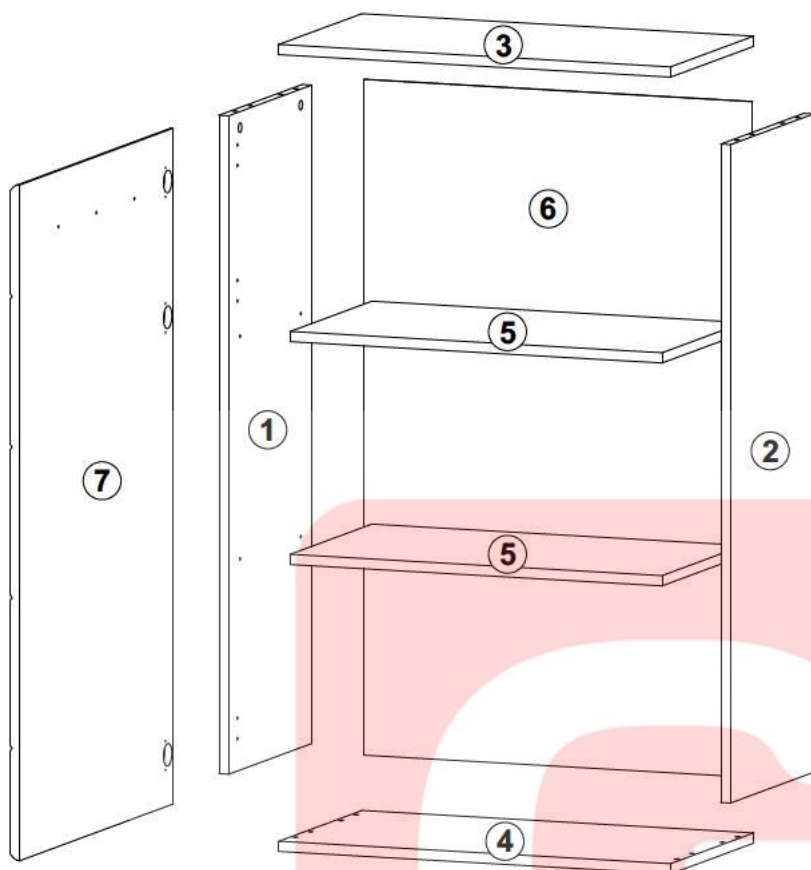
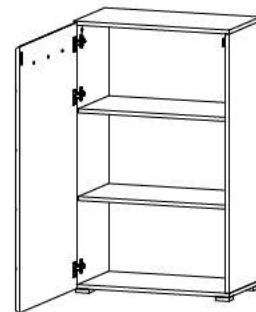

A	B	C	D
1	ML1-101	1028	350 2/3
2	ML1-102	1028	350 2/3
3	ML1-201	650	350 2/3
4	ML1-202	650	350 2/3
5	ML1-304	617	344 2/3
6	ML1-901	1055	644 3/3
7	ML1-001-01	645	1055 3/3

5 §2

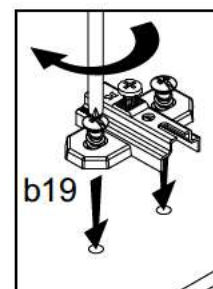
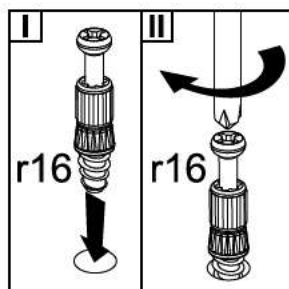
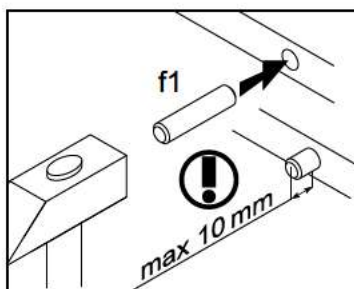
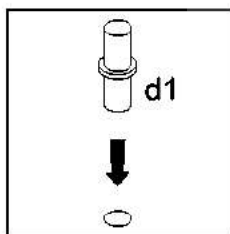
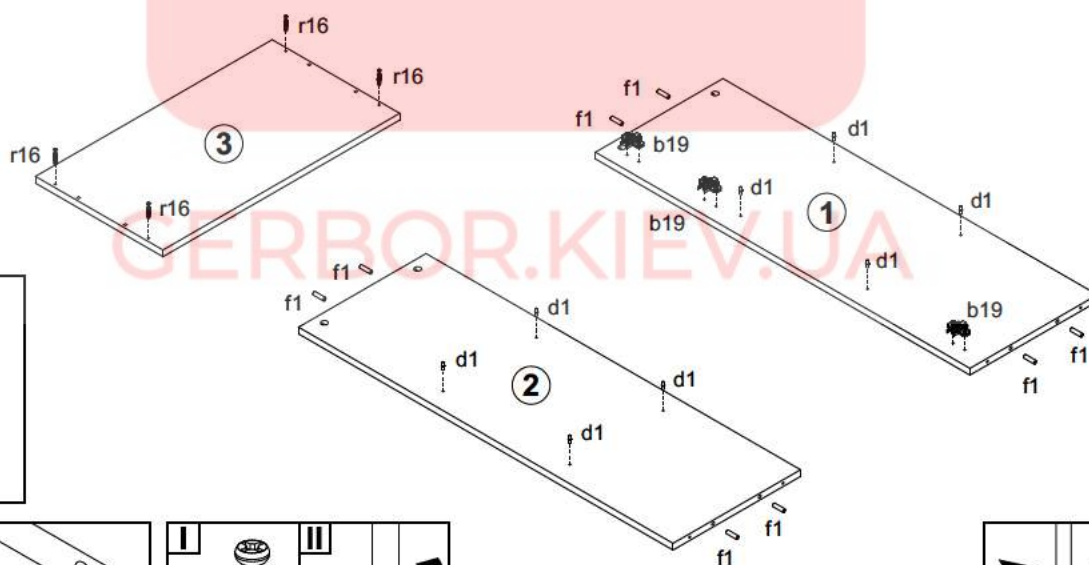
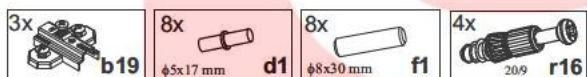

6

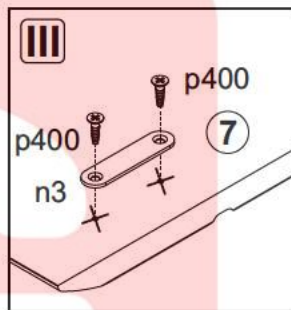
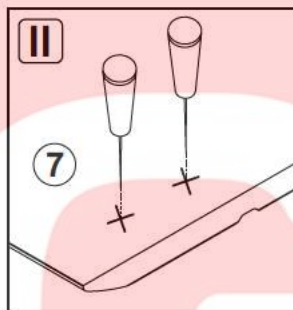
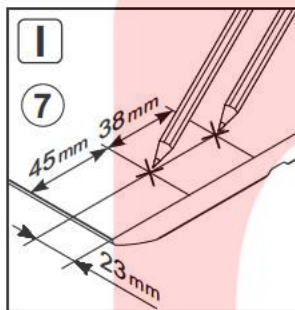
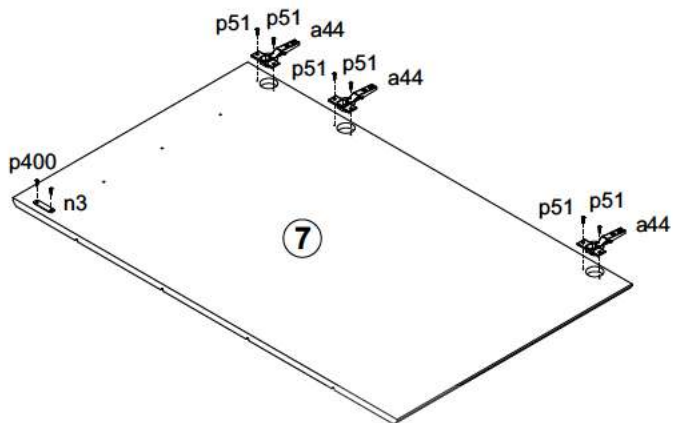
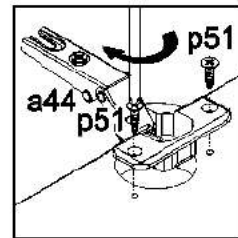

7

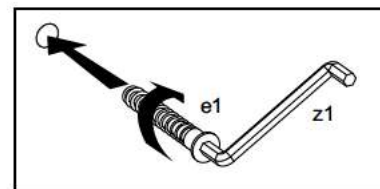
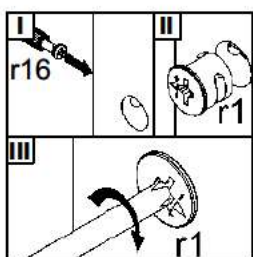
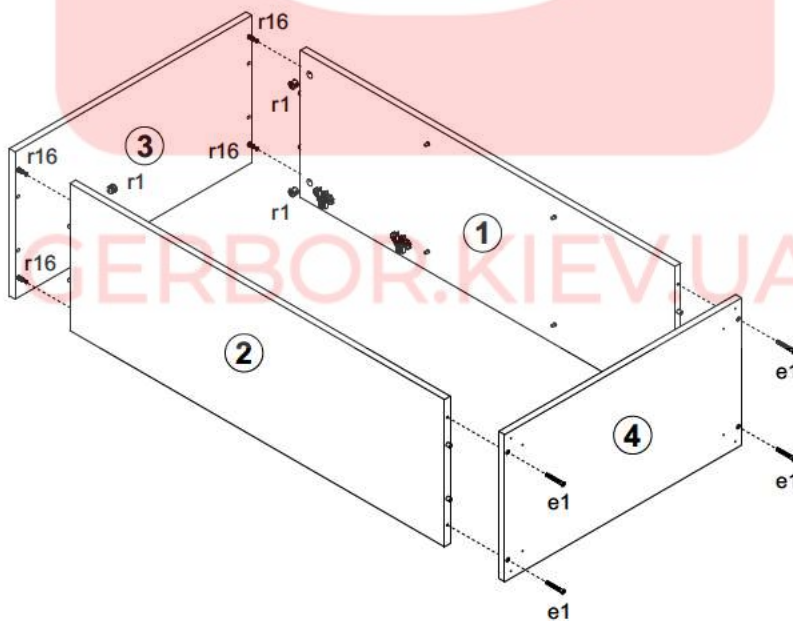

8

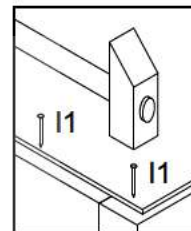
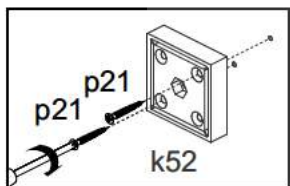
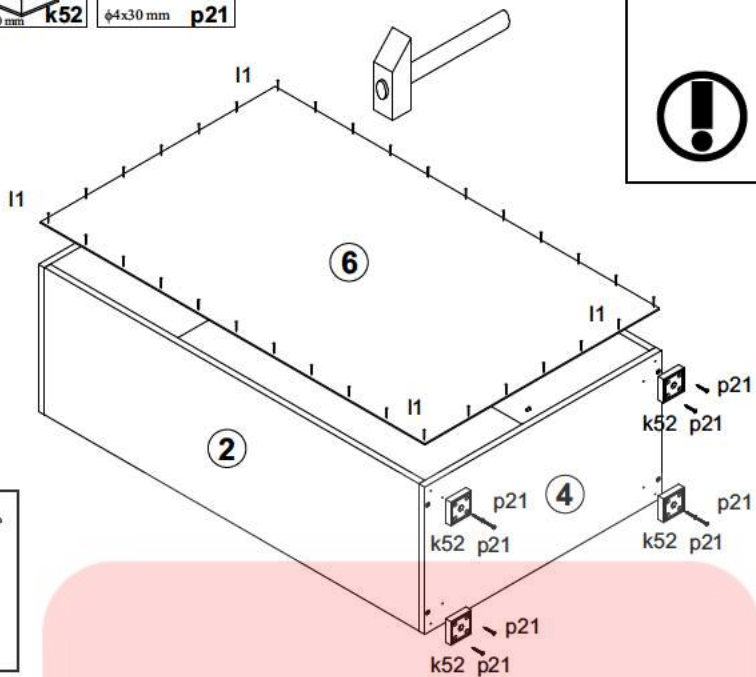
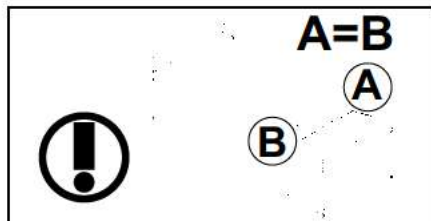

9

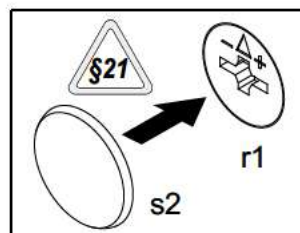
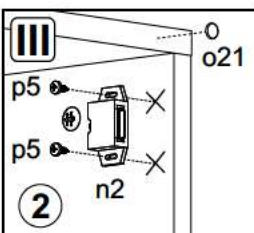
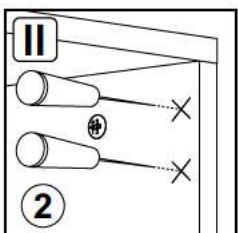
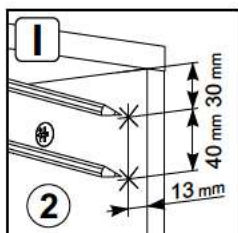
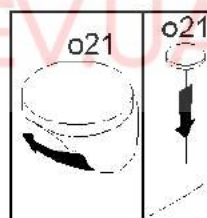
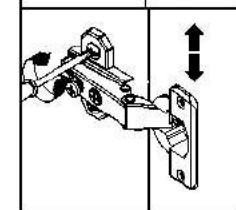
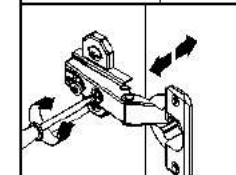
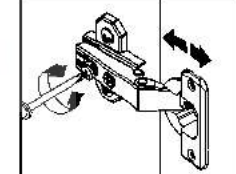
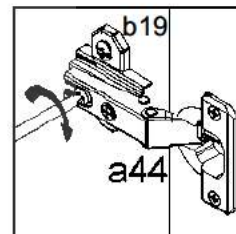
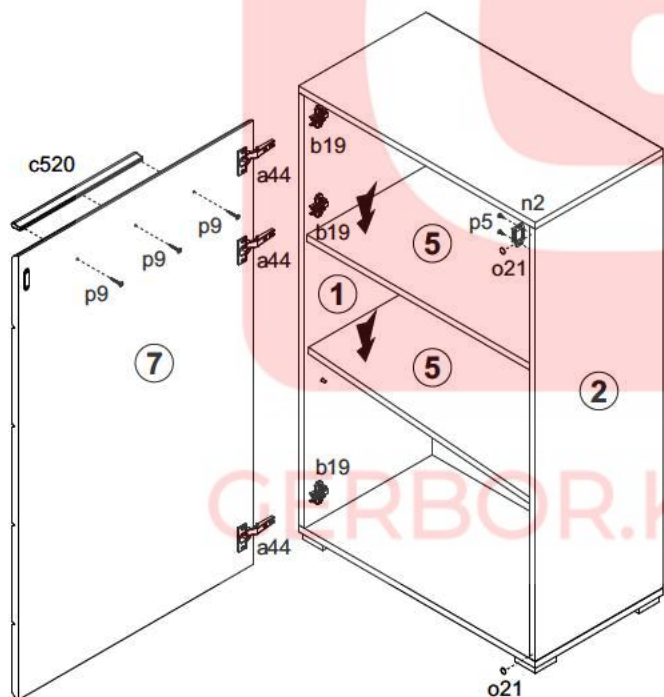
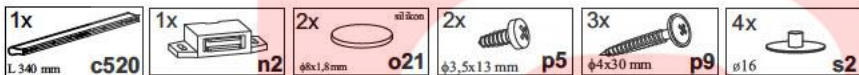



Вітрина навісна права / Витрина навесная правая / Witryna wisząca prawa

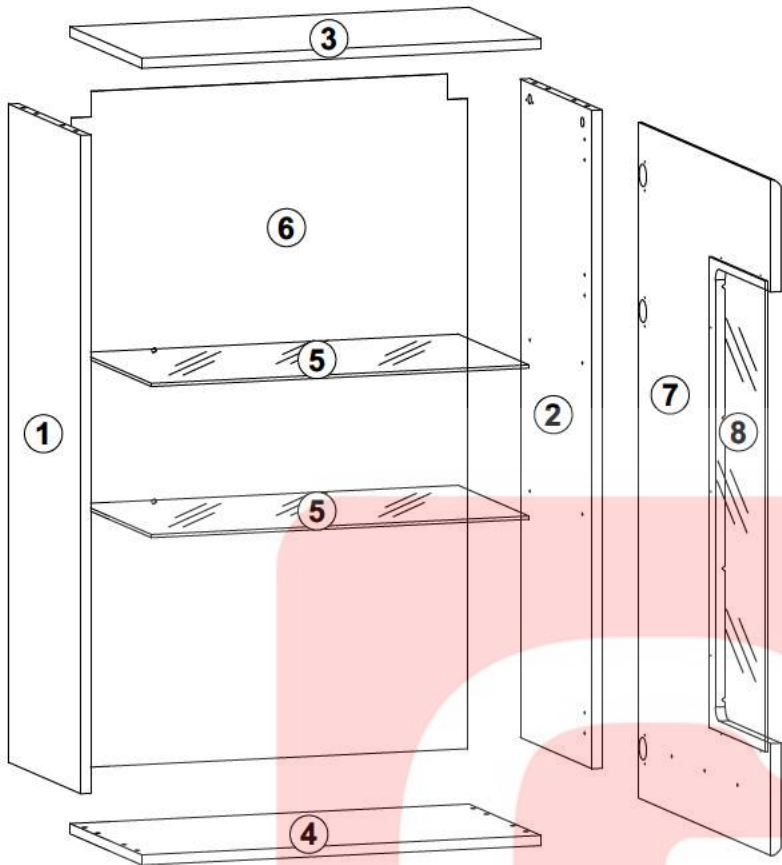





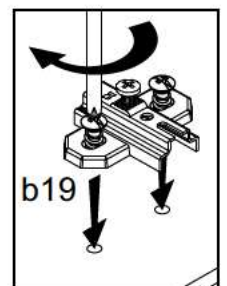
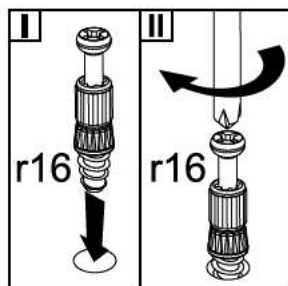
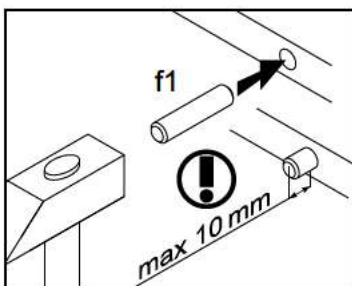
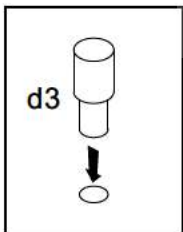
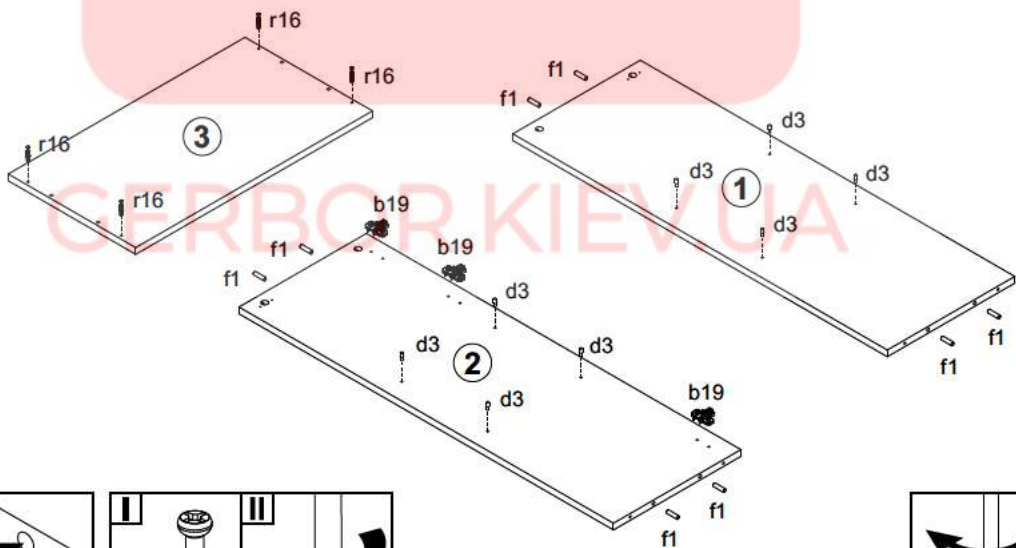
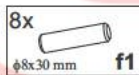

A	B	C	D	
1	ML1-103	1028	350	2/3
2	ML1-104	1028	350	2/3
3	ML1-201	650	350	2/3
4	ML1-203	650	350	2/3
5	ML1-301	615	329	2/3
6	ML1-902	1055	644	3/3
7	ML1-003-01	645	1055	3/3
8	ML1-501	735	270	3/3

10

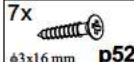

11

- 3x  a44
- 7x  l3
- 1x  n3
- 6x  p51
- 7x  p52
- 2x  p400

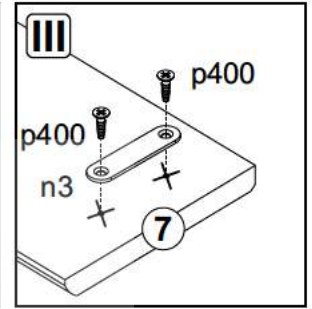
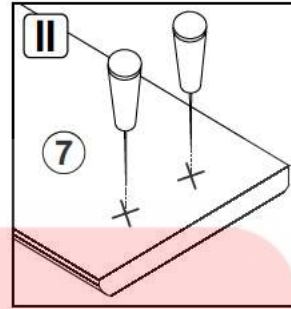
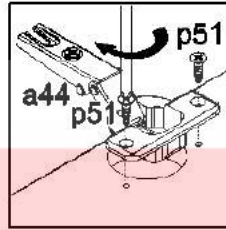
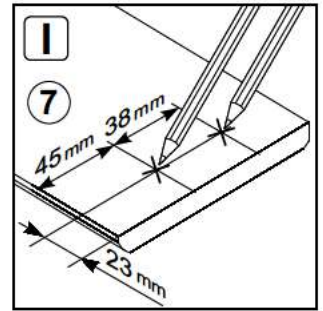
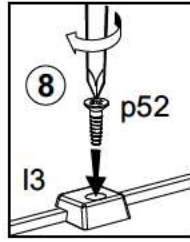
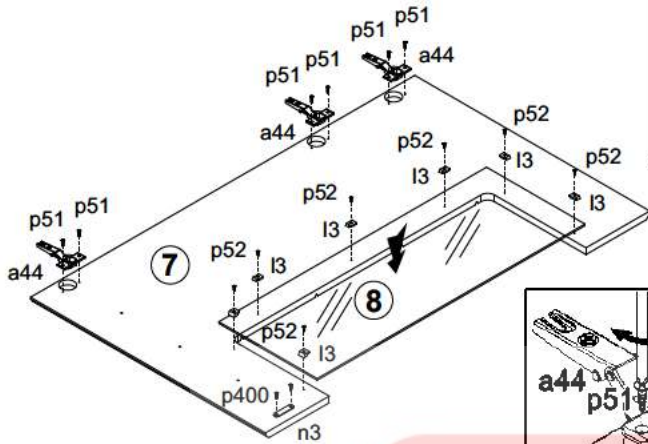

12

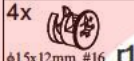

- 4x  e1
- 4x  z1

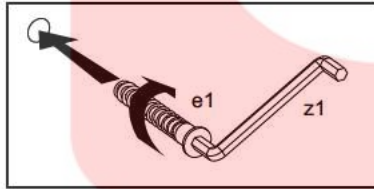
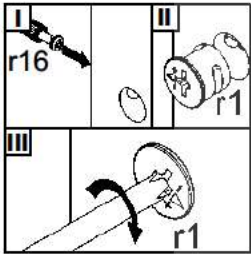
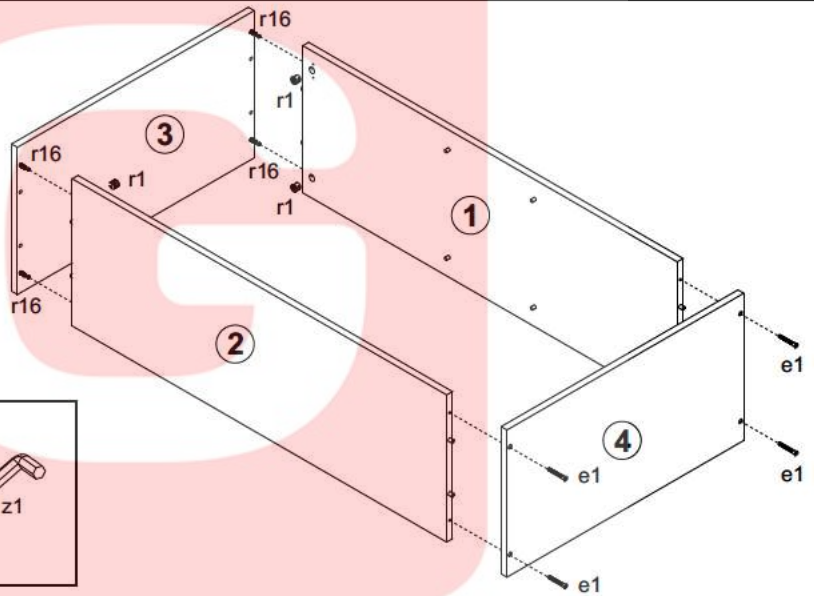

13

- 30x  l1

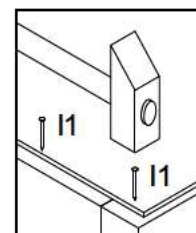
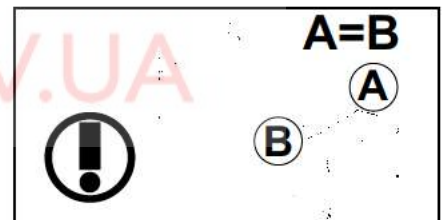
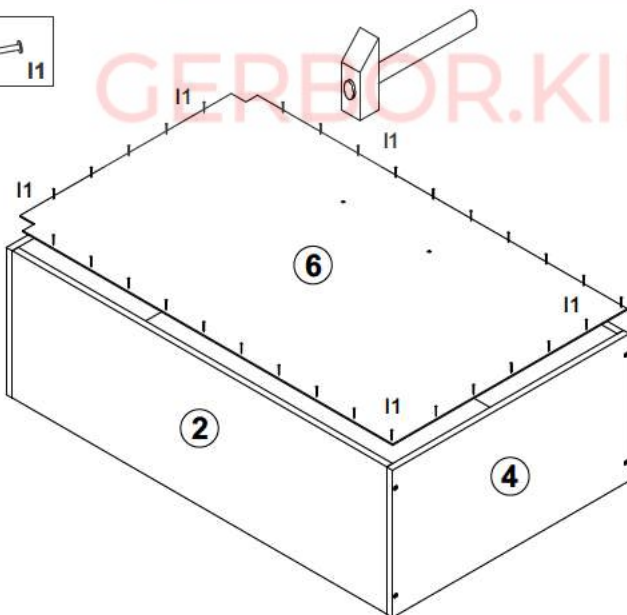

14

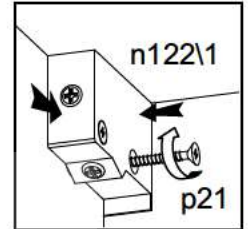
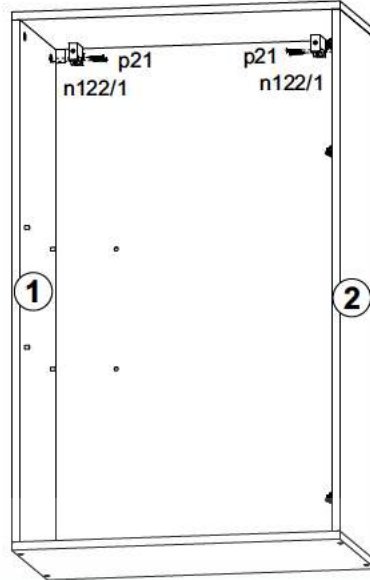
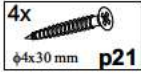
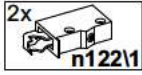

15

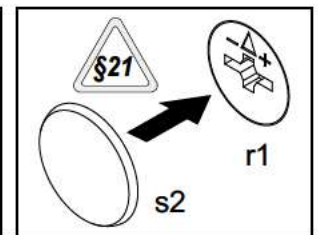
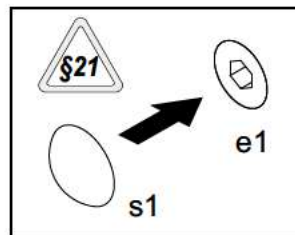
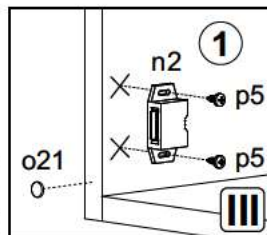
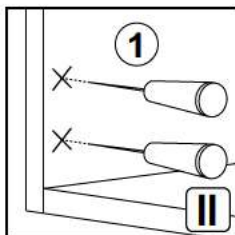
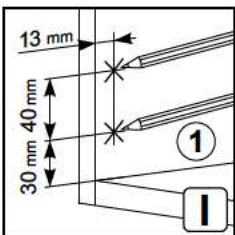
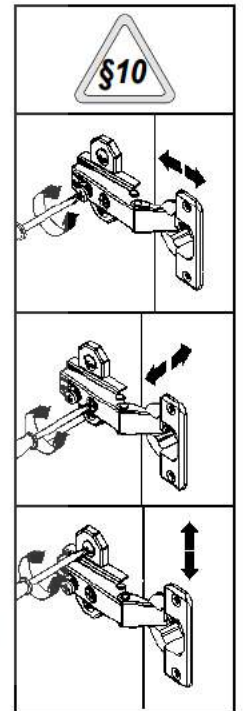
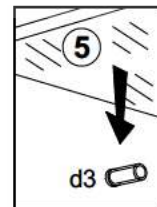
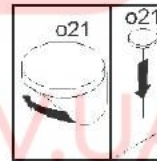
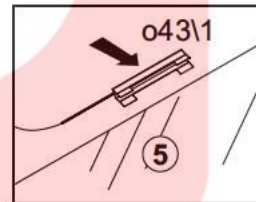
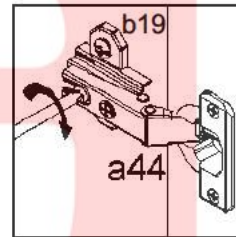
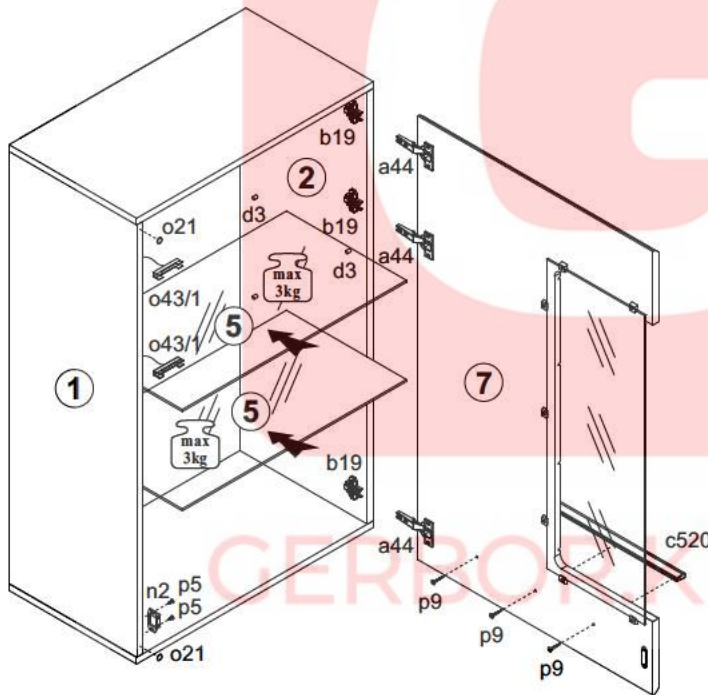
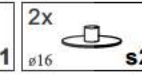
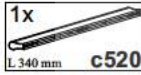

IV Полиця / Полка / Półka

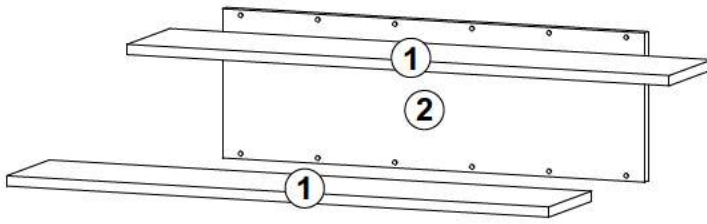
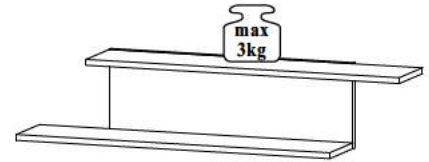

A	B	C	D
1	ML1-303	900	180
2	ML1-401	700	233

16

- 12x $\phi 7 \times 50$ mm e1
- 2x $\phi 6,3 \times 13$ mm e2
- 4x $\phi 5 \times 11$ mm e4
- 2x g2
- 1x z1

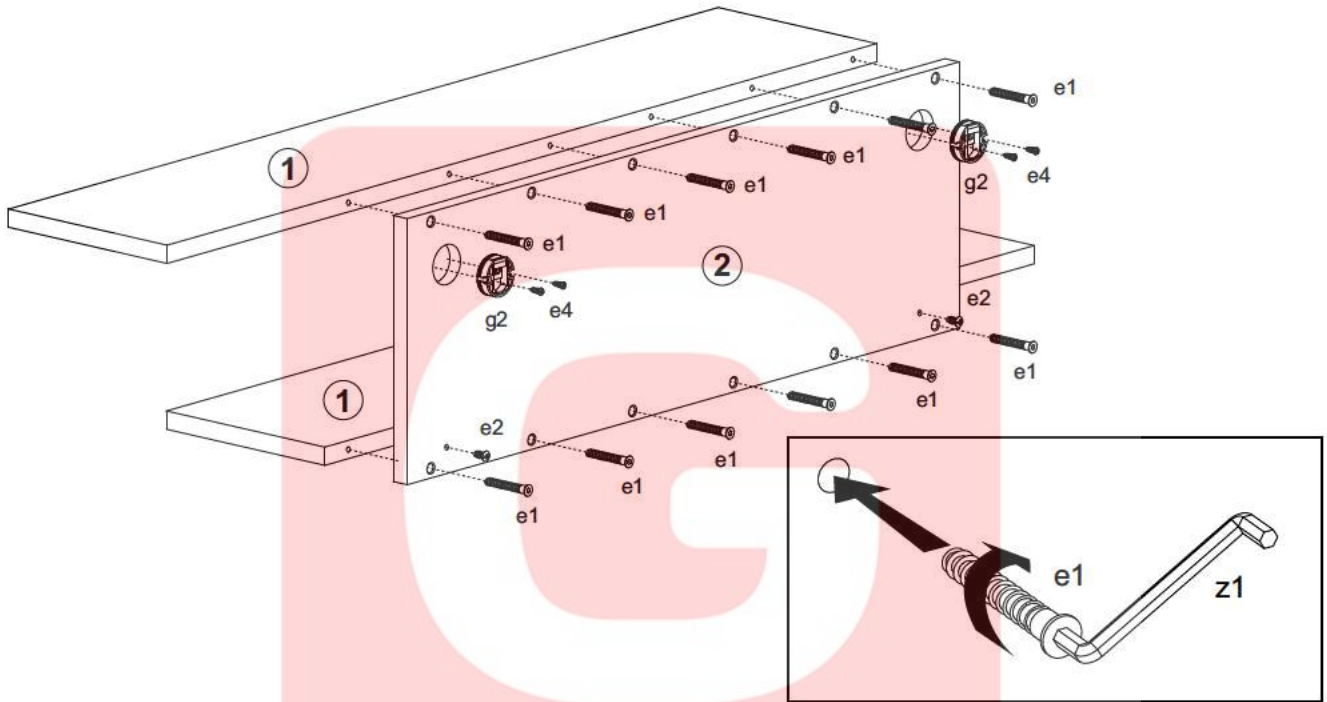

17

-
-
-
-

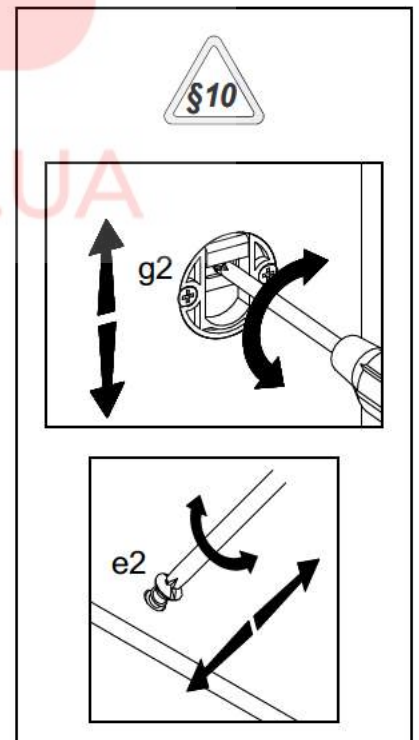
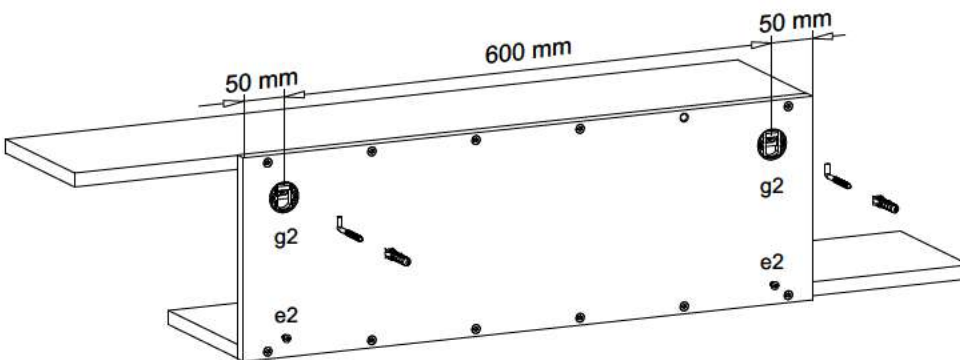
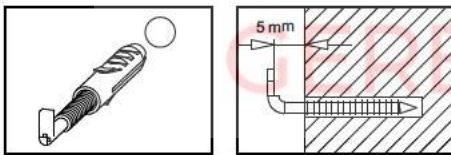

18

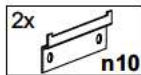

25 mm 64 mm

64 mm 25 mm

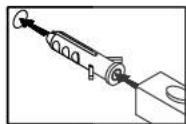
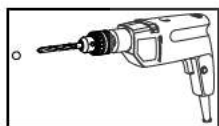
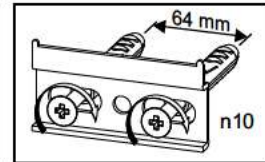
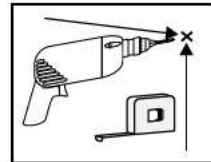

n14

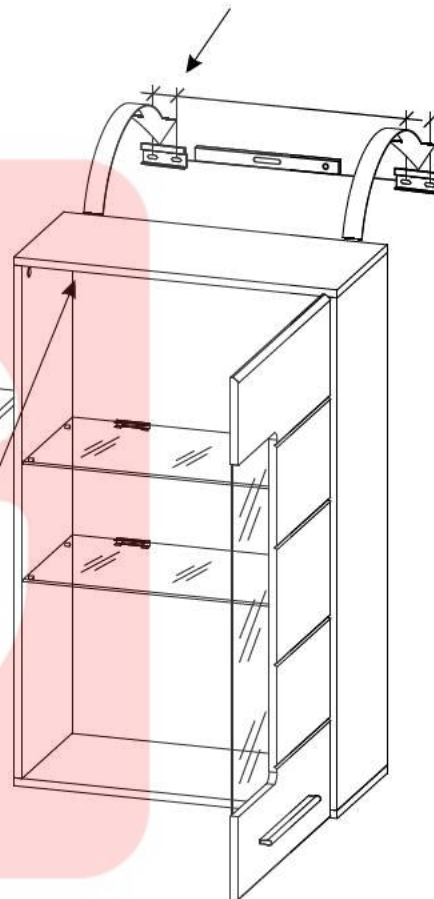
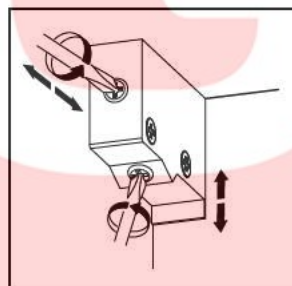
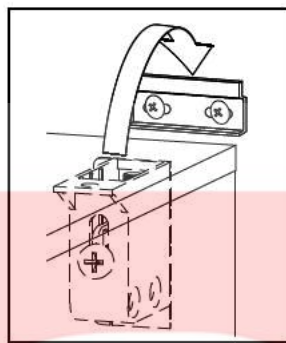

GERBOR.KIEV.UA

