

A	B	C		D
1	S301-155	287	235	1/1
2	S301-156	287	235	1/1
3	S301-157	287	235	1/1
4	S301-222	1200	236	1/1
5	S301-932	318	1195	1/1

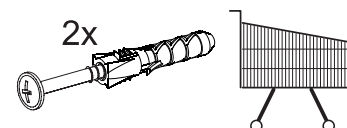

1

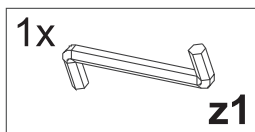
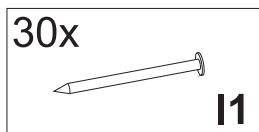
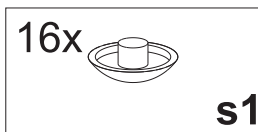
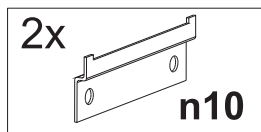
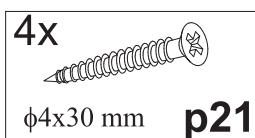
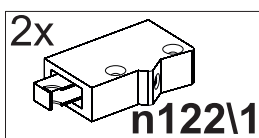
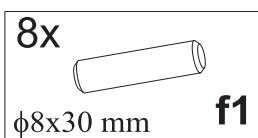
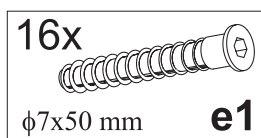
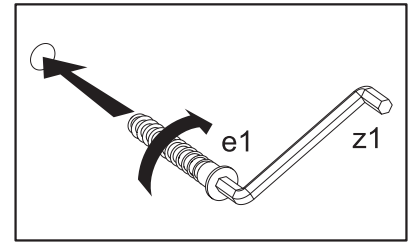
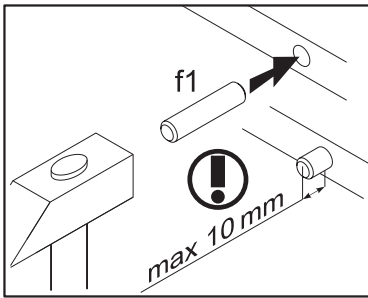
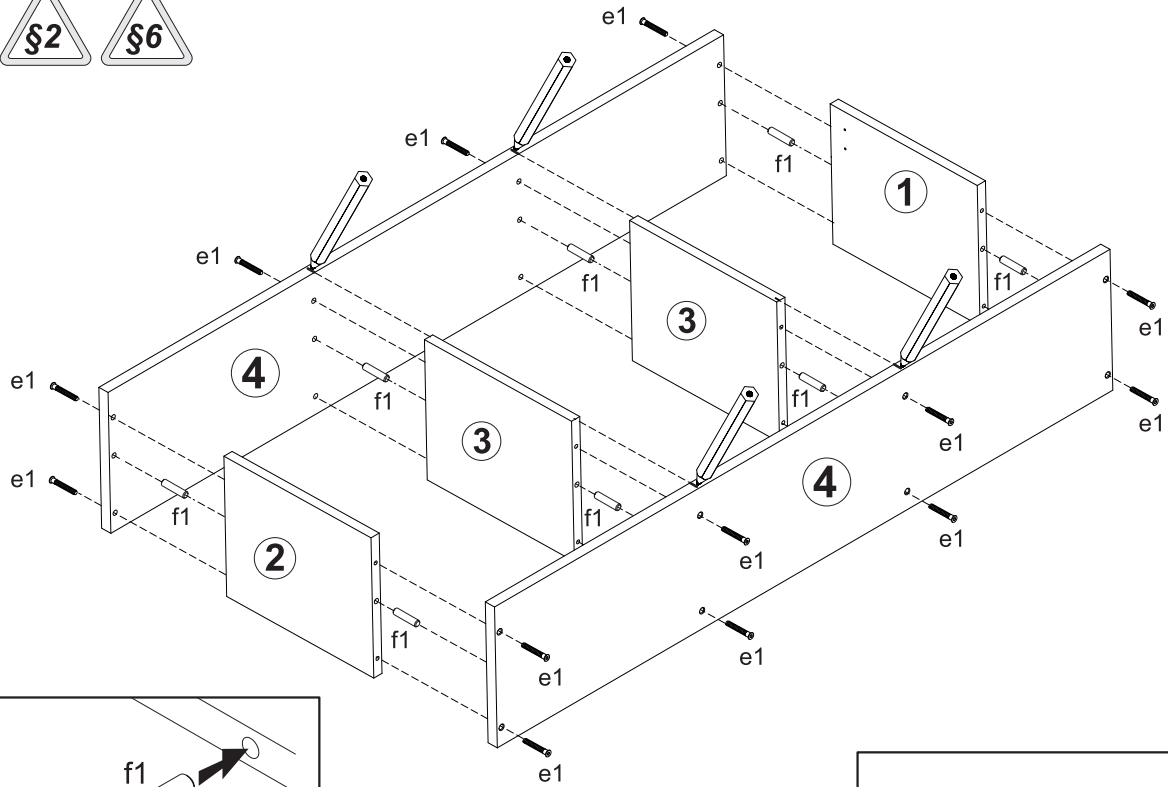

2

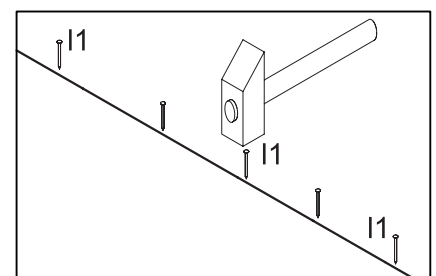
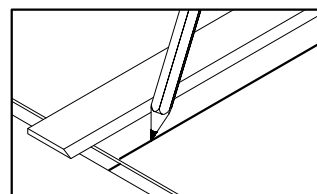
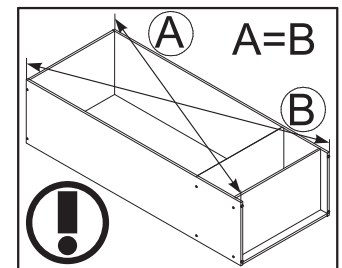
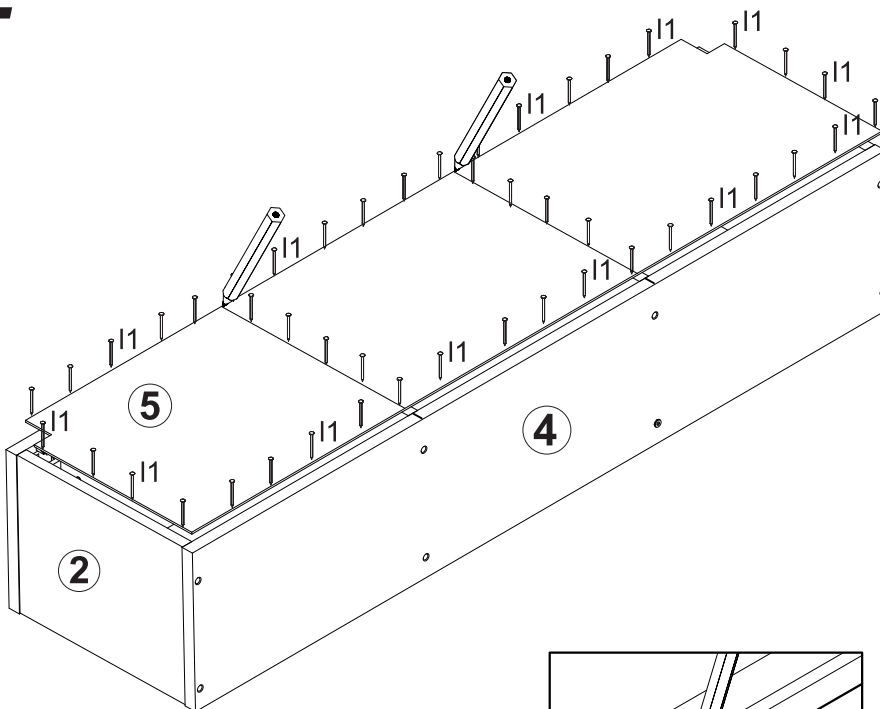

3

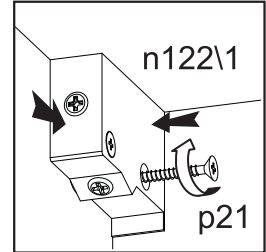
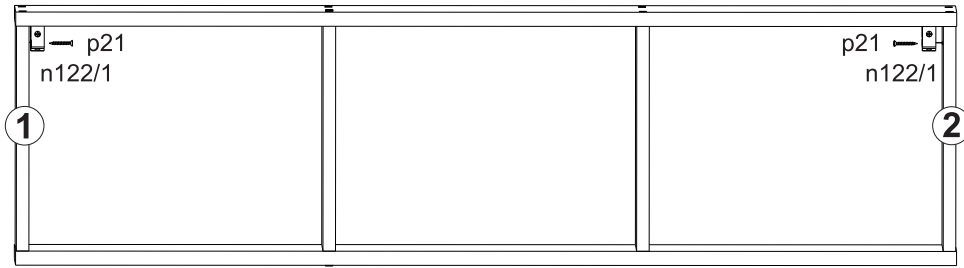

4

