

A	B	C	D	
1	S404-0033	1648	402	1/3
2	S404-0040	1648	900	2/3
3	S404-1031	2000	250	3/3
4	S404-1032	1603	200	3/3

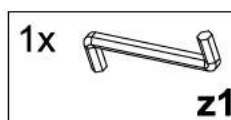

1

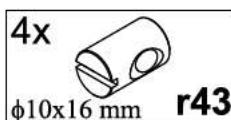
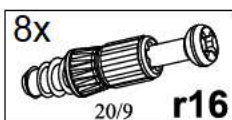
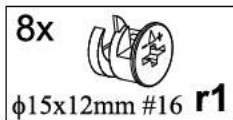
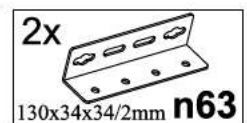
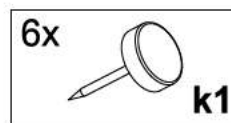
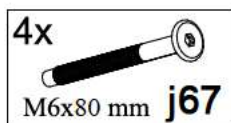
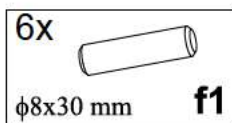
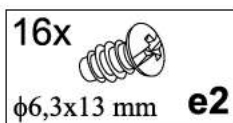
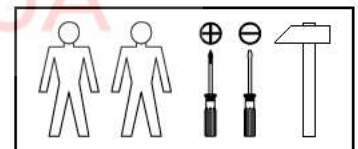
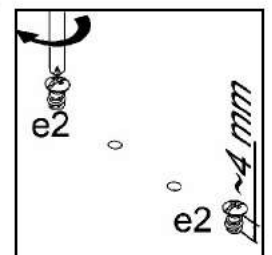
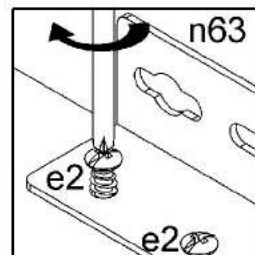
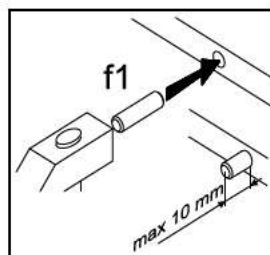
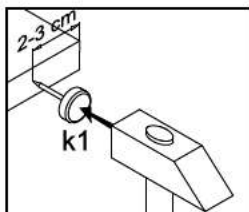
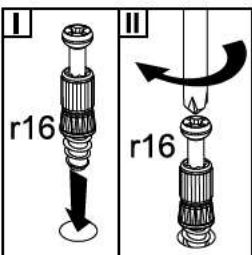
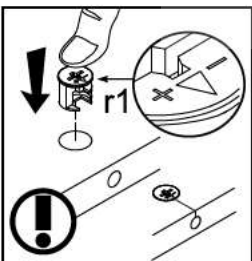
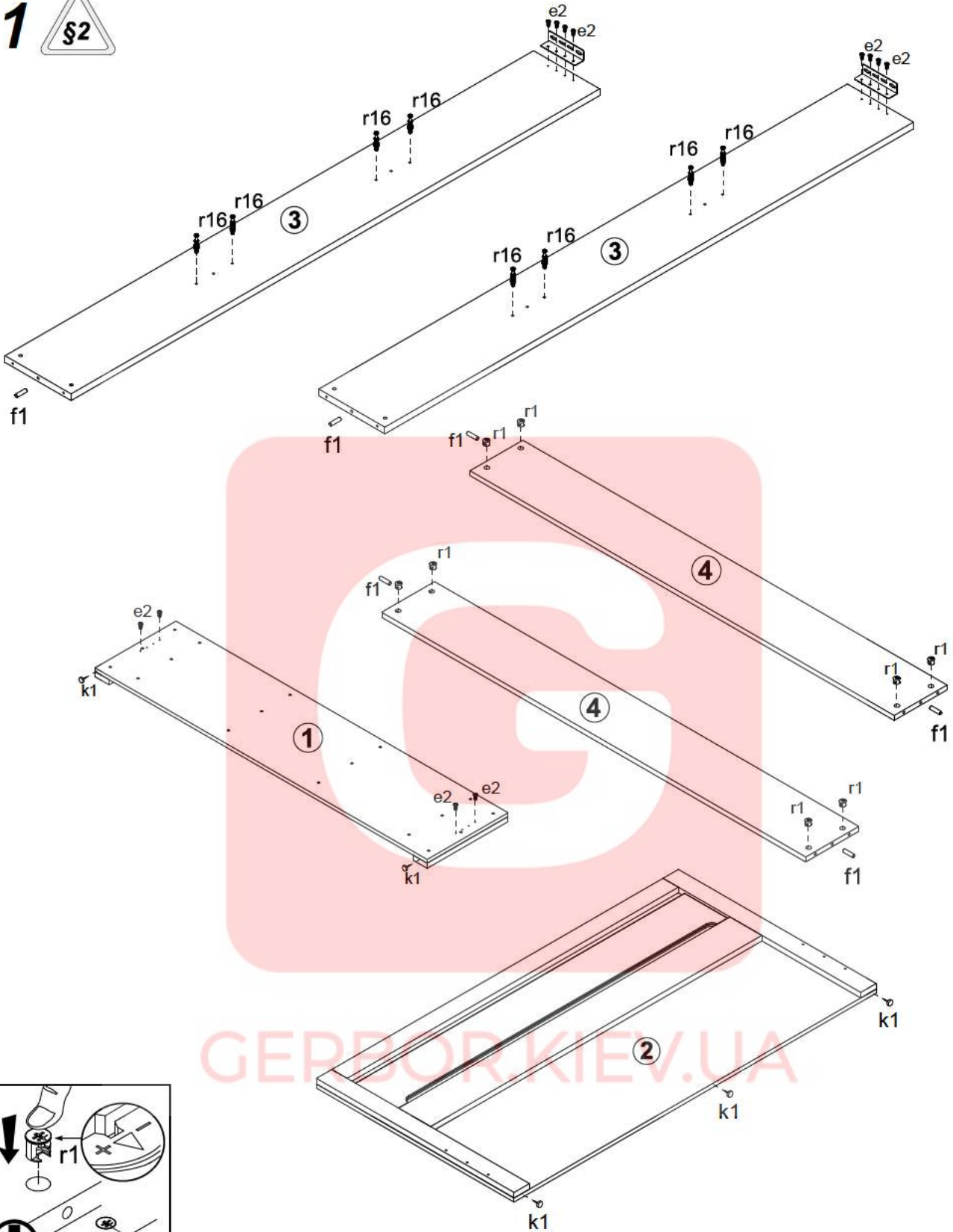

2

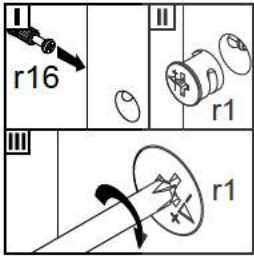
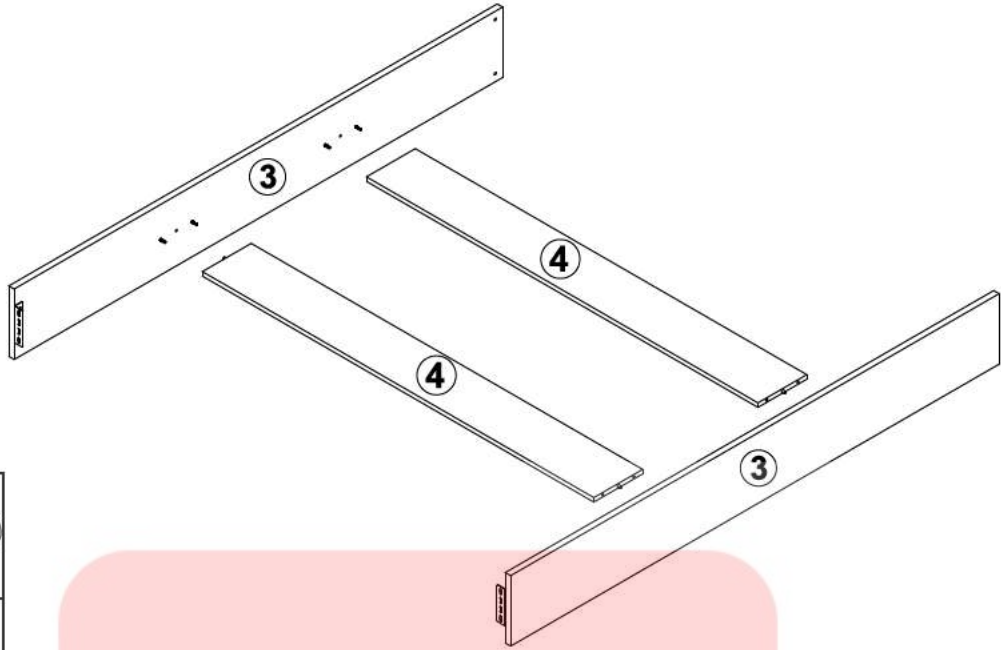

3

