

322 Series

POMPA ALBERO MASCHIO Solid shaft pump

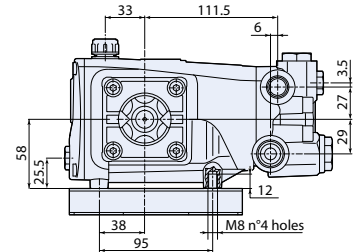

				
idropulitrici pressure washers	processi industriali industrial processes	autolavaggio car wash	agricoltura agriculture	cantieri ed edilizia construction industry

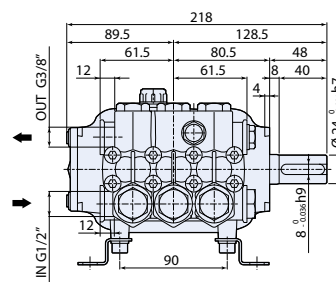
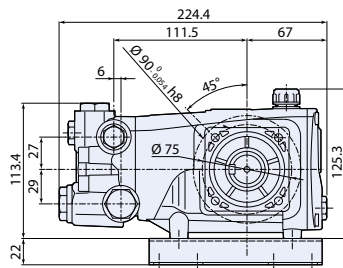

Piedi a richiesta.
Base on request.

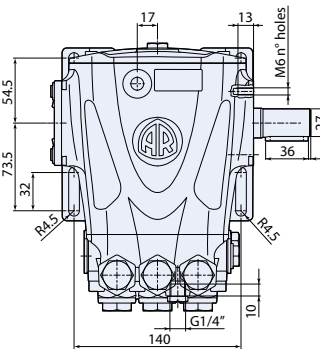





Model H

3228500

N version

Flangiatura compatibile XT N.
XT N flange type.

MOD	COD												
		MAX	MAX		NET	l/min	gpm	bar	psi	hp	kW	N° giri/1'	kg
RR 1450rpm Nversion Ø24mm													
RR 13.20 N	23771	13	3,43	200	2900	7,5	5,5	1450	7,6				
RR 15.15 N	23772	15	3,96	150	2200	5,5	4	1450	7,6				
RR 15.20 N	23507	15	3,96	200	2900	7,5	5,5	1450	7,6				
● RR 15.25 H N	■ 24934	15	3,96	250	3600	10	7,5	1450	8				
RR 18.12 N	23773	18	4,75	120	1740	5,5	4	1450	7,6				
RR 18.16 N	23774	18	4,75	160	2300	7,5	5,5	1450	7,6				
RRA 1750rpm Nversion Ø24mm													
RRA 3.5 G25 N	23779	13,2	3,5	170	2500	6	4,5	1750	7,6				
RRA 4 G30 N	23780	15,1	4	205	3000	8,2	5,5	1750	7,6				
● RRA 4 G36 H N	■ 24937	15,1	4	250	3600	8,6	6,4	1750	8				
RRA 5.5 G30 N	23781	20,8	5,5	205	3000	11	8,2	1750	7,6				



● testa nichelata
nickel plated
brass head



■ bielle in bronzo
connecting-rods
in bronze



testa in ottone
brass head



■ bielle in alluminio
connecting-rods
in aluminium