

Fuse Systems

DIAZED fuse systems, 5SA, 5SB, 5SC, 5SD

Overview

The DIAZED fuse system is one of the oldest fuse systems in the world. It was developed by Siemens as far back as 1906. It is still the standard fuse system in many countries to this day. It is particularly widely used in the harsh environments of industrial applications.

The series is available with rated voltages from 500 A to 750 V.

All DIAZED bases must be fed from the bottom to ensure an insulated threaded ring when the fuse link is being removed. Reliable contact of the fuse links is only ensured when used together with DIAZED screw adapters.

The terminals of the DIAZED bases are available in different versions and designs to support the various installation methods.

The high-performing EZR bus-mounting system for screw fixing is an outstanding feature. The busbars, which are particularly suited for bus-mounting bases, have a load capacity of up to 150 A with lateral infeed.

DIAZED stands for **D**iametral gestuftes **z**weiteiliges Sicherungssystem mit **E**disongewinde (diametral two-step fuse system with Edison screw).

Benefits

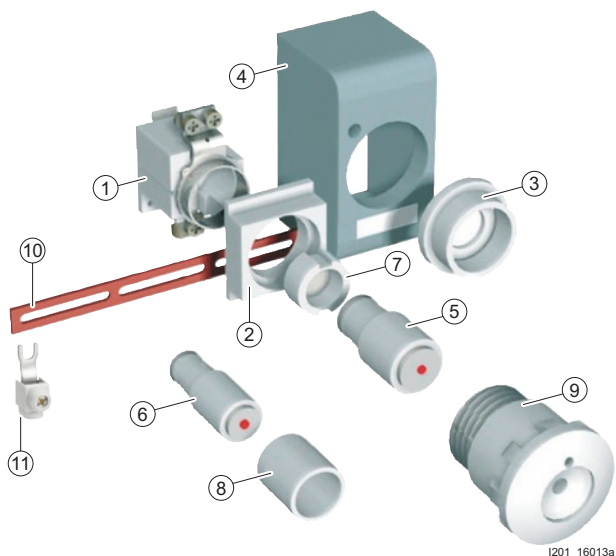

DIAZED fuse systems are a result of a well-designed modular system which enables the components to be combined in any way to meet the various requirements and to facilitate different installation methods.

- ① DIAZED bases
- ② DIAZED covers
- ③ DIAZED cover rings
- ④ DIAZED caps
- ⑤ DIAZED fuse links, DII
- ⑥ DIAZED fuse links, NDz
- ⑦ DIAZED screw adapters
- ⑧ DIAZED adapter sleeves
- ⑨ DIAZED screw caps
- ⑩ Busbars, oblong hole, single-phase
- ⑪ Terminal, fork-type terminal, non-insulated

Technical specifications

		5SA, 5SB, 5SC, 5SD	
Standards		IEC 60269-3; DIN VDE 0635; DIN VDE 0636-3; CEE 16	
Operational class	Acc. to IEC 60269; DIN VDE 0636	gG	
Characteristic	Acc. to DIN VDE 0635	Slow and quick	
Rated voltage U_n	V AC	500, 690, 750	
	V DC	500, 600, 750	
Rated current I_n	A	2 ... 100	
Rated breaking capacity	kA AC	50, 40 at E16	
	kA DC	8, 1.6 at E16	
Mounting position		Any, but preferably vertical	
Non-interchangeability		Using screw adapter or adapter sleeves	
Degree of protection	Acc. to IEC 60529	IP20, with connected conductors	
Resistance to climate	°C	Up to 45, at 95 % rel. humidity	
Ambient temperature	°C	-5 ... +40, humidity 90 % at 20	

		Terminal version									
		B			K			S		R	
Size		DII	DIII	NDz	DII	DIII	DIII	DIV	DII	DIII	
Conductor cross-sections											
• Rigid, min.	mm ²	1.5	2.5	1.0	1.5	2.5	2.5	10	1.5	1.5	
• Rigid, max.	mm ²	10	25	6	10	25	25	50	35	35	
• Flexible, with end sleeve	mm ²	10	25	6	10	25	25	50	35	35	
Tightening torques											
• Screw M4	Nm	1.2							--		
• Screw M5	Nm	2.0							--		
• Screw M6	Nm	2.5							4		
• Screw M8	Nm	3.5							--		

Dimensional drawings

DIAZED fuse links

5SA1, 5SA2

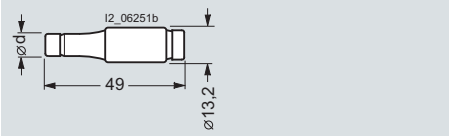

5SB1, 5SB2

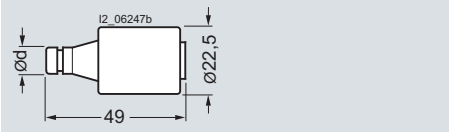

5SB3, 5SB4

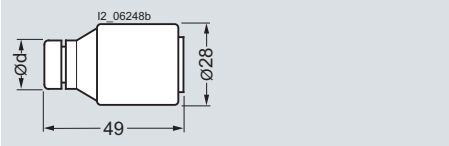

5SC1, 5SC2

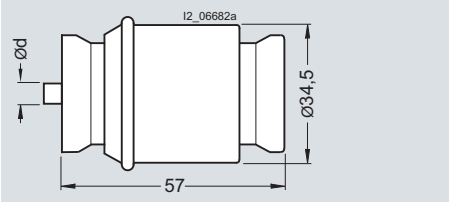

5SD6, 5SD8

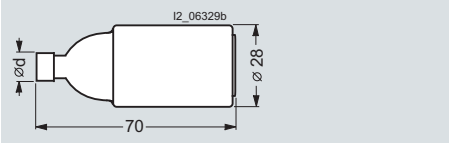

Size/thread	TNDz/E16, NDz/E16						
Rated current in A	2	4	6	10	16	20	25
Dimension d	6	6	6	8	10	12	14

Size/thread	DII/E27						
Rated current in A	2	4	6	10	16	20	25
Dimension d	6	6	6	8	10	12	14

Size/thread	DIII/E33			
Rated current in A	32	35	50	63
Dimension d	16	16	18	20

Size/thread	DIV/R1¼"	
Rated current in A	80	100
Dimension d	5	7

Size/thread	DIII/E33									
Rated current in A	2	4	6	10	16	20	25	35	50	63
Dimension d	6	6	6	8	10	12	14	16	18	20

Fuse Systems

DIAZED fuse systems, 5SA, 5SB, 5SC, 5SD

DIAZED fuse bases made of ceramic

5SF1

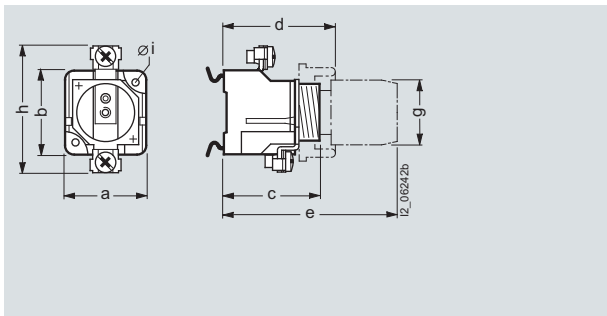

5SF4 230

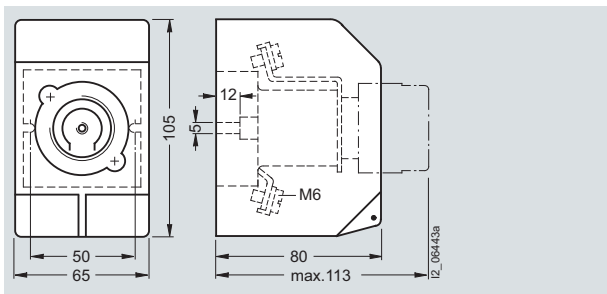

5SF5

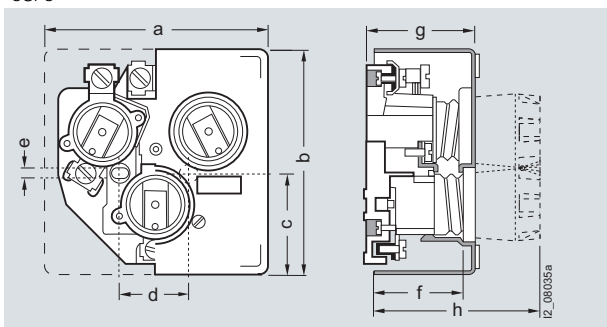

Version	Connection type	Dimensions							
		a	b	c	d	e	Øg	h	Øi
NDz/25 A									
5SF1 012	KK	29	49	44.6	55	75	32	49	--
5SF1 01	KK	29	49	44.6	55	75	32	49	4.2
DII/25 A									
5SF1 005	BB	38.4	41	46.6	53	83	34	63	--
5SF1 024	BB	38.4	41	46.6	53	83	34	63	4.3
DIII/63 A									
5SF1 205	BS	45.5	46	47	54	83	43	78	--
5SF1 215	SS	45.5	46	47	54	83	43	78	--
5SF1 224	BS	45.5	46	47	54	83	43	78	4.3
5SF1 214	SS	45.5	46	47	54	83	43	78	4.3
DIV/100 A									
5SF1 401	Flat terminal	68	68	--	79	110	65	116	6.5

Version	Connection type	Dimensions							
		a	b	c	d	e	f	g	h
DII/3 × 25 A									
5SF5 067	BB	106	106	48	--	--	45	52	86
5SF5 066	KB	106	106	48	32	5.2	45	52	86
DIII/3 × 63 A									
5SF5 237	BB	127	130	54	--	--	45	52	85
5SF5 236	KB	127	130	54	32	5.2	45	52	85

DIAZED fuse bases made of molded plastic

5SF1, 5SF5

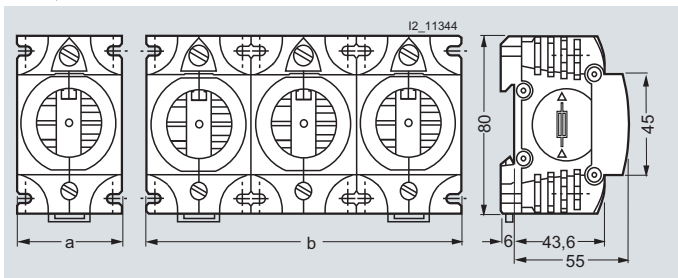

Type	Dimensions	
	a	b
5SF1 060	40	--
5SF1 260	50	--
5SF5 068	--	120
5SF5 268	--	150

DIAZED fuse systems, 5SA, 5SB, 5SC, 5SD

DIAZED EZR bus-mounting bases

5SF6 005

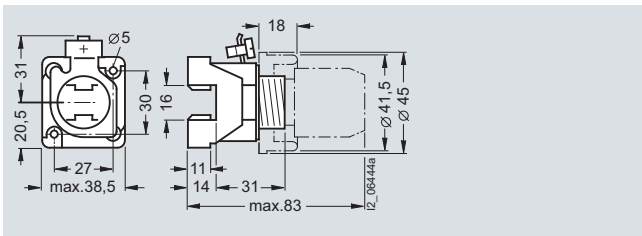

5SF6 205

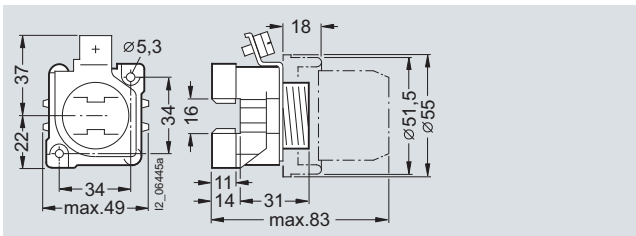

DIAZED screw caps/cover rings made of molded plastic/ceramic

Screw caps

5SH1

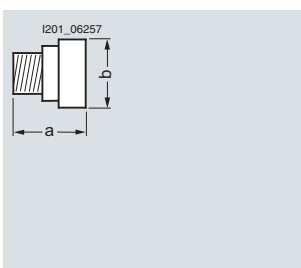

Cover rings

5SH3

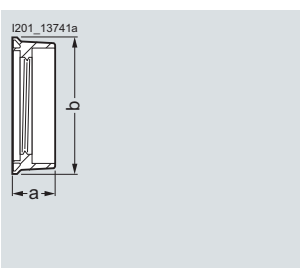

Size/thread	Screw caps			Cover rings		
	Type	Dimensions a	Øb	Type	a	Øb
NDz/E16	5SH1 112	36	24			
DII/E27	5SH1 221	42	33	5SH3 401	17.5	39.5
	5SH1 12	45.5	34	5SH3 32	17.5	41.5
	5SH1 22	43	39			
DIII/E33	5SH1 231	42	40	5SH3 411	17.5	49.5
	5SH1 13	45.5	43	5SH3 34	19	51.5
	5SH1 23	47	45			
	5SH1 161	48	48			
	5SH1 170	68	43			
DIV/R1¼"	5SH1 141	53	65			

DIAZED cover made of molded plastic

5SH2

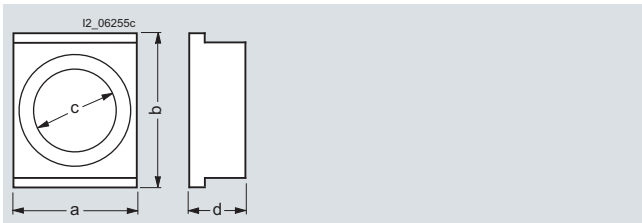

Size/thread	Type	Dimensions			
		a	b	Øc	d
DII/E27	5SH2 032	41	51	27.5	19
DIII/E33	5SH2 232	52	51	34.5	18.5

DIAZED caps made of molded plastic

5SH2

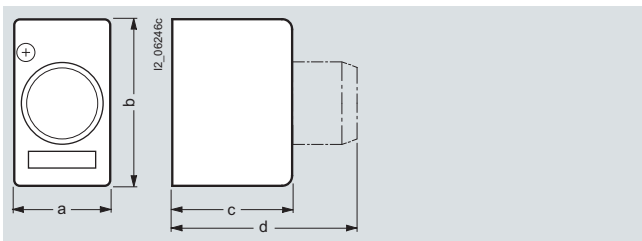

Size/thread	Type	Dimensions			
		a _{max}	b _{max}	c _{max}	d _{max}
NDz/E16	5SH2 01	33	68	51.7	75
DII/E27	5SH2 02	43	74.7	53.6	83
DIII/E33	5SH2 22	51	90.5	53.6	83

Fuse Systems

**DIAZED fuse systems,
5SA, 5SB, 5SC, 5SD**

Characteristic curves

Series 5SA2

Size: E16
 Characteristic: slow
 Rated voltage: 500 V AC/500 V DC
 Rated current: 2 ... 25 A

Time/current characteristics diagram

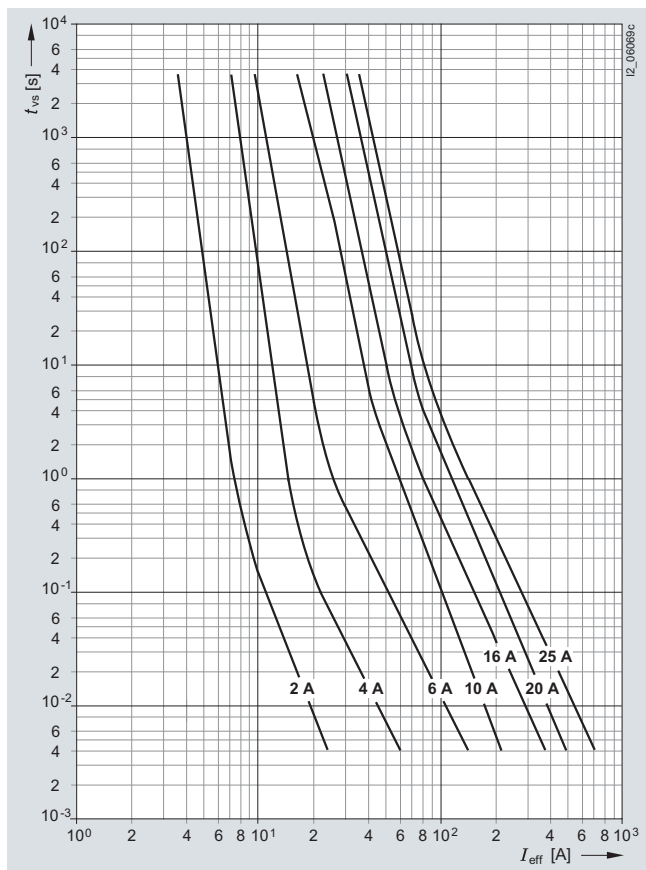

Melting I^2t values diagram

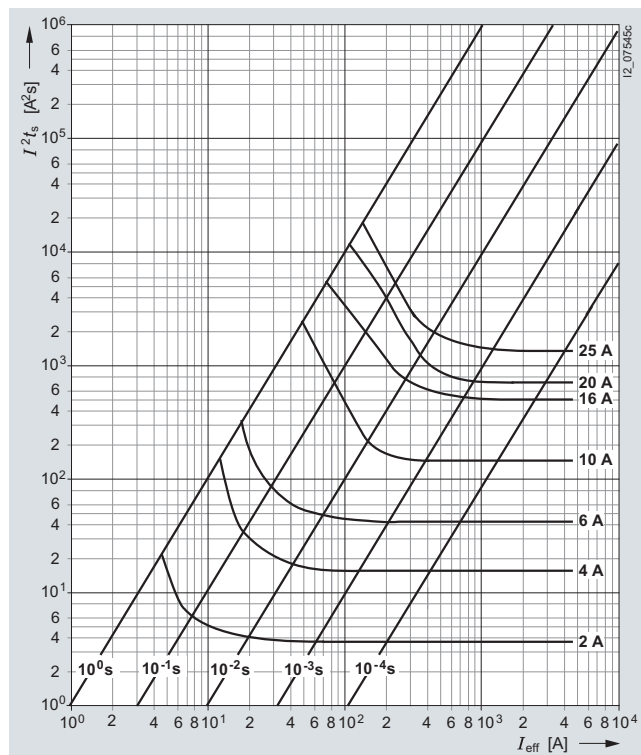

Current limitation diagram

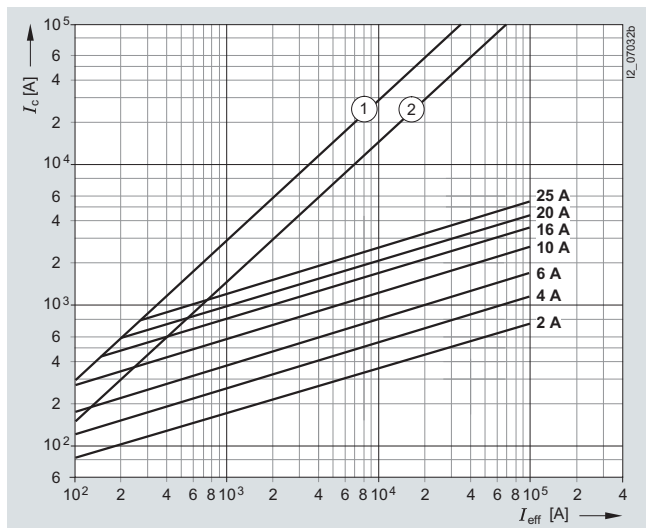

- ① Peak short-circuit current with largest DC component
- ② Peak short-circuit current without DC component

Type	I_n A	P_v W	$\Delta\theta$ K	I^2t_s 1 ms A ² s	4 ms A ² s
5SA2 11	2	0.85	15	1.2	2.3
5SA2 21	4	1.3	17	8.5	13
5SA2 31	6	1.9	14	40	80
5SA2 51	10	1.4	17	200	190
5SA2 61	16	2.4	30	290	550
5SA2 71	20	2.6	36	470	1990
5SA2 81	25	3.4	34	1000	2090

Type	I^2t_a 230 V AC A ² s	320 V AC A ² s	500 V AC A ² s
5SA2 11	6.6	7.8	0.7
5SA2 21	22	26	34
5SA2 31	66	76	100
5SA2 51	240	270	340
5SA2 61	890	950	1090
5SA2 71	1200	1350	1620
5SA2 81	2400	2600	3450

Series 5SA1

Size: E16
 Characteristic: quick
 Rated voltage: 500 V AC/500 V DC
 Rated current: 2 ... 25 A

Time/current characteristics diagram

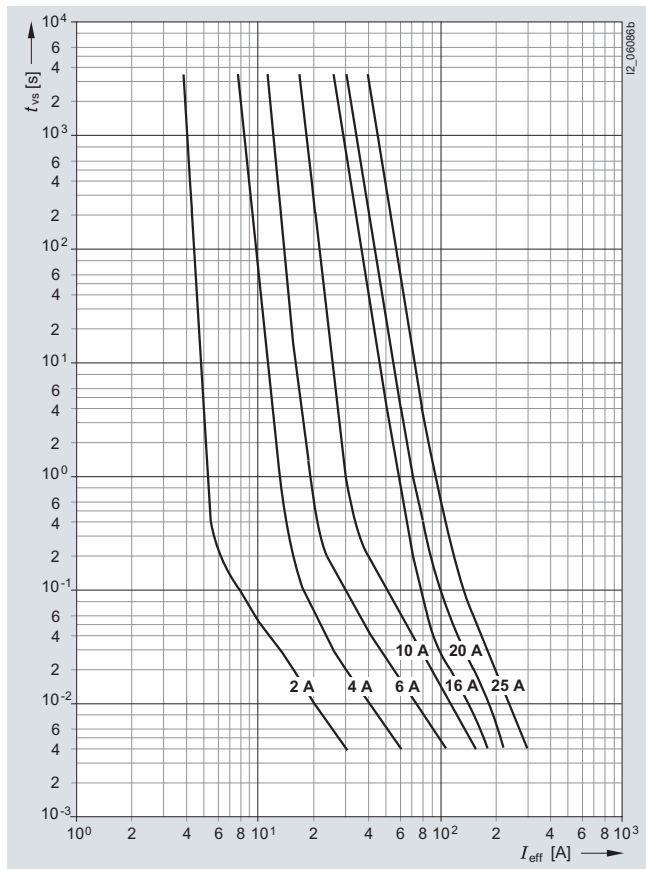

Melting I^2t values diagram

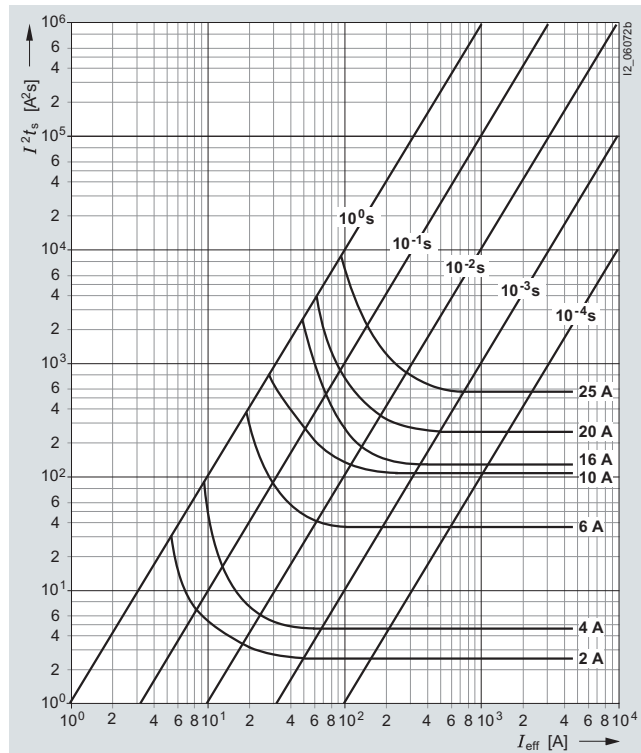

Current limitation diagram

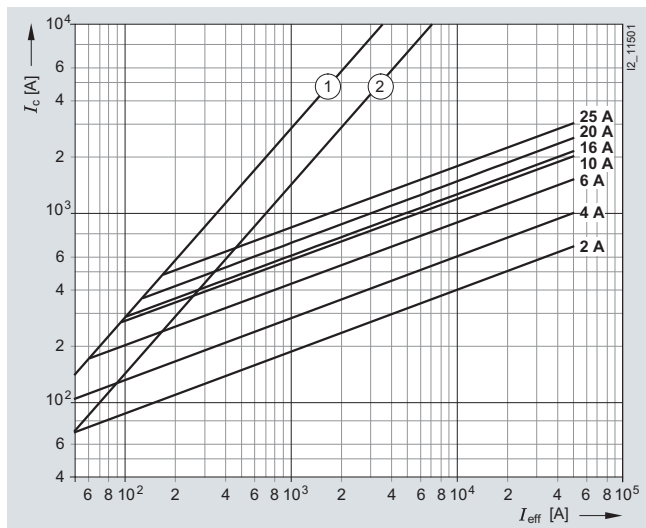

- ① Peak short-circuit current with largest DC component
- ② Peak short-circuit current without DC component

Type	I_n A	P_V W
5SA1 11	2	1.5
5SA1 21	4	1.9
5SA1 31	6	2.7
5SA1 51	10	3.4
5SA1 61	16	3.7
5SA1 71	20	4.4
5SA1 81	25	4.9

Fuse Systems

DIAZED fuse systems, 5SA, 5SB, 5SC, 5SD

Series 5SB2, 5SB4, 5SC2

Size: DII, DIII, DIV
 Operational class: gG
 Rated voltage: 500 V AC/500 V DC
 Rated current: 2 ... 100 A

Time/current characteristics diagram

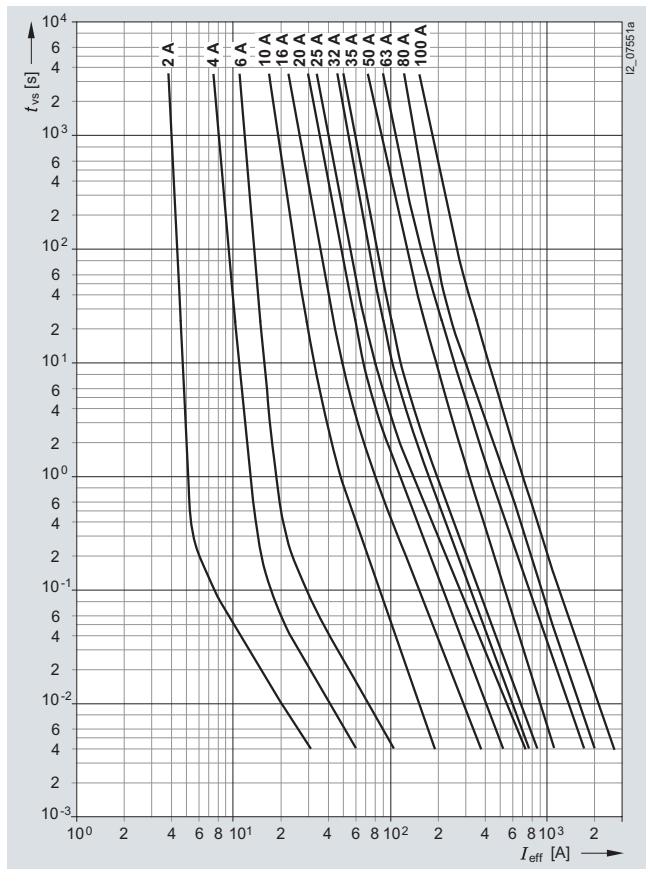

Melting I²t values diagram

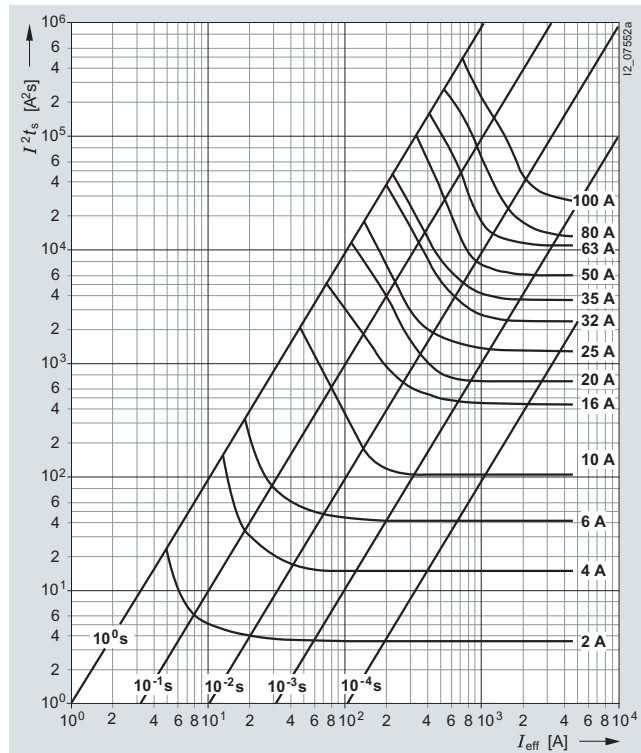

Current limitation diagram

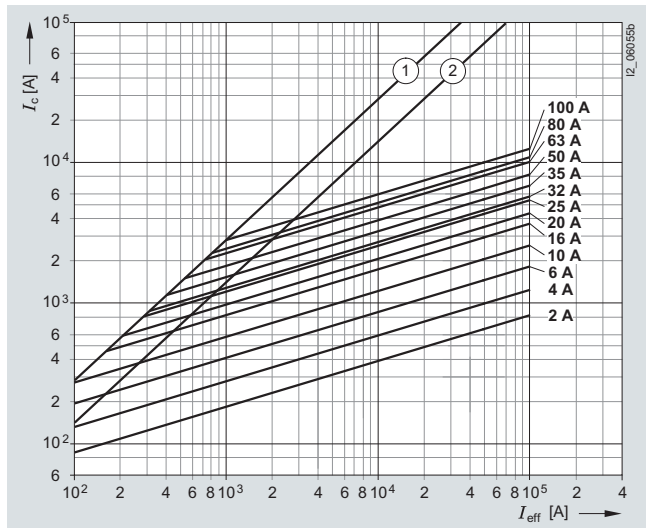

- ① Peak short-circuit current with largest DC component
- ② Peak short-circuit current without DC component

Type	I_n	P_v	$\Delta\theta$	I^2t_s	
	A	W	K	1 ms A ² s	4 ms A ² s
5SB2 11	2	2.6	15	3.7	3.9
5SB2 21	4	2.0	13	15	16
5SB2 31	6	2.2	14	42	45
5SB2 51	10	1.6	20	120	140
5SB2 61	16	2.4	23	500	580
5SB2 71	20	2.6	26	750	1100
5SB2 81	25	3.4	38	1600	2000
5SB4 010	32	3.6	23	2300	2500
5SB4 11	35	3.7	25	3450	3000
5SB4 21	50	5.7	41	6500	5200
5SB4 31	63	6.9	48	11000	12000
5SC2 11	80	7.5	33	14600	16400
5SC2 21	100	8.8	46	28600	30000

Type	I^2t_a		
	230 V AC A ² s	320 V AC A ² s	500 V AC A ² s
5SB2 11	6.6	8.8	10.7
5SB2 21	22	28	34
5SB2 31	66	85	100
5SB2 51	240	300	340
5SB2 61	890	1060	1090
5SB2 71	1200	1450	1620
5SB2 81	2400	3150	3450
5SB4 010	3450	4150	4850
5SB4 11	5200	6200	7200
5SB4 21	9750	12350	14500
5SB4 31	16500	22200	26500
5SC2 11	23000	28500	32500
5SC2 21	44000	56000	65000

Series 5SB1, 5SB3, 5SC1

Size: DII, DIII, DIV
 Operational class: quick
 Rated voltage: 500 V AC/500 V DC
 Rated current: 2 ... 100 A

Time/current characteristics diagram

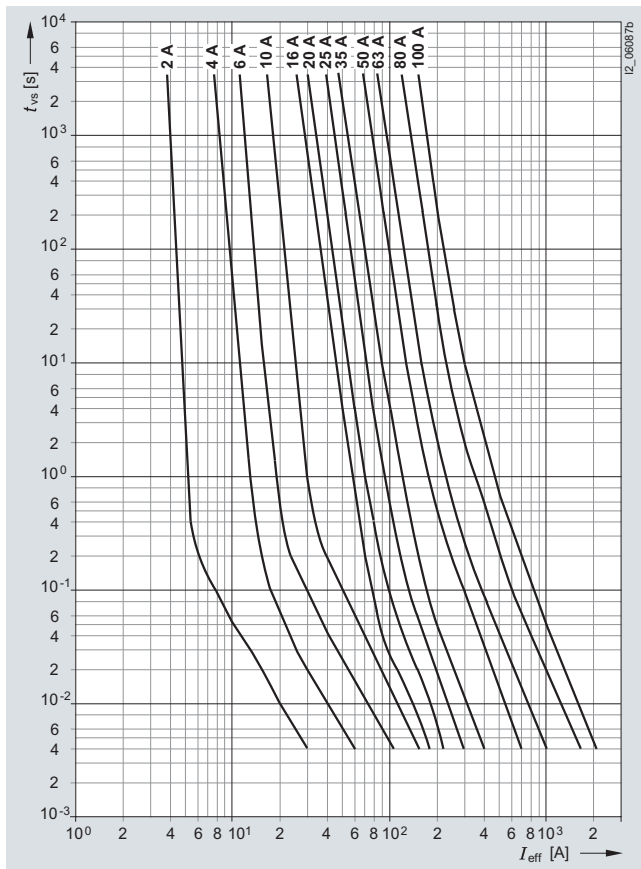

Melting I^2t values diagram

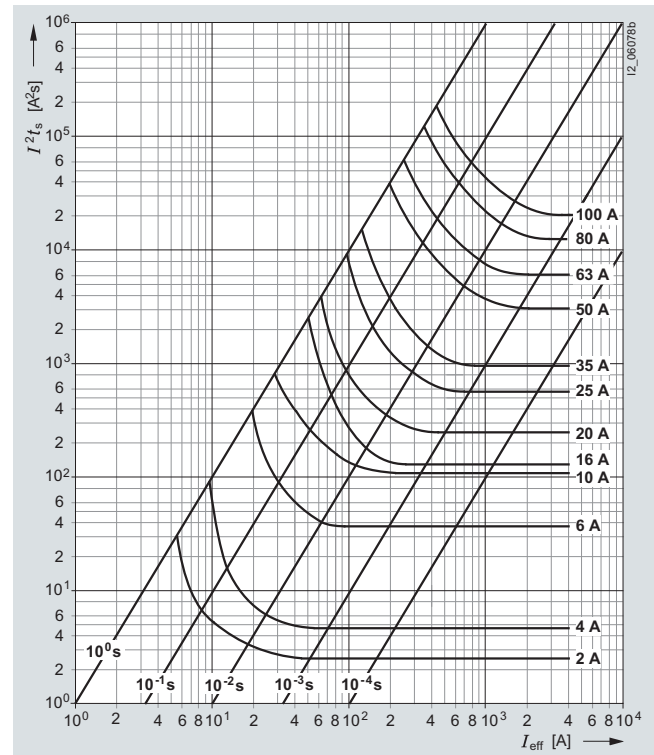

Current limitation diagram

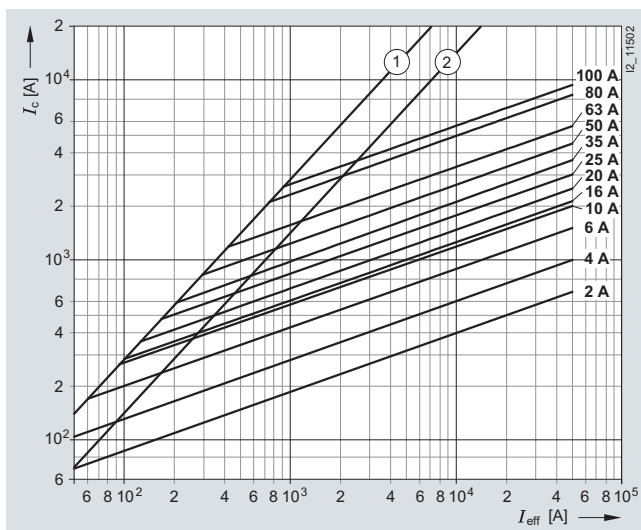

- ① Peak short-circuit current with largest DC component
- ② Peak short-circuit current without DC component

Type	I_n A	P_v W	$\Delta\theta$ K	I^2t_s 4 ms A ² s	I^2t_a 500 V AC A ² s
5SB1 11	2	1.5	3	2.5	5
5SB1 21	4	1.9	13	15.6	31.2
5SB1 31	6	2.7	18	36	72
5SB1 41, 5SB1 51	10	3.4	23	102	204
5SB1 61	16	3.7	24	130	260
5SB1 71	20	4.4	31	185	370
5SB1 81	25	4.9	34	250	500
5SB3 11	35	8.3	39	640	1280
5SB3 21	50	9.9	49	1960	3920
5SB3 31	63	12.8	63	3880	7760
5SC1 11	80	12.7	45	10890	21780
5SC1 21	100	15.4	55	17400	34800

Fuse Systems

DIAZED fuse systems, 5SA, 5SB, 5SC, 5SD

Series 5SD8

Size: DIII
 Operational class: gG
 Rated voltage: 690 V AC/600 V DC
 Rated current: 2 ... 63 A

Time/current characteristics diagram

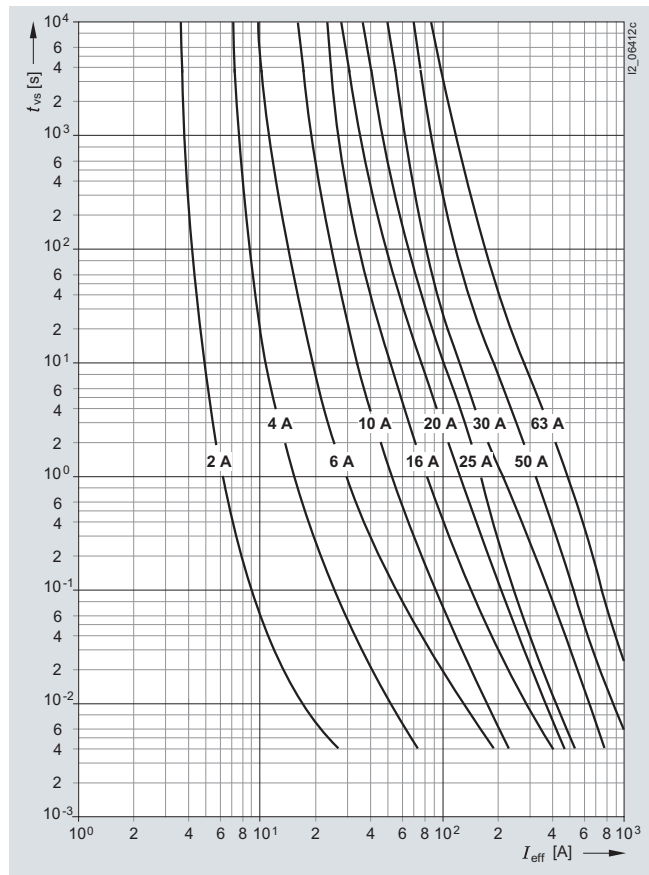

Melting I²t values diagram

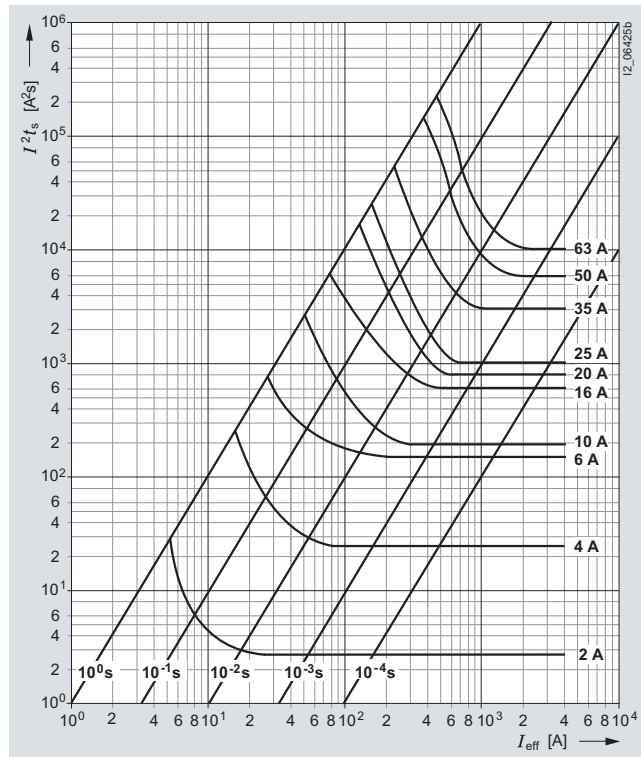

Current limitation diagram

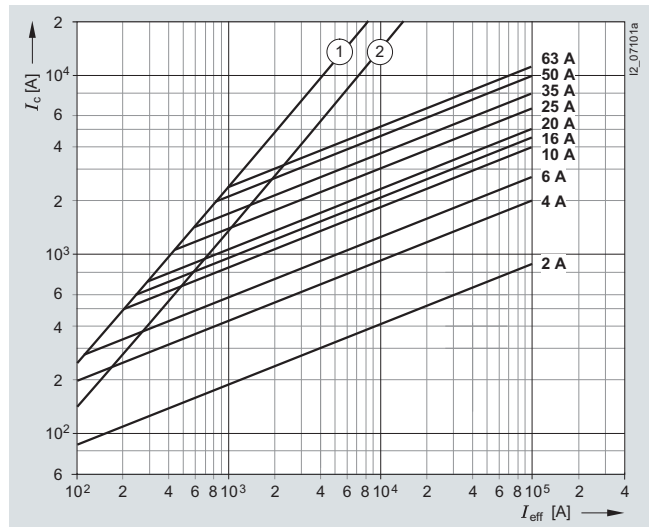

- ① Peak short-circuit current with largest DC component
- ② Peak short-circuit current without DC component

Type	I_n A	P_v W	$I^2 t_s$ 4 ms A ² s	$I^2 t_a$ 242 V AC A ² s
5SD8 002	2	1	4.4	7
5SD8 004	4	1.2	40	62
5SD8 006	6	1.6	88	140
5SD8 010	10	1.4	240	380
5SD8 016	16	1.8	380	600
5SD8 020	20	2	750	1200
5SD8 025	25	2.3	2000	3200
5SD8 035	35	3.1	3300	5100
5SD8 050	50	4.6	7000	11000
5SD8 063	63	5.5	9500	15000

Series 5SD6

Size: DIII
Operational class: quick (railway network protection)
Rated voltage: 750 V AC/750 V DC
Rated current: 2 ... 63 A

Time/current characteristics diagram

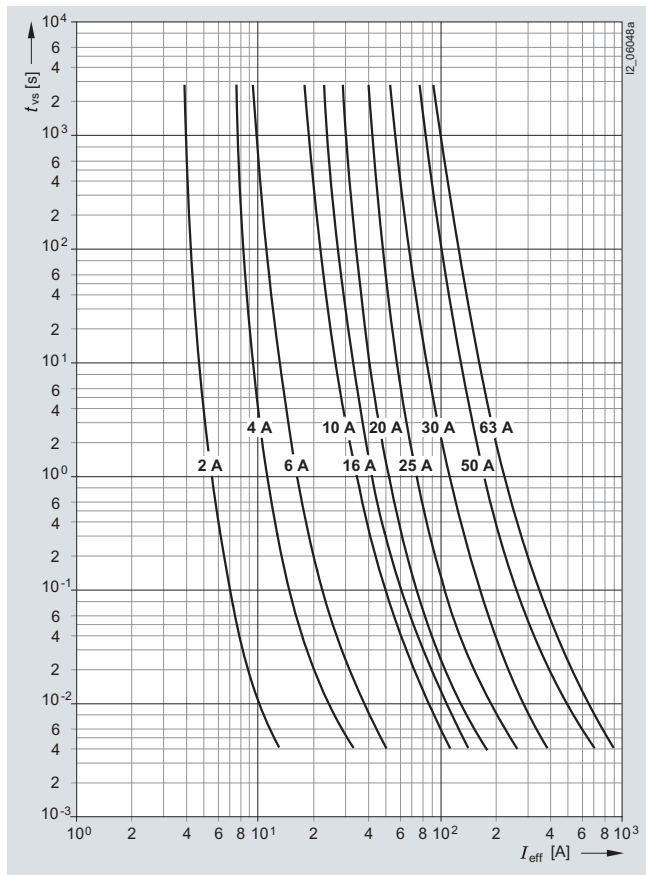

Melting I^2t values diagram

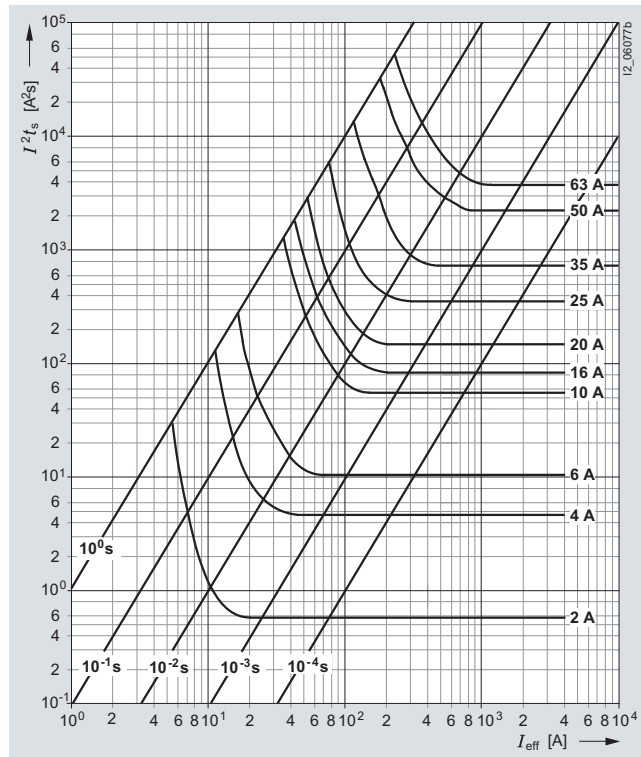

Current limitation diagram

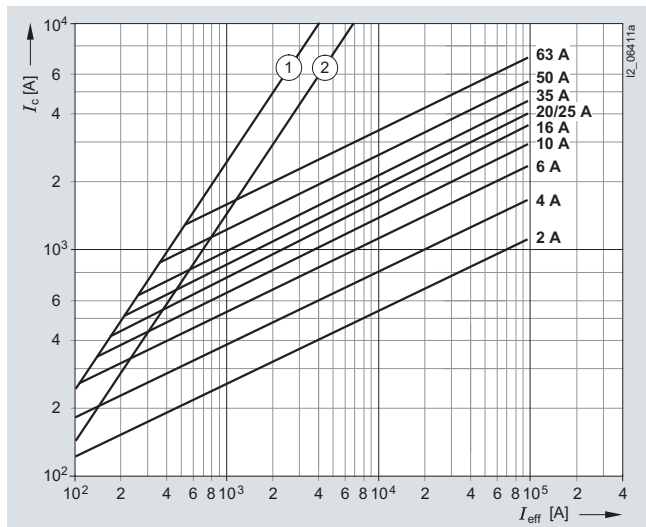

- ① Peak short-circuit current with largest DC component
- ② Peak short-circuit current without DC component

Type	I_n A	P_v W	I^2t_s 4 ms A ² s	I^2t_a 500 V AC A ² s
5SD6 01	2	2.8	0.7	2
5SD6 02	4	4	4.5	13
5SD6 03	6	4.8	10	29
5SD6 04	10	4.8	50	135
5SD6 05	16	5.9	78	220
5SD6 06	20	6.3	125	380
5SD6 07	25	8.3	265	800
5SD6 08	35	13	550	1600
5SD6 10	50	16.5	1800	5500
5SD6 11	63	18	3100	9600