

Rozmery v mm
Maße in mm
Dimensions in mm

BASIC 2g 70.44.01

146kg

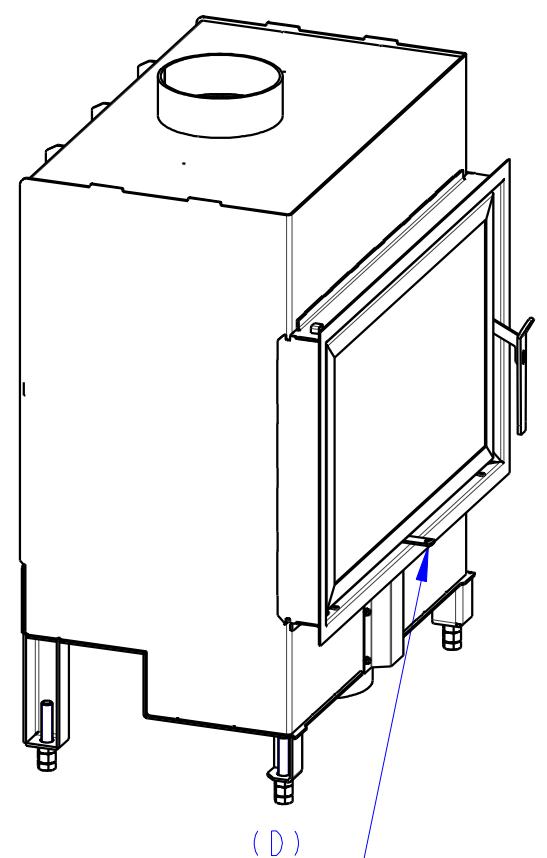
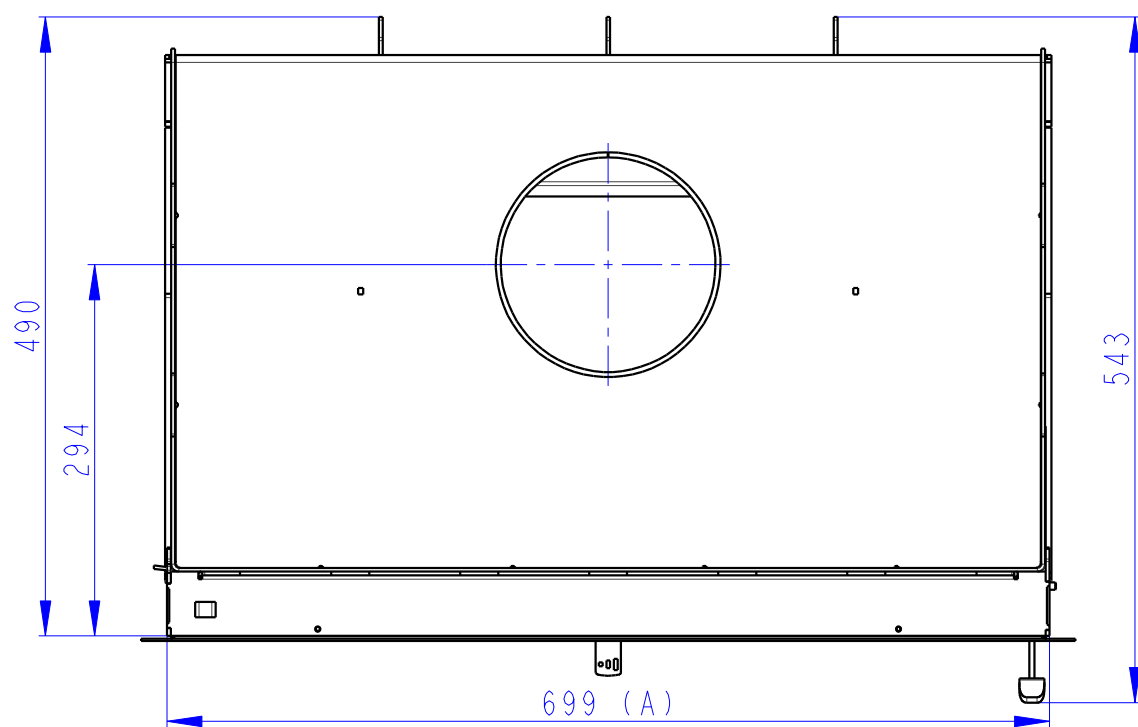
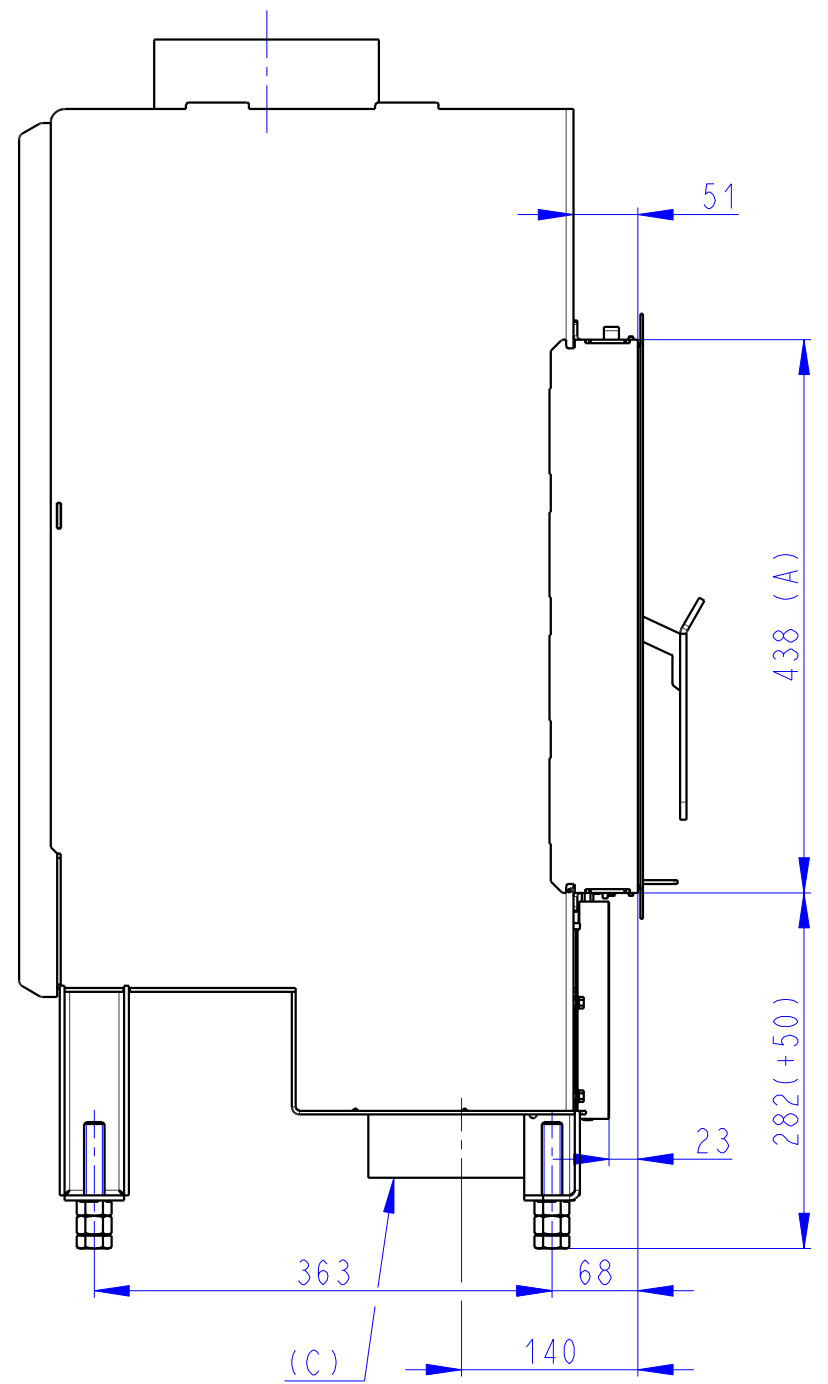
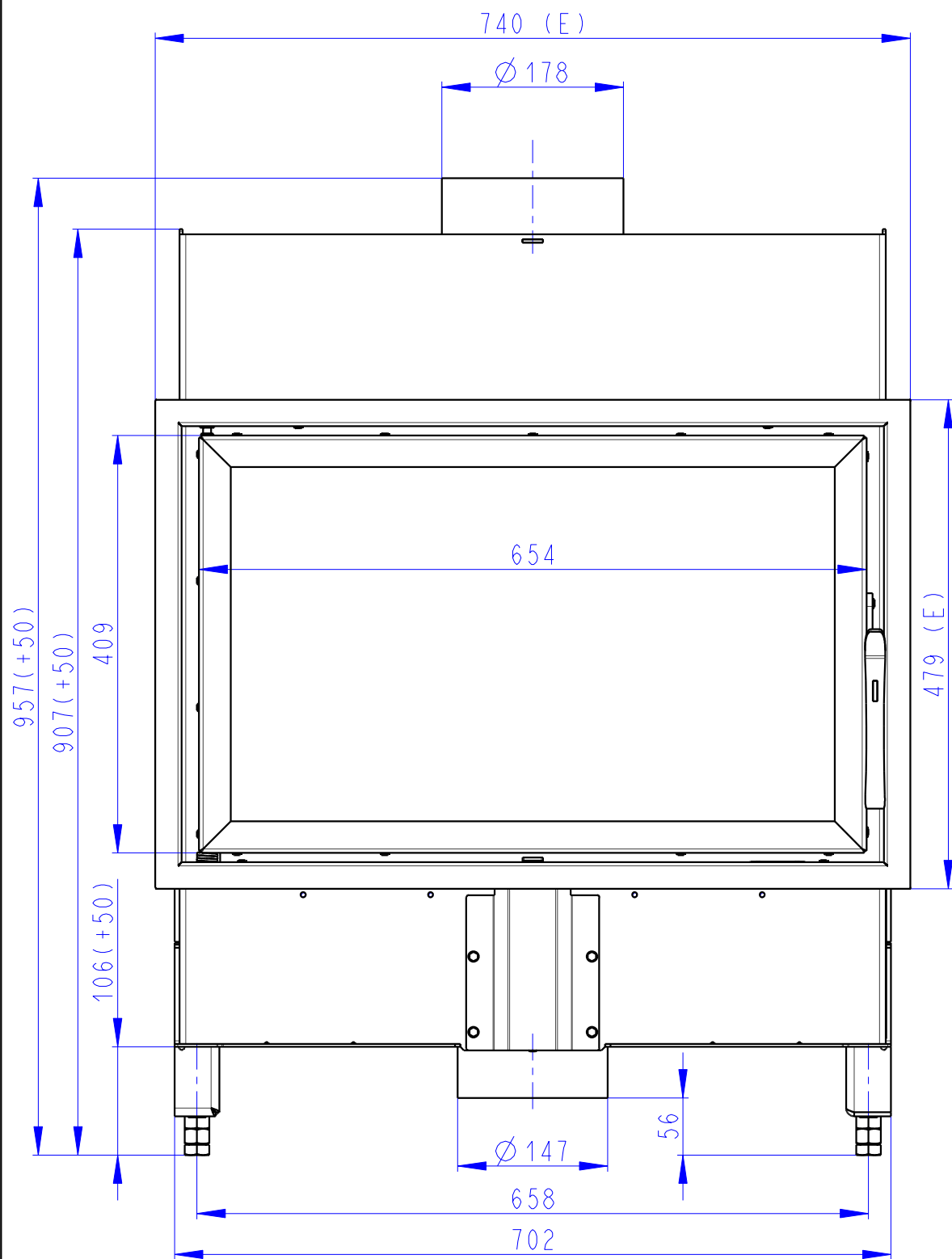

- (A) Zastavbovy rozmer / Baumaße / In-built dimension
 (C) Centralni privod vzduchu / Central air inlet / Zentralluftzufuhr
 (D) Primarni a sekundarni vzduch / Primary and secondary air / Primärluft und Sekundärluft
 (E) Ramek / Frame / Rahmen