

# Quick Start Guide

2.8 inches Color Screen Facial Recognition Series

Version: 1.0      Date: 2017.3

# 1. Overview

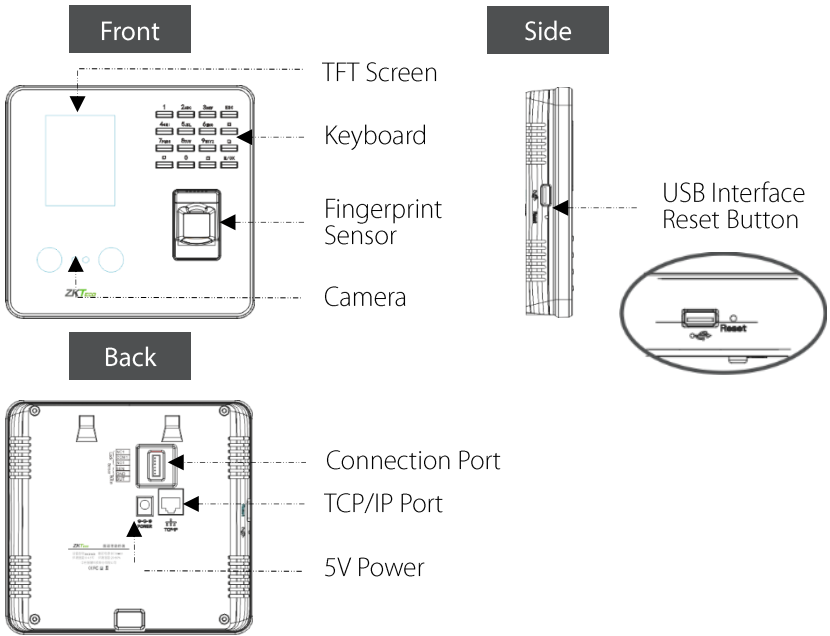

# 2. Installation Environment

## 1) Recommended Installation Location

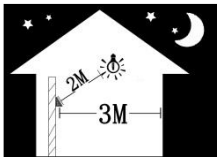

10Lux

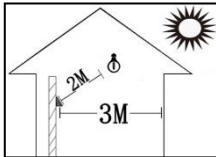

1200+ Lux

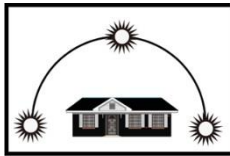

Install the device indoor at least 10 feet (3m) away from windows, and 6.5 feet (2m) away from light fixtures. Preferable light intensity should range between 0-800 LUX.

0-800Lux



## 2) NOT Recommended Locations:

Direct sunlight  
Outdoors

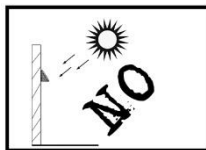

Direct sunlight  
thru window

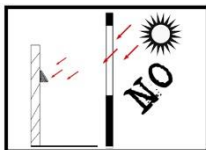

Indirect sunlight  
thru window

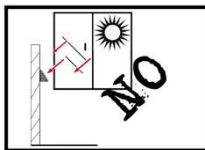

Too close to  
light fixtures

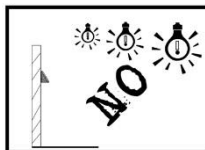

### 3. Installation Steps

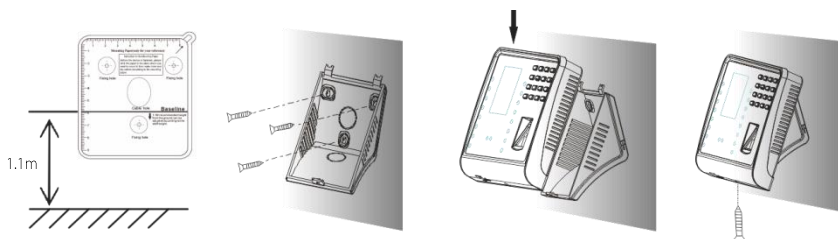

- 1) Post the installation template on the wall and drill. The distance from baseline to the ground is 1.1m by recommendation (for height in 1.55m to 1.85m). If the distance is 1.2m, the suitable height is beyond 1.65m.
- 2) Fix the plate with the screws on the hole drilled on the wall.
- 3) Up down fix the device into the plate.
- 4) Fix the bottom screw.

### 4. Lock Connection

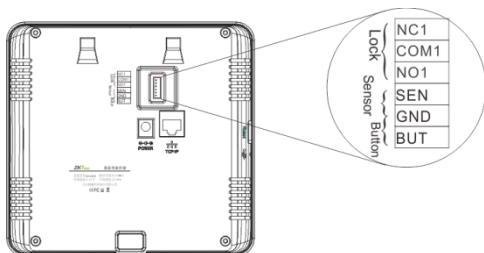

PIN	Name	Description
1	NC1	Normal Close
2	COM1	COMM
3	NO1	Normal Open
4	SEN	Sensor
5	GND	Ground
6	BUT	Button

The device and the Electrical Lock should be powered by independent power supply. It is recommended to use professional access control power supply as the Electrical Lock power supply, and select different output according to the actual situation of the Electrical Lock.

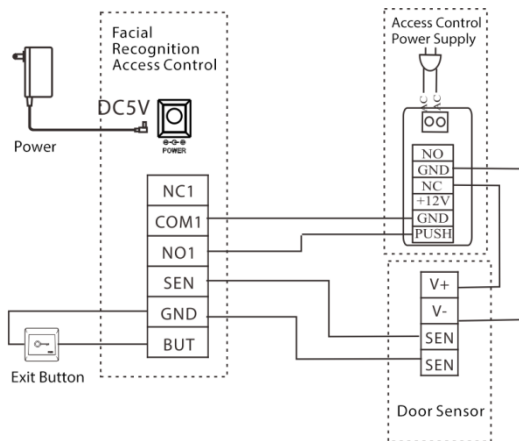

## 5. Notifications

### 1) Recommended Standing Position

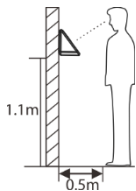

For users 5-6 feet tall (1.55m-1.85m), we recommend users stand about 2 feet (0.5m) from the device. When viewing your image on the device, step away if your image appears too bright, and step closer if your image appears too dark.

#### a. Recommended Method

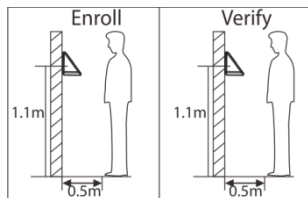

Recommended using methods (shown as left figures): During enrollment and verification, the installation position of device must remain the same. If need to move the device, keep the same installation height, or else, the recognition function will be poor.

## b. Not Recommended Methods

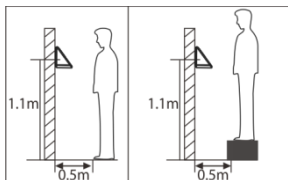

Too high

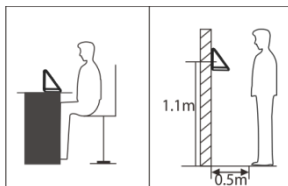

Too low

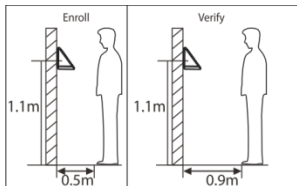

Too far

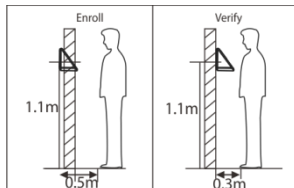

Too close

**Note:** During enrollment and verification, try to have a relaxed face expression and stand upright.

## 2) Enrolling Expressions

a. Please adjust your eyes into the green box by moving forward or backward while enrolling.



b. Please adjust your face into the green box to make it in the screen center.

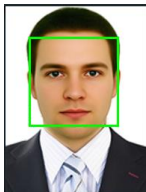

Note: Not all the devices have the function with ★.

## 6. Quick Flows

Department Setting ★ → Shift Setting ★ → Enroll Administrator and Users → Punch/Verify → View Records

Note: For products without function ★, please start from Enroll Administrator and Users.

### 1) Department Setting★ (Main Menu → Department Management → Add Dept. →Dept. Name)

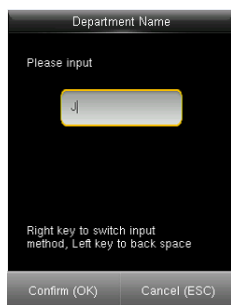

Enter the department name using the T9 input method. (For detailed operations, see T9 Input). Press [M/OK] key to save.

### 2) Shift Set★ (Not required if you use the Default Rule)

#### a) Attendance Rule Setting(Main Menu → Shift Set → Attendance Rule)

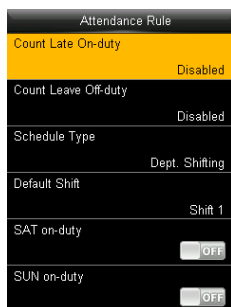

All attendance statistics are collected based on attendance rules. Attendance rules regarding how to calculate late arrival and early leave and how to arrange schedules need to be set first. Once set, they should not be modified from time to time.

**Schedule Type:** Department-based scheduling and individual-based scheduling are supported. If a company uses one timetable, only one department needs to be set and department-based scheduling is recommended. If departments have their respective timetables, department-based scheduling is recommended. If employees may take different shifts, individual-based scheduling is recommended.

#### b) Shift Setting(Main Menu → Shift Set → Shift Set)

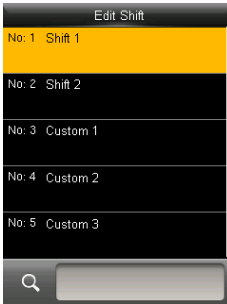

The device supports a maximum of 24 shifts including two default shifts (shift 1 and shift 2). All shifts can be edited and a single shift includes three time ranges at most.

### 3) Enroll Administrator (Main Menu → User Management → New User)

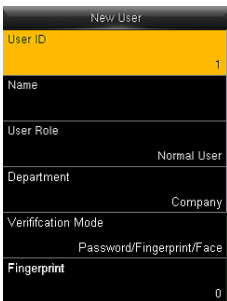

- User ID:** Enroll user ID, supports 1-9 digit of numbers.
- Name:** Enroll name, supports 1-12 digit of any characters.
- Use Role:** Select the user role (Normal User or Super Admin).
- Department:** Select department.
- Fingerprint:** Enroll a fingerprint or several fingerprints.
- Face:** Enroll face according to the prompts of screen and voice.
- Password:** Enroll the password, supports 1-9 digit of numbers.
- User Photo:** Enroll the user photo which will be displayed after verifying.
- Access Control Role:** Set the Access Control parameters of a user.

### There are explanations about Access Control Setting (Main Menu → Access Control):

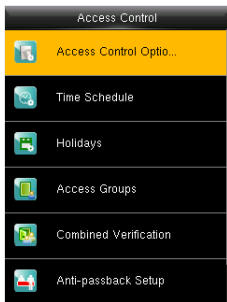

- Access Control Options:** Including Door Lock Delay, Door Sensor Delay, Door Sensor Type, Door Alarm Delay, Retry Times to Alarm, NC / NO Time Period etc.
- Time Schedule:** Schedule Doors' opening time, 50 time zones are available to define.
- Holidays:** Set special time zones for holidays.
- Access Groups:** Set to manage employees in groups.
- Combined Verification:** Make various groups into different access to achieve multi-verification.
- Anti-passback Setup:** Set Anti-passback direction and device status.
- Duress Options:** Set duress function options.

## 7. Quick Flows View Attendance Records

After verified successfully, users' attendance records will be saved in the device. You can view the attendance record and abnormal record using shortcut key on the initial interface or Attendance

Search function in the main menu. You can also download the attendance data and view it on computer.

### a. View records in the device using shortcut key

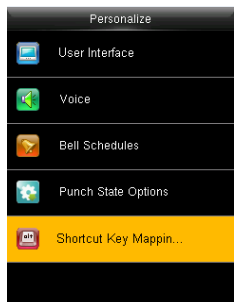

Press ▼ key to select Shortcut Key Mappings and press [M/OK] to enter.

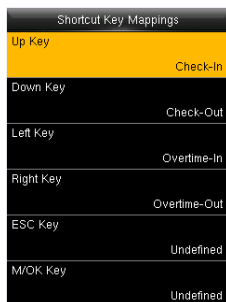

Press▲/▼key to select one key and press [M/OK] to enter for defining.

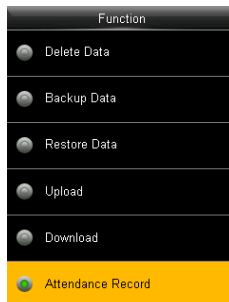

Press▲/▼key to select Attendance Record and press [M/OK] to set.

Press Shortcut Key on the initial interface, or press [M/OK] to enter the Main Menu, and then select Attendance Search → Attendance Records

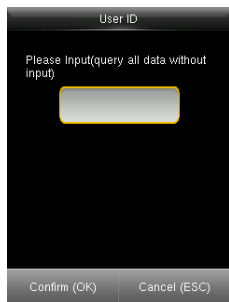

Input User ID to be searched, query all data without input. Press [M/OK] to continue.

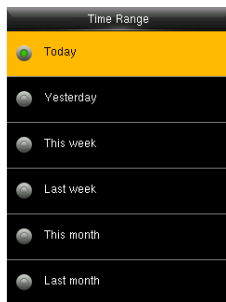

Press ▼ key to select Time Range and press [M/OK] to enter.

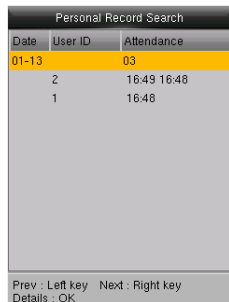

Press ▼ key to select one date and press [M/OK] to view detail.

### b. View records on computer (Main Menu → USB Manager → Download → Attendance Data)

Insert the USB disk correctly, download the attendance data to the disk, then upload that from the disk to your computer. The downloaded data is named "1\_StandardReport.xls", you can open to view it.



## 8. T9 Input

T9 input (intelligent input) is quick and high efficient. The device support T9 English and symbol input. By using T9 input, names, user roles, work codes, SMS content and some symbols can be input (For example, input Jack as below figures shown).

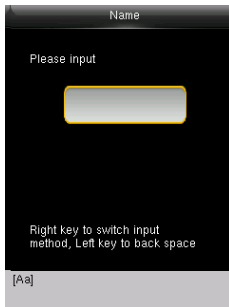

Press ► key to switch input methods: mixed case, upper case, lower Case, number and symbol.

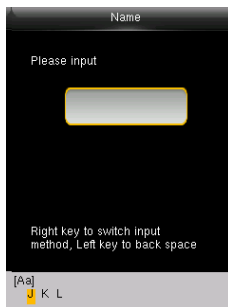

Press ► key to select mixed case [Aa], press numeric key 5 once to get letter J.

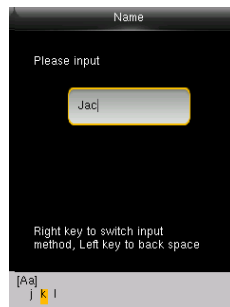

Press numeric key 2 once to get letter a. Again, press numeric key 2 three times to get letter c. Press numeric key 5 twice to get letter k.

## 9. Communication Settings

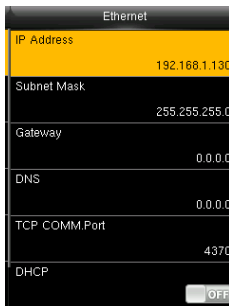

**IP Address:** The IP address is 192.168.1.201 by default and can be changed as required.

**Subnet Mask:** The subnet mask is 255.255.255.0 by default and can be changed as required.

**Gateway:** The gateway is 0.0.0.0 by default and can be changed as required.

**DNS:** The DNS is 0.0.0.0 by default and can be changed as required.

**TCP COMM. Port:** It is 4370 by default and can be changed as required.

**DHCP:** ON or OFF. When set as ON, the device will automatically obtain an IP address.

## 10. Backup Data

Backup the business data or system data to the device or USB disk.

To avoid deleting data by misoperation, you can backup data to local or USB disk at any time.



Press ▲/▼ key to select Backup to Device or USB Disk and press [M/OK] to enter.

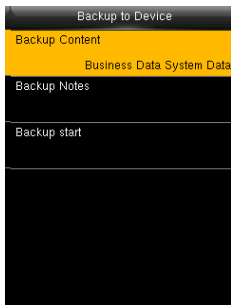

Press ▲/▼ key to select Backup Content and press [M/OK] to enter.

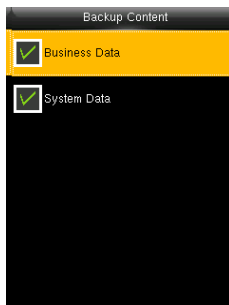

Press [M/OK] to select backup content.

## 11. Problems & Solutions

1. The face is not recognized by the device while verification.

### Solutions:

- Check out if the expressions or standing postures and distance is same in enrolling and verifying.
  - Check out if the sunlight is direct to the device or if the device is near to the windows.
2. Users do not wear glasses in enrolling and wear glasses in verifying.

**Solutions:** You can enroll face wearing glasses for first catching face, and then take off glasses for the left catching.

3. The device makes a misjudgment while verification.

**Solutions:** There is a certain probability of misjudgment, you can re-enroll the face.

ZK Building, Wuhe Road,  
Gangtou, Bantian, Buji Town,  
Longgang District, Shenzhen  
China 518129  
Tel: +86 755-89602345  
Fax: +86 755-89602394

