

NETZSCH

Proven Excellence.



DSC 204 HP *Phoenix*[®]

High-Pressure Differential Scanning Calorimetry up to 15 MPa
Method, Technique and Applications

Analyzing & Testing

DSC 204 HP *Phoenix*®

The ability to apply pressure improves the capabilities of Differential Scanning Calorimetry (DSC).

High-Pressure DSC

Differential Scanning Calorimetry (DSC) allows not only for the determination of phase transformation temperatures but also for the quantification of transformation enthalpies. In the low-temperature range, samples are generally analyzed in aluminum crucibles with a pierced lid under atmospheric pressure in a constant purge gas flow. With a type of modified DSC – where the measuring cell is installed in an autoclave (a “pressure DSC”) – it becomes possible to carry out measurements under pressures ranging from 5 kPa to 15 MPa (high-pressure DSC).

Measurements in Inert or Reactive Gas Atmospheres

High-pressure DSC measurements can be carried out in inert or reactive gas atmospheres. If an inert gas is used, the pressure dependency can be studied when sample transformation (usually a caloric effect) is also accompanied by a volume change. This allows for the investigation of dehydration and decomposition reactions with gas release by means of pressure DSC.

When using a reactive gas, the gas becomes one of the reactants and the pressure therefore is a measure of its concentration. With this method, aging tests can be performed on organics (such as oils, fats, waxes, greases, etc.) and polymers.

Calibration

Within the accessible pressure range, melting is only slightly pressure-dependent. It is therefore possible to employ metallic reference materials commonly used for DSC measurements for temperature and enthalpy calibration.

Application Range of HP-DSC

- Determination of vapor pressure and evaporation heat (ASTM E1782)
- Separation of reactions with overlapped evaporation
- Measurement of adsorption and desorption, e.g., on metallic compounds
- Oxidation stability of oils, fats, and lubricants (ASTM E1858, ASTM D6186, ASTM E2009, ASTM D5483)
- Curing of thermosets, e.g., phenolic resins
- Vulcanization of elastomers
- Hydration of unsaturated fatty acids
- Susceptibility of materials to melting point depression in reactive gas atmosphere
- DSC measurements under ambient pressure can, of course, also be conducted with the DSC 204 HP *Phoenix*®, even under reduced pressure

THERMOKINETIC
EVALUATION

MEASUREMENTS BETWEEN
-150°C AND 600°C

DISPLAY OF PRESSURE SIGNAL

ACCURATE PRESSURE
CONTROL OVER THE
ENTIRE PRESSURE RANGE

OXIDIZING, REDUCING
AND INERT ATMOSPHERE

ACCURATE GAS FLOW
CONTROL UP TO
500 ML/MIN

VARIETY OF CRUCIBLES

MEASUREMENTS FROM
VACUUM TO 15 MPA

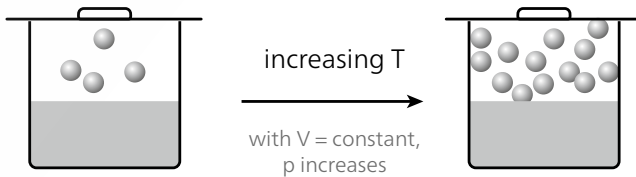
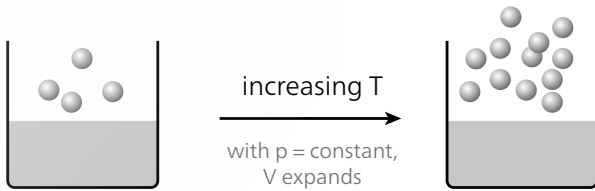

Trendsetting Technology

High-Pressure DSC Measurements Even at Subambient Temperatures

In contrast to the setup of a regular DSC, the measuring cell of a high-pressure DSC (HP-DSC) is surrounded by an autoclave which is supported by pressure and gas flow control systems. Pressure and purge gas flow are adjusted via a separate control board (see also next page). With the help of liquid nitrogen cooling, it is even possible to achieve temperature programs in the subambient range. The heating and cooling rates achieved (0.01 K/min to 100 K/min and to 50 K/min, respectively) as well as the maximum and minimum temperatures are significantly influenced by the atmosphere and pressure used (e.g., in a helium atmosphere, it is possible to cool down to -70°C at 10 MPa).

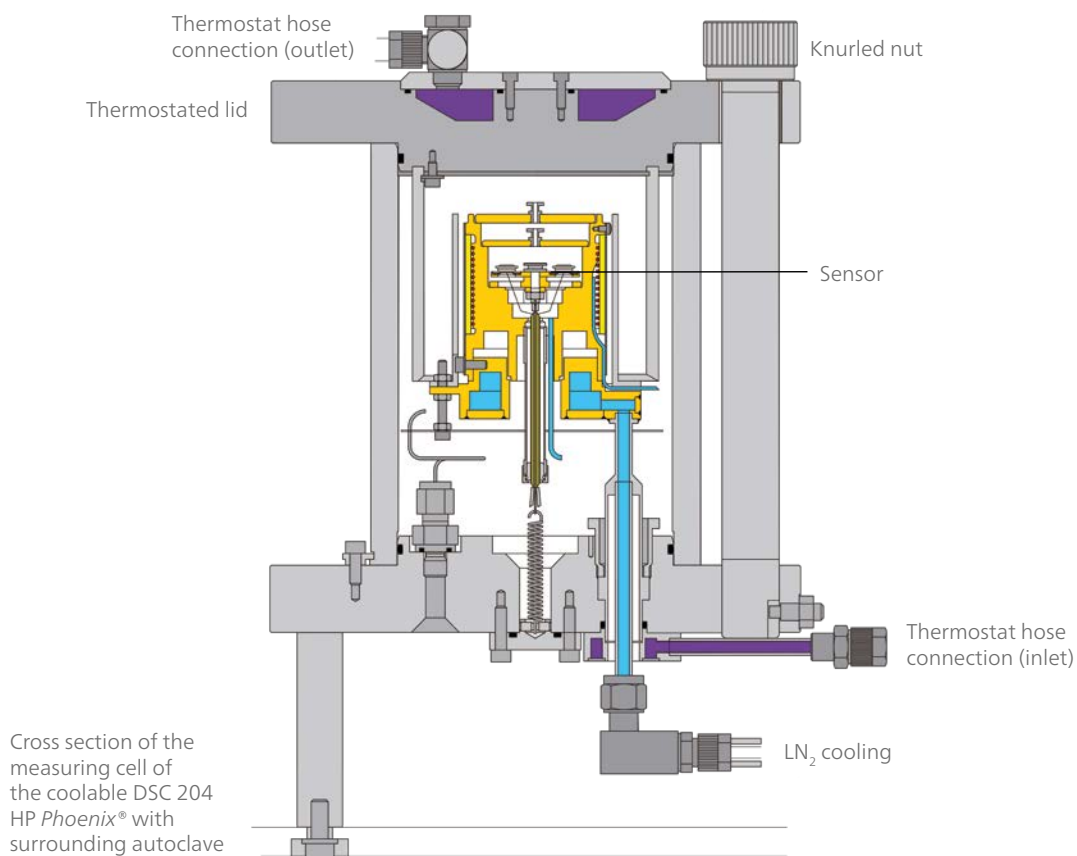

In some reactions, the atmosphere not only serves for the generation of pressure but is also a reaction partner in the expected solid-gas reaction. Regulation of pressure and gas flow must be particularly precise.

Precise Pressure and Gas Flow Control

Measurements in different gas atmospheres such as O₂, N₂, Ar, He, H₂, CO₂ and CH₄ are no problem in the robust measuring cell. The sample atmosphere can be either static or dynamic. The optional electronic pressure control device along with the ability to precisely regulate the purge gas flow are the main features allowing for outstanding accuracy and reproducibility of the measurements. The system also allows for measurements under adjustable reduced pressure. Of course, the DSC 204 HP *Phoenix*[®] meets all safety regulations which are required for measurements under pressure

Pressure Control Systems for Operation under:	Application
Static gas atmosphere	Constant (defined) gas pressure up to 15 MPa during heating
Dynamic gas atmosphere	<ul style="list-style-type: none"> ■ Constant (defined) gas pressure during heating and constant (defined) gas flow at the sample ■ Measurement in static or dynamic gas mixture ■ Use of an inert gas (e.g., Ar) to establish a defined gas pressure and measurement under a dynamic reaction gas atmosphere (e.g., O₂ at 100 ml/min)

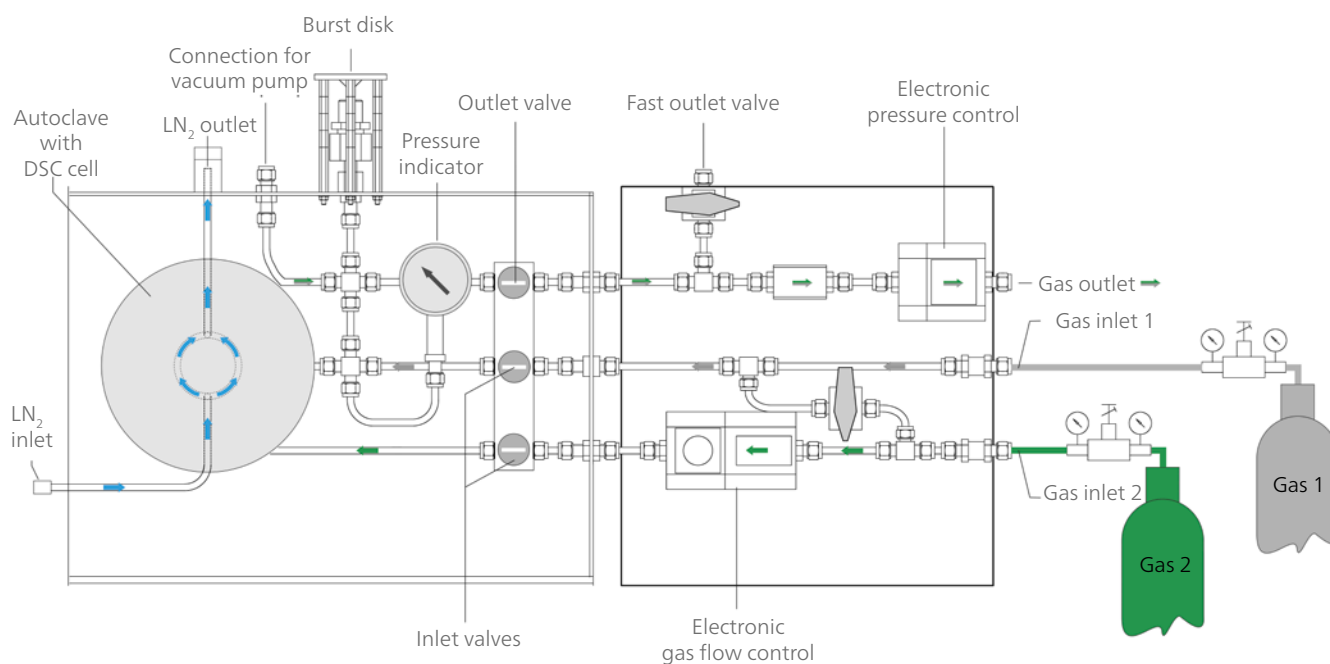

Optional pressure control for accurate, highly precise regulation of pressure and gas flow

Versatile Applications

Synthetic Oil – Increasing Oxygen Pressure Resulting in Oxidation at Lower Temperatures

This graph shows the oxidation behavior of a stabilized synthetic oil (sample mass of 3.0 mg \pm 0.1 mg) in aluminum pans at 2 K/min in oxygen (100 ml/min) under defined pressures. As oxygen pressure increases, oxidation begins at lower temperatures (lower extrapolated onset temperature).

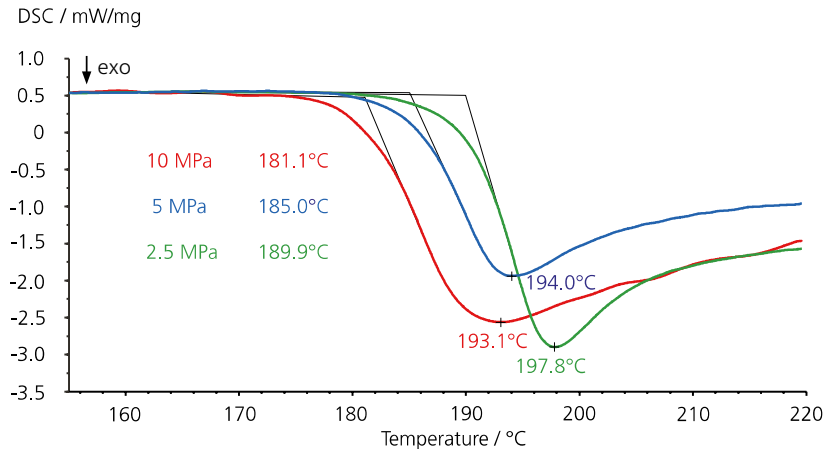

Polycondensation – Curing Behavior of Phenolic Resins

This graph shows the partial area evaluation of the curing effect of two phenolic resin lots (A, B) under a practical pressure of 9 MPa in an inert gas atmosphere at 10 K/min (sample mass 10.5 mg).

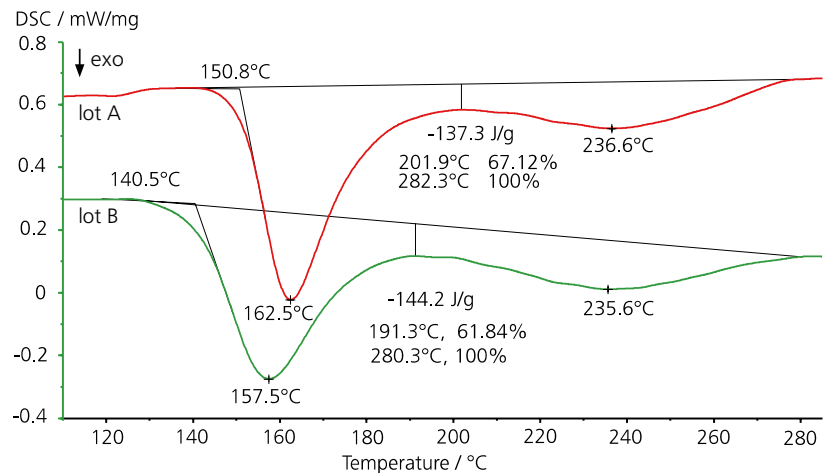

Hydrogenation of a Metal Catalyst

Here shown is the exothermal hydrogenation of a metal catalyst under 7 MPa in a pure hydrogen atmosphere (sample mass 6.09 mg; heating rate 10 K/min).

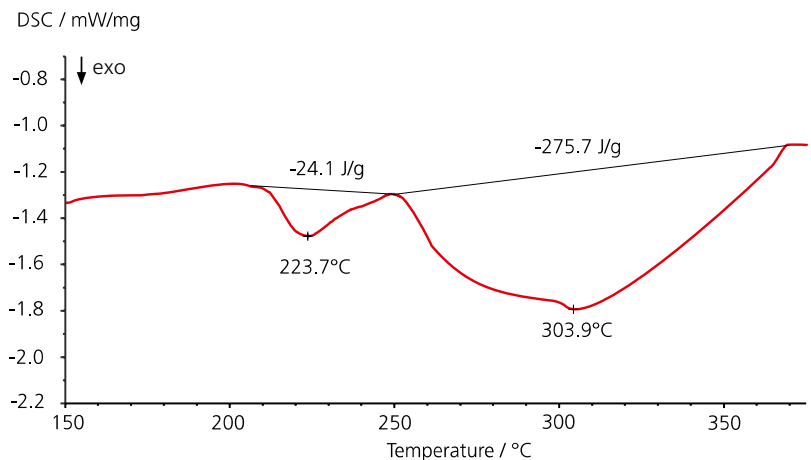

Precision of the Pressure Control, Dehydration of Iron Oxide Hydroxide

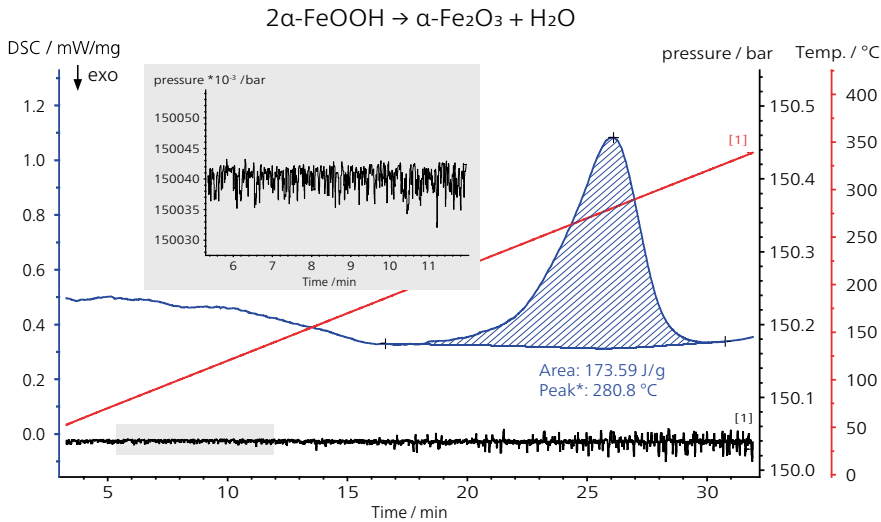

Just like decomposition, dehydration reactions are significantly influenced by the pressure applied. This example shows a measurement on a nanocrystalline goethite at a heating rate of 10 K/min. With increasing pressure, the release of gaseous reaction products is shifted to higher temperatures: from 251°C at ambient pressure (not shown here) to 281°C at 150 bar. The pressure variations detected during the dynamic heating segment do not exceed 150 bar \pm 0.01 bar (a hundred times smaller than prescribed by ASTM D6186). Influences of the pressure on the DSC signal (e.g., noise) are therefore negligible.

Technical Specifications

DSC 204 HP Phoenix®

Temperature range	-150°C to 600°C, depending on gas pressure and type
Heating rate	0.01 K/min to 100 K/min, depending on gas pressure and type
Cooling device	Liquid nitrogen; temperature range depends on gas pressure and type
Pressure range	Vacuum to 150 bar (15 MPa, \approx 2175 psi)
Pressure measurement	<ul style="list-style-type: none"> ■ Precision: \pm 0.15 bar ■ Accuracy: \pm 0.75 bar
Atmosphere	Static and/or dynamic, inert (N_2 , noble gases), reducing (H_2)*, oxidizing (O_2 , air, CO_2 up to 57 bar); other gases on demand
Gas flow	Up to 500 ml/min, accuracy \pm 1 ml/min
Operation modes	Various static and dynamic gas atmospheres and pressure conditions

* The user is responsible for reliable operation under hydrogen in accordance with relevant safety regulations.



The NETZSCH Group is an owner-managed, international technology company with headquarters in Germany. The Business Units Analyzing & Testing, Grinding & Dispersing and Pumps & Systems represent customized solutions at the highest level. More than 3,800 employees in 36 countries and a worldwide sales and service network ensure customer proximity and competent service.

Our performance standards are high. We promise our customers Proven Excellence – exceptional performance in everything we do, proven time and again since 1873.

When it comes to Thermal Analysis, Calorimetry (adiabatic & reaction), the determination of Thermophysical Properties, Rheology and Fire Testing, NETZSCH has it covered. Our 50 years of applications experience, broad state-of-the-art product line and comprehensive service offerings ensure that our solutions will not only meet your every requirement but also exceed your every expectation.

Proven Excellence.■

NETZSCH-Gerätebau GmbH
Wittelsbacherstraße 42
95100 Selb
Germany
Tel.: +49 9287 881-0
Fax: +49 9287 881 505
at@netsch.com

NETZSCH[®]

www.netsch.com