

# SmartLab SE

Automated Multipurpose X-ray Diffractometer

X-ray diffraction (XRD) analysis with  
advanced Guidance expert system software



**Rigaku**

Leading With Innovation

# Highly versatile multipurpose XRD system with built-in intelligent guidance



## Modern X-ray diffractometer

Modern X-ray diffractometers are expected to support multiple applications; e.g., powder diffraction, small angle X-ray scattering, residual stress and mapping, to name a few. However, with the increase in complexity and sophistication that accompanies a multipurpose instrument comes the risk of a decrease in usability. How do you know for certain that you or your fellow researcher is selecting the best optics for each application? When switching between complex configurations, how can you be absolutely certain that your instrument remains aligned and that the data that you measure is of the utmost quality?

SmartLab SE answers these questions in three ways. First, the instrument recognizes the specific optic components that are currently mounted on the diffractometer and checks the configuration against the type of measurement that you have selected. If the current configuration is not the best one for your intended measurement, the software suggests how you should change the hardware configuration for the type of application selected.

Second, after the proper hardware components have been added to the instrument, the instrument performs an automatic alignment—a unique feature of Rigaku and the only true way to know that your instrument is ready to collect the high quality data that your research demands.

And third, new SmartLab Studio II software provides an integrated modular X-ray diffraction suite for the innovative SmartLab SE system. Covering the full spectrum of operations required for X-ray diffraction analysis, including measurement, analysis, data display and reporting, SmartLab Studio II software was engineered from the ground up with ease-of-use in mind. The novel Guidance “expert system” ensures that even novice users are able to quickly master advanced measurements.

## Guiding the entire flow of measurement to analysis

Guidance is an expert system, within SmartLab Studio II, that suggests the optimal hardware configuration and settings for specific application measurements. The software will determine which optics are most appropriate for a given application, determine the instrument settings and execute the measurement, offering a completely automated measurement sequence. Since the SmartLab has built-in component recognition, Guidance will not only tell you how you should configure the SmartLab for a given measurement, it will also warn you if you have not configured it properly. Expert advice coupled with hardware that will confirm the correct configuration is the foundation of the SmartLab system.

## Supporting a variety of applications

A variety of optics and attachments are available to meet users’s measurement purposes and sample shapes.

## Easy and quick switch between geometries

Coupling the CBO (Cross Beam Optics) optical unit with fully automated optical and sample alignments allows simple and quick switching of geometries.

## Diverse attachments

Automatic sample change, sample spinning and orientation, temperature or humidity control, etc. can be achieved using Rigaku’s extensive selection of attachments.

## State-of-the-art detectors for high-speed and 2D measurements

SmartLab SE offers two state-of-the art detectors: D/teX Ultra 250 high-speed 1D silicon strip X-ray detector as an entry model, and HyPix-400 2D semiconductor hybrid pixel array detector as a high-end model. The HyPix-400 functions not only in 2D mode, but also in 0/1D mode, which broadens the range of available applications.



## From powder measurements to 2D measurements

Depending on users' needs, the system configurations are also selectable from an entry model for powder measurements to a high-end model supporting micro-area, *in-situ* X-ray measurements.

### Standard optical configuration

Bragg-Brentano focusing optics

- Powder measurements
- Qualitative analysis
- Crystallite size
- Crystallinity

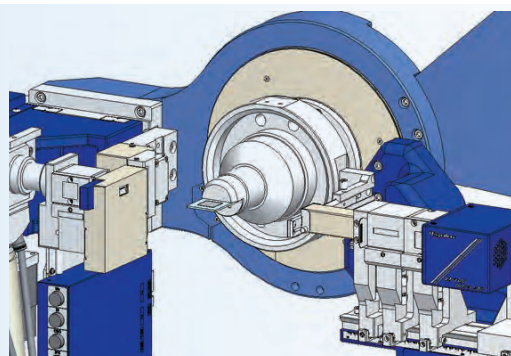

### For SAXS or powder measurements

#### Cross Beam Optical (CBO) technology

### Optics with CBO unit

Focusing method ⇔ Parallel beam method (CBO)

- SAXS measurement
- Thin film measurement

Focusing method ⇔ Convergent beam method (CBO-E)

- Powder transmission measurement

Focusing method ⇔ Divergent beam method (CBO- $\alpha$ )

- High peak-to-background ratio powder measurement

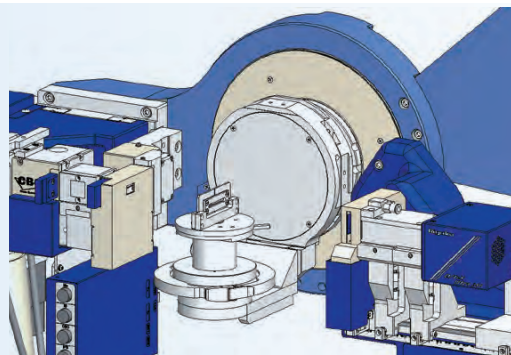

### For micro-area or *in-situ* measurements

#### Two-dimensional detector

### Optics with HyPix-400

Optics with HyPix-400 for 2D measurements

- Micro area measurement
- *In-situ* measurement
- Orientation measurement

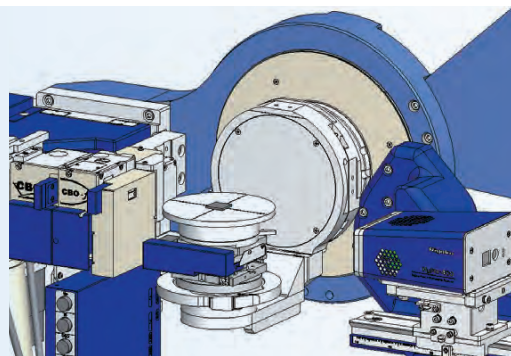

# Features of SmartLab SE

## State-of-the-art detectors for high-speed measurements

### High-resolution, ultrafast 1D X-ray detector D/teX Ultra250 (0/1D)

The D/teX Ultra250 one-dimensional detector supports high-speed Bragg-Brentano focusing measurements and is capable of acquiring wide-angle powder diffraction profiles in just a few minutes. Its high-energy resolution, the distinguishing feature of semiconductor detectors, helps reduce the background of measurements. The D/teX Ultra250 functions as a 1D detector to detect even trace components due to an effect of the integrated intensity, and also functions as a 0D detector like a scintillation counter by simply switching modes in software.

### Hybrid pixel array multi-dimensional detector HyPix-400 (0D /1D/2D)

The HyPix-400 hybrid pixel array 2D detector can also be used with SmartLab SE. In addition to the 0/1D mode that is supported by D/teX Ultra250, the HyPix-400 functions as a 2D detector, which acquires 2D diffraction patterns to evaluate crystal orientation and wide-range reciprocal space mapping in a short time.



D/teX Ultra250



HyPix-400

## Cross Beam Optics : CBO (Patented)

CBO is an optical selection unit that enables switching between two geometries by simply changing slits. In SmartLab SE, three types of CBO units are selectable according to users' purposes: Bragg-Brentano focusing/parallel beam, Bragg-Brentano focusing/convergent beam, Bragg-Brentano focusing/divergent beam.

### Bragg-Brentano focusing method:

This method is used for general powder XRD measurements.

### Parallel beam method (CBO):

The beam is parallelized by a multilayer parabolic mirror. This method is used for SAXS, thin films, rough surface sample measurements, etc.

### Convergent beam method (CBO-E):

An elliptic multilayer mirror converges the beam on the detection surface, providing high-angle resolution data in transmission geometry.

### Divergent beam method (CBO- $\alpha$ ):

The beam is monochromatized to  $K\alpha$  -rays with a plane multilayer mirror, which delivers higher P/B ratio at an equivalent intensity level compared to the Bragg-Brentano focusing method.

#### Bragg-Brentano focusing method

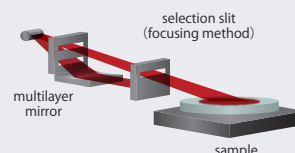

#### Parallel beam method

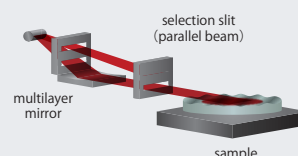

#### Convergent beam method

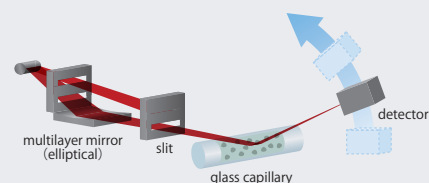

#### Divergent beam method

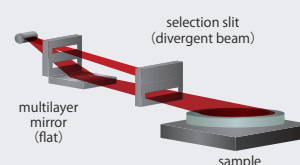

# Measurement and analysis suite SmartLab Studio II

SmartLab Studio II is a software package with a user-friendly GUI that integrates all optical alignments, measurements, and analyses. Users can choose the desired modules from various plugins, such as “Measurement”, “Powder XRD analysis”, “Pole figure and ODF analysis”, and “Stress analysis”, and operate them on a single platform with an improved analysis environment and operability.

## Optics sensing and guidance function

Using an auto-sensing function for optical configuration, Rigaku’s original guidance instructs users to change geometries or optics with illustrations, allowing them to perform optical settings in a straightforward fashion.

In addition, recommended settings of optics, sample alignment, and measurement sequences are preset in the software to help inexperienced start XRD measurement without difficulty.

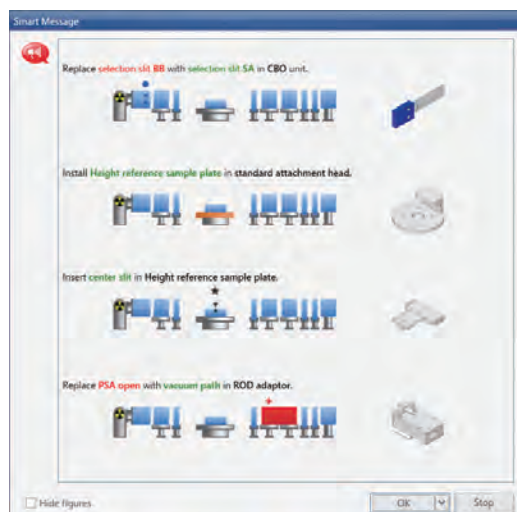

## Flow bar navigation

SmartLab Studio II contains a flow bar to guide users through the necessary steps from loading measurement data to analyzing and saving measurement data, so users can proceed with their analyses with a good understanding of each step.

## Integrated information management

The SmartLab Studio II employs an SQL database to manage and share material information, measurement data, and analysis results on a single network. The SQL database has outstanding search and backup functions, making it easy to handle even when there is an enormous amount of data.

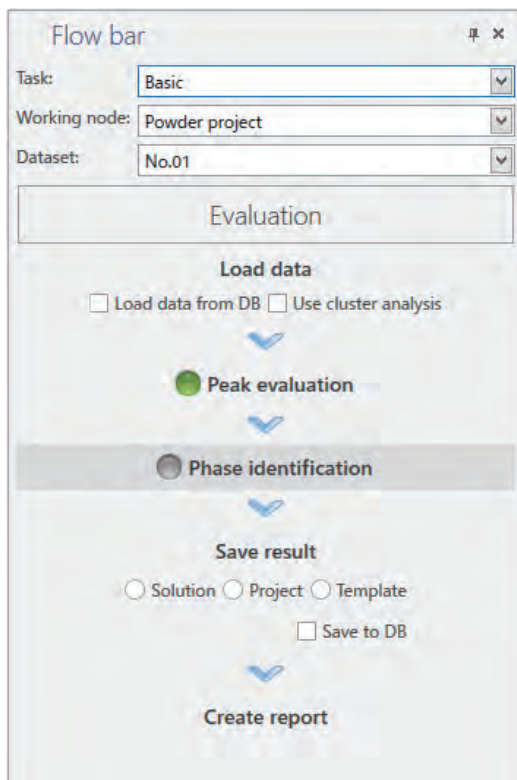

# SmartLab SE optical configurations for diverse applications

## Powder diffraction measurement in reflection/transmission mode

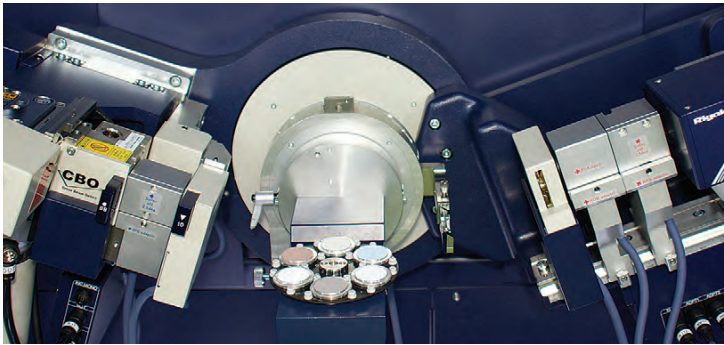

### Reflection mode optical configuration

- Bragg-Brentano focusing method
- Parallel beam method
- Divergent beam method

Users can easily switch geometry from the generally used reflection mode to transmission mode according to users' measurement purposes. The transmission method provides high-intensity and high-resolution data using a convergent beam.

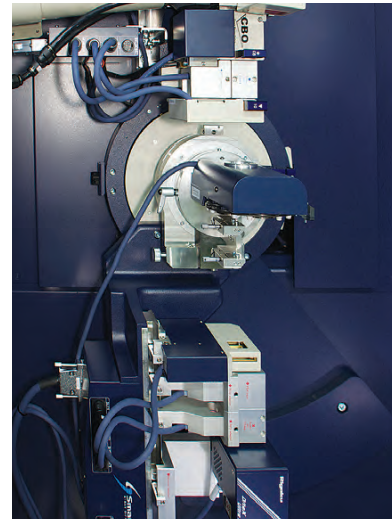

### Transmission mode optical configuration

- Convergent beam method
  - Parallel beam method
- (The above picture shows the vertical transmission geometry.)

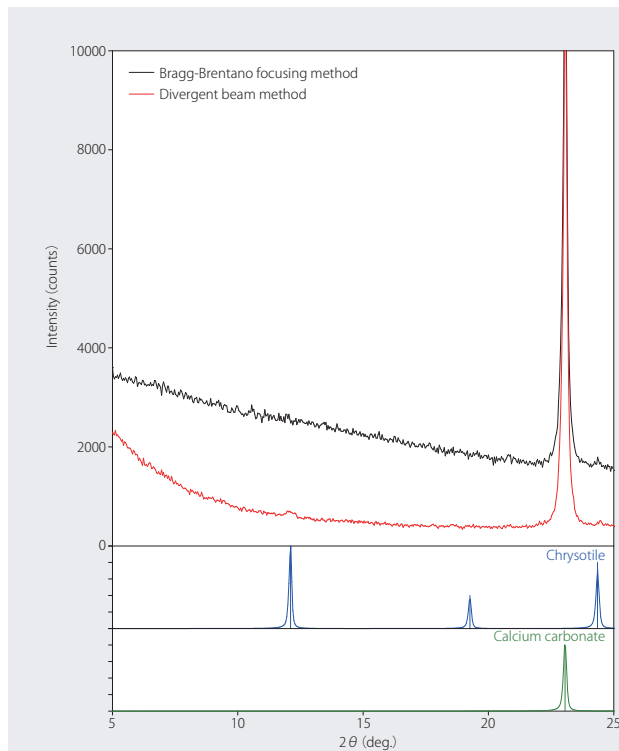

#### 0.1 mass% asbestos (chrysotile) in calcium carbonate

A divergent beam monochromatized by a flat multilayer mirror enables the acquisition of an X-ray diffraction pattern with higher P/B compared to the conventional Bragg-Brentano focusing method. Diffracted X-rays from very low concentration asbestos can be detected.

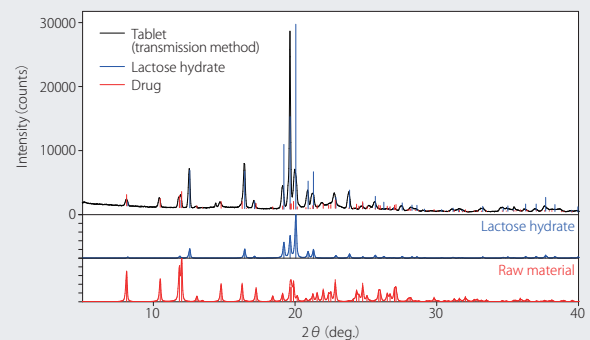
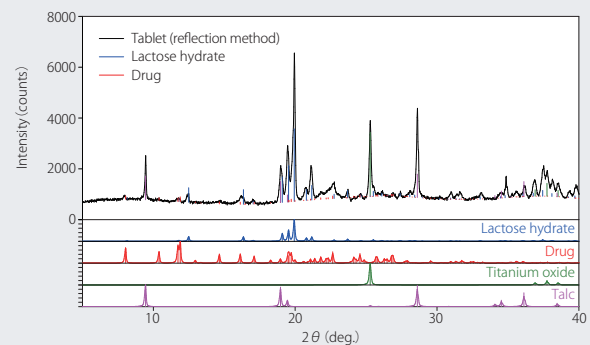

#### X-ray diffraction measurement of a pharmaceutical tablet by reflection method and transmission method

Pharmaceutical tablets are coated with excipients or coloring agents to reduce the bitterness of the drug ingredients, making it easier to take. Information concerning the tablet surface can be obtained by the reflection method, and information about the inside of the tablet can be obtained by the transmission method.

## Micro-area diffraction measurement

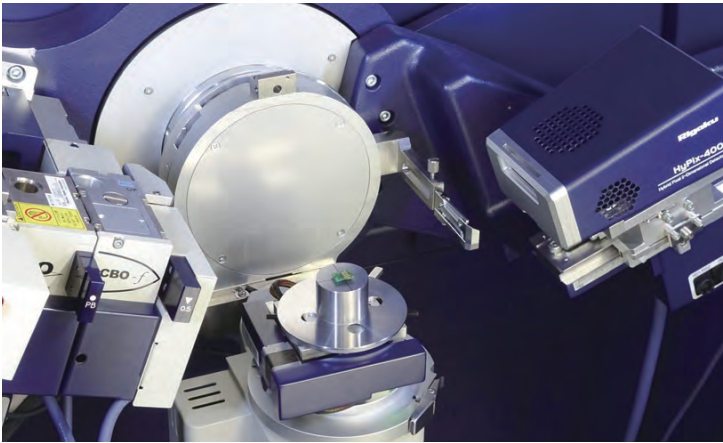

This configuration uses Rigaku's original optical unit CBO-f, which converges X-ray beam on the sample surface and thus eliminates the need to change the X-ray tube from line focus to point focus. In addition, D/teX Ultra250 or HyPix-400 can detect even a weak diffraction beam from a micro area in a short time.

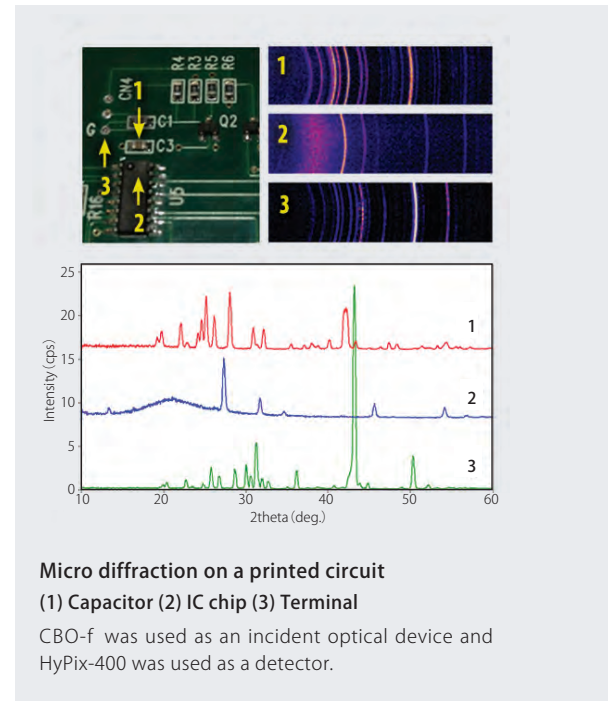

**Micro diffraction on a printed circuit**  
 (1) Capacitor (2) IC chip (3) Terminal

CBO-f was used as an incident optical device and HyPix-400 was used as a detector.

## Pole figure/residual stress measurement

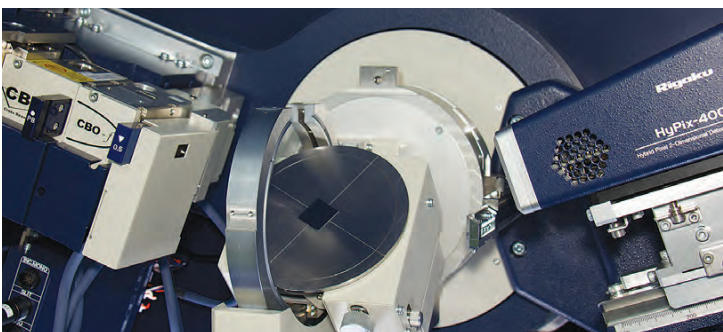

In pole figure measurements with a line source, using the Schulz slit reduces the intensity attenuation that is caused by the extension of the X-ray radiation field, which achieves an effect equivalent to using a point source.

The "Pole figure and ODF analysis " plugin enables performing crystal orientation analysis and creating a whole pole figure by recalculation. The parallel-slit analyzer (PSA) eliminates the peak shifts caused by displacement errors from residual stress measurements.

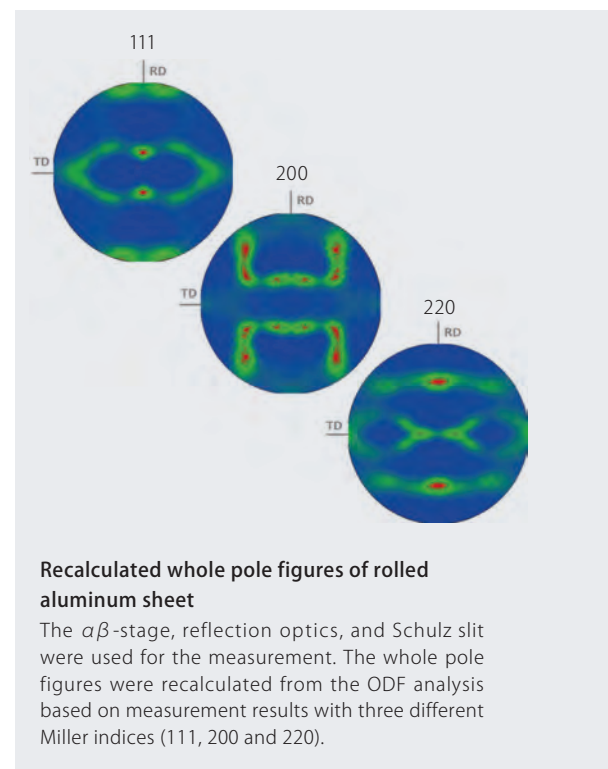

**Recalculated whole pole figures of rolled aluminum sheet**

The  $\alpha\beta$ -stage, reflection optics, and Schulz slit were used for the measurement. The whole pole figures were recalculated from the ODF analysis based on measurement results with three different Miller indices (111, 200 and 220).

## Small angle X-ray scattering measurement (SAXS)

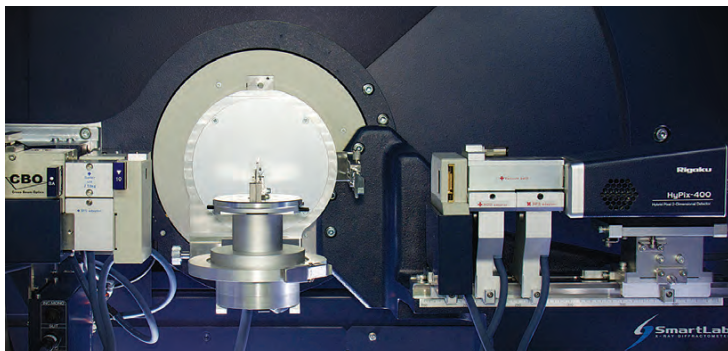

In the SAXS technique, measurement are performed in the  $2\theta$  region less than  $10^\circ$ , where distribution of particle-/pore-size less than 100 nm and long-period structure are evaluated. SAXS optics with 2 slits and parallel beam are available.

By using a vacuum path, air scattering can be reduced to obtain high-quality data.

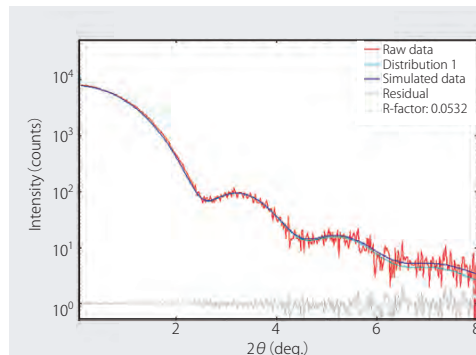

1D SAXS profile of gold particles diluted in toluene (2-slit optics)

## In-situ measurements

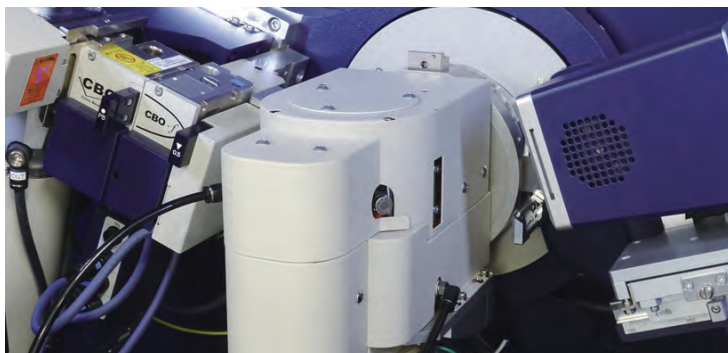

*In-situ* measurement enables observing changes in sample state with variations in temperature and humidity at the same time. SmartLab SE supports a variety of in-situ measurement attachments, such as for observing changes in the sample state with changes in humidity or temperature, and for observing changes in the sample state before and after a thermal reaction when combined with the DSC attachment. With the combination of an in-situ attachment and HyPix-400, real time measurements are achievable, allowing the identification of brief structural changes, as well as large grains and orientation.

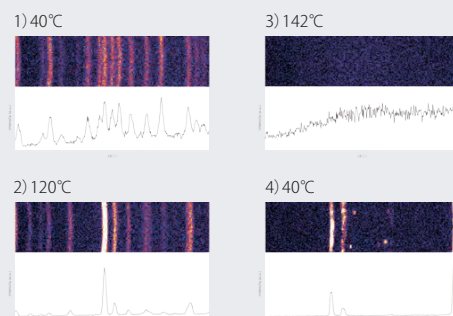
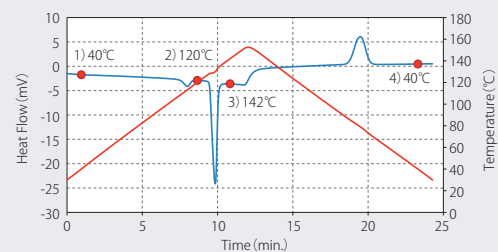

Phase transition/melting behavior of tolbutamide, a therapeutic agent for diabetes, with the change of temperature

Tolbutamide changes its crystal structure with the change of temperature. Combined with the two-dimensional detector HyPix-400, it enables to clearly confirm the crystal structure change before and after the endothermic reaction peak.



# Rigaku quality through superior engineering

## Mechanical & electrical engineering

Since its foundation in 1951, Rigaku has been offering leading-edge X-ray diffraction instruments using high precision mechanical engineering and original core technologies. Foremost among these are our high-precision goniometers and rotating anode type X-ray generators, the key components of our X-ray diffraction instruments, both designed and produced by Rigaku. SmartLab SE inherits the technology and knowledge fostered over more than half a century in the form of the HyPix-400 hybrid detector and a goniometer with the industry's highest level of accuracy.

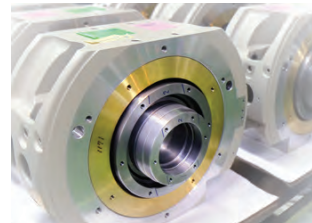

## Software engineering: Guidance

Intelligent software that determined which optical modules are best for an application, and performs automatic alignment, setup and measurement. Guidance "expert system" software inside of the SmartLab Studio II platform was engineered to deliver a completely automated measurement sequence.

### Measurement Flow

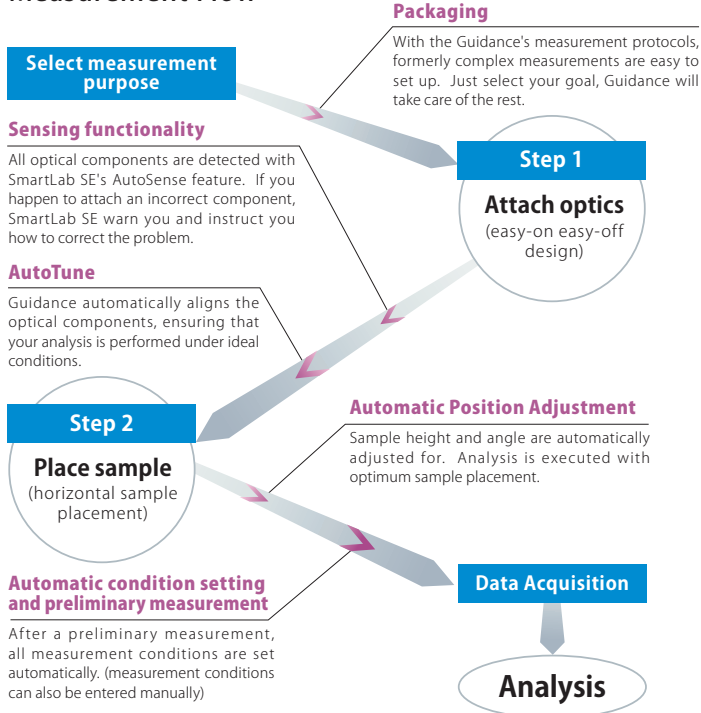

### Case Study:

Time saved using Guidance to gather Rietveld measurement data

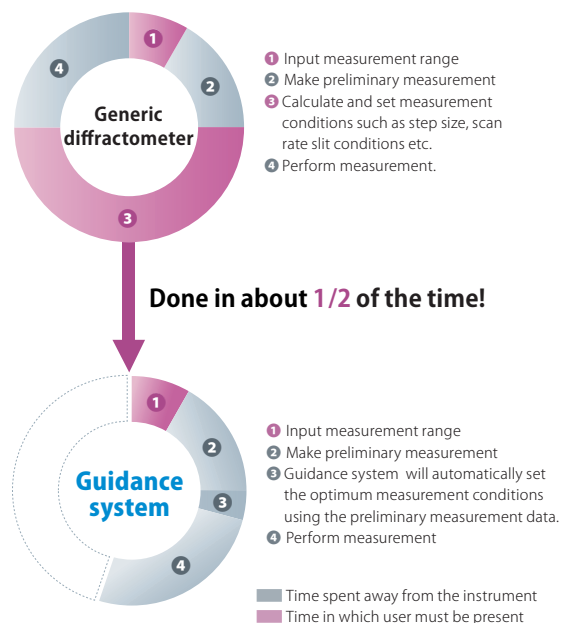

## Quality assurance

SmartLab SE, with its high reproducibility, precision goniometer and automatic optical alignment function, guarantees no zero-point shift in measurements even after changing X-ray tubes.

Reproducibility remains high after changing optical devices; direct beam angle ( $2\theta = 0^\circ$ ) after removing and replacing all incident and receiving optics is guaranteed within the error range of  $0 \pm 0.005^\circ$ .

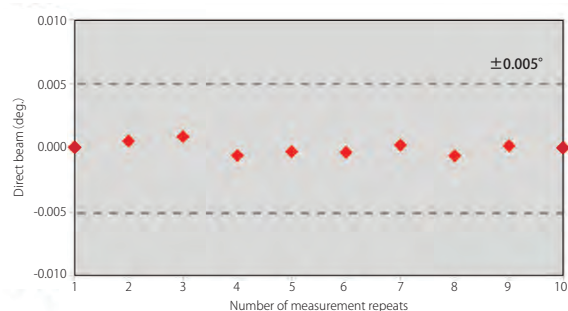

# Optional attachments and sample holders

## ASC-6 (auto sample changer)

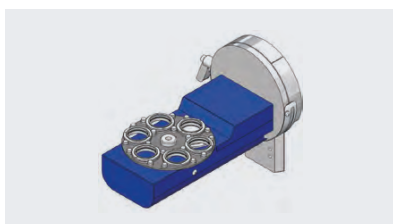

Number of samples	Max. 6 samples
Sample rotation speed	Max. 120 rpm, rotation speed can be set via computer
Sample size	Max. 24 mm diameter

## ASC-10 (auto sample changer)

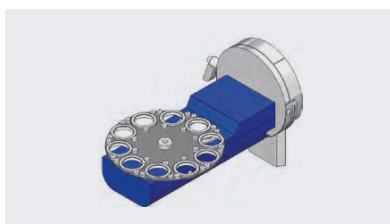

Number of samples	Max. 10 samples
Sample rotation speed	Max. 120 rpm, rotation speed can be set via computer
Sample size	Max. 24 mm diameter

## Capillary spin attachment head

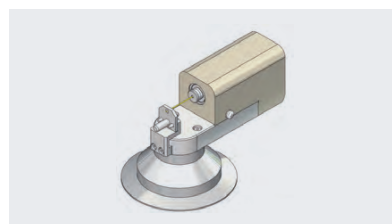

Capillary sizes	0.3, 0.5, 0.7 and 1.0 mm
Sample rotation speed	1 - 120 rpm

## $\alpha\beta$ sample stage

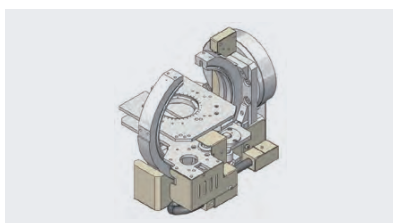

Range ( $\alpha$ axis)	-5 to 95°
Minimum step size ( $\alpha$ axis)	0.002°
Range ( $\beta$ axis)	±360°
Minimum step size ( $\beta$ axis)	0.01°
Spinning speed ( $\beta$ axis)	1 - 30 rpm
Oscillation ( $\gamma$ axis)	±5 mm

## XY-20 mm attachment head

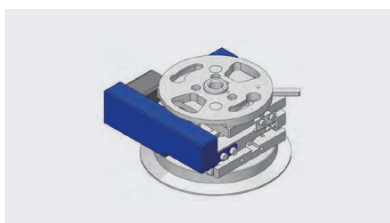

Movable range (X, Y axis)	±10 mm
Minimum step size	0.0005 mm

## Battery cell attachment head

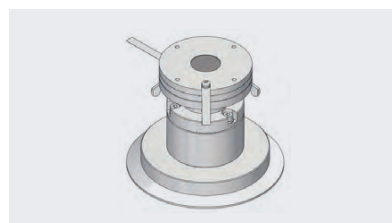

Electrode material	Stainless steel
Insulator	Teflon
Number of poles	2 (electrode & counter electrode)
Window for X-ray	Current collector (aluminium), $\phi$ 20mm
Meas. range	10 - 158° ( $2\theta$ )

## DSC attachment

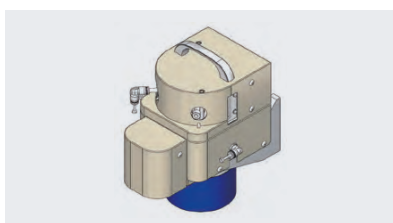

DSC	Heat flow type
Measurement temperature range	Ambient to 350°C (-40°C~, optional)
Measurement atmosphere	Air, inert gas (Humid atmosphere measurement form ambient to 60°C, 5%RH to 95%RH optionally available by connecting to a humidity generator HUM)
Measurement angle range	5 - 55° ( $2\theta$ )

## HTK 1200N\*1

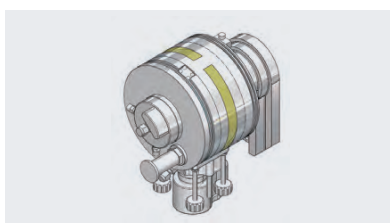

Measurement temperature range	Ambient to 1200°C
Measurement atmosphere	Vacuum, air, inert gas, etc.*2
Measurement angle range	0 - 160° ( $2\theta$ )
Capillary model also available	

## TTK 600\*1

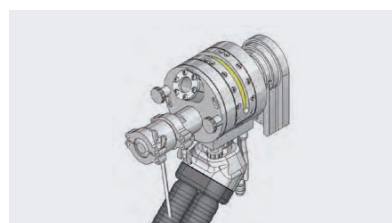

Measurement temperature range	-20°C to 600°C (Cooling with compressed air) -190°C to 600°C (Cooling with liquid N <sub>2</sub> )
Measurement atmosphere	Vacuum, air, inert gas
Measurement angle range	0 - 160° ( $2\theta$ )

\*1 Products of Anton Paar. Many other Anton Paar attachments are available for SmartLab SE.  
\*2 Consult Rigaku when the use of a special gas is wanted.

## Air-sensitive sample holder

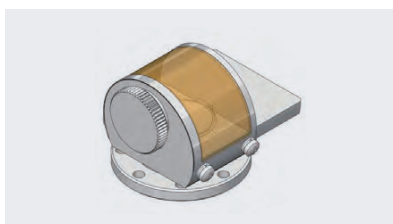

Sample holder which can adjust the atmosphere.

## Si zero-background sample holder

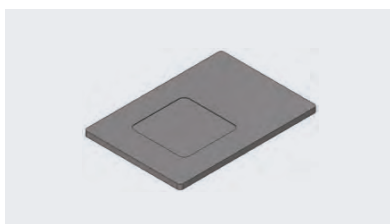

Single crystal Si sample holder cut out in a special orientation which enables low background measurement.

## General-purpose sample holder (transmission)

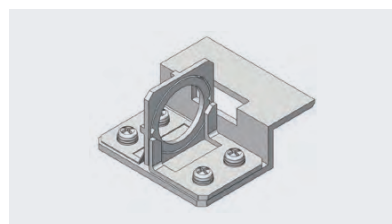

Sample holder which enables film samples or capillary samples to be positioned in the transmission configuration easily.

# Specifications

## X-ray generation\*

X-ray generator	3 kW sealed X-ray tube
Tube voltage variable range	20 - 60 kV
Tube current variable range	2 - 60 mA

## Goniometer

Configuration	Vertical type, $\theta$ - $\theta$ geometry
Radius	300 mm, 150 - 300 mm variable for 2-D experiment
Minimum step size	$\theta$ s: 0.0001°, $\theta$ d: 0.0001°
Quality assurance	Reproducibility of direct beam $0 \pm 0.005^\circ$ ( $2\theta$ )
Axis	$\theta$ s, $\theta$ d (coupled/independent)
Supported configuration for auto alignment	Bragg-Brentano Parallel beam Divergent beam Focusing Debye-Scherrer configuration SAXS/USAXS Micro-area X-ray diffraction

## Detector

HyPix-400 <sup>†</sup>	Sensor: Semiconductor pixel sensor Active area: 369.6 mm <sup>2</sup> (38.5 x 9.6 mm) Pixel size: 100 x 100 $\mu$ m Count rate: > 3.7 x 10 <sup>10</sup> cps (global), 1 x 10 <sup>6</sup> cps/pixel
D/teX Ultra250	Sensor: Semiconductor strip sensor Active area: 384 mm <sup>2</sup> (19.2 x 20 mm) Strip width: 75 $\mu$ m Count rate: > 2.5 x 10 <sup>8</sup> cps (global), 1 x 10 <sup>6</sup> cps/strip Energy resolution: $\approx 20\%$ , $\approx 4\%$ (D/teX monochromator)

## Installation requirement

Enclosure dimensions	1,270 x 1,220 x 1,880 mm, 50.0 x 48.0 x 74.0 inch (W x D x H)
Weight (without any options)	Approximately 800 kg, 1,764 lbs. for standard configuration
Cooling water supply	Min. 4.4 L/min., 0.25 MPa pressure, <20°C temperature with $\pm 0.5^\circ$ C fluctuation
Power supply	Three phases AC200 V $\pm 10\%$ , 50/60 Hz, 30 A or single phase AC220 - 230 V $\pm 10\%$ , 50/60 Hz, 40 A
Ground resistance	$\leq 100 \Omega$

## Dimensions (unit: mm)

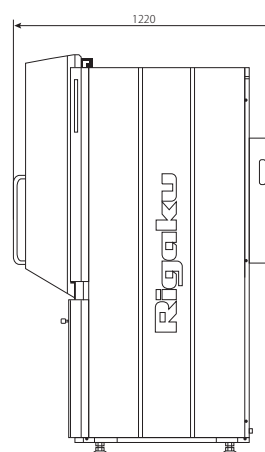
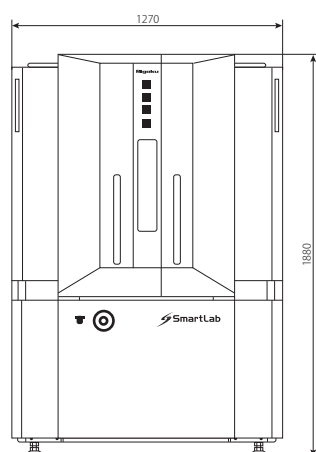

Weight (standard specification): 800 kg

\* The maximum rated values depend on the type of X-ray tube (target, focus). Please refer to the instruction manual of the X-ray tube for details.

† This product was jointly developed by Department of Measurement and Electronics, AGH University of Science and Technology (Poland) and Rigaku Corporation.

# SmartLab SE

Automated Multipurpose X-ray Diffractometer

[www.Rigaku.com](http://www.Rigaku.com)

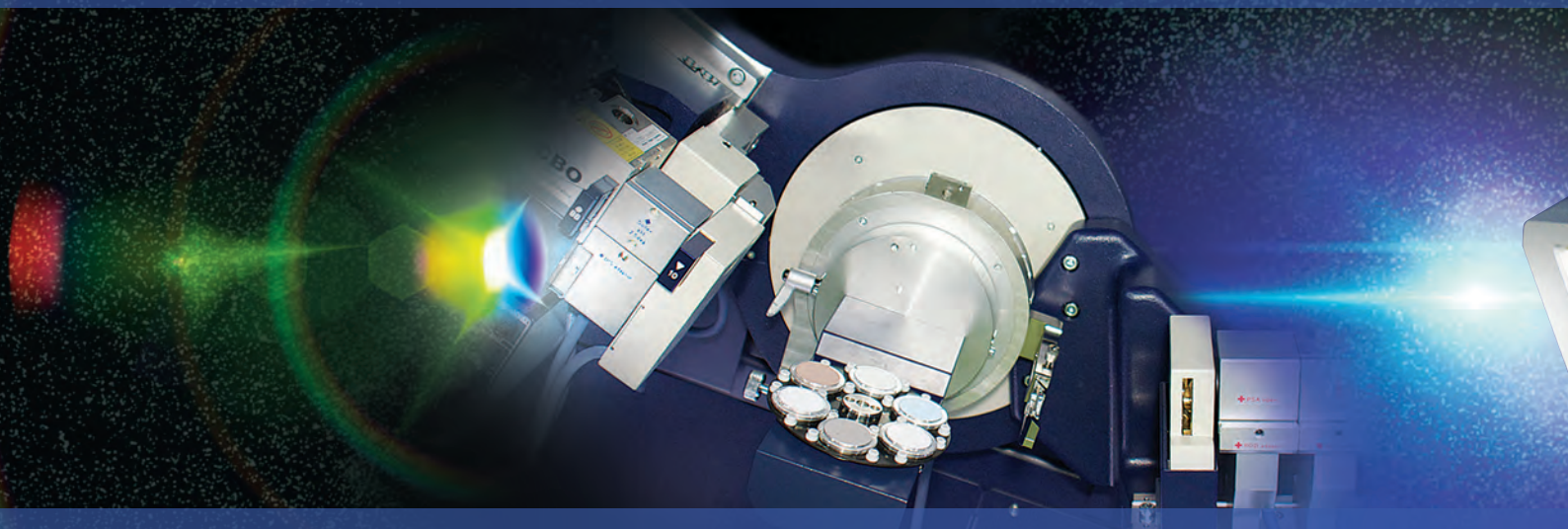

Specifications and appearance are subject to change without notice.

**Rigaku Corporation** and its Global Subsidiaries

e-mail: [info@rigaku.com](mailto:info@rigaku.com) [www.Rigaku.com](http://www.Rigaku.com)