

SWISS⁺
TECHNOLOGY

NECM SERIES
ELECTRONIC RETURN DAMPER ACTUATOR

Modulating Control
10 Nm

NENUTE[®]EC

INNOVATIVE MEMBER OF SWIS⁺TEC

NECM SERIES ELECTRONIC RETURN DAMPER ACTUATOR

Modulating Control
10 Nm

NECM...10 SERIES

NECM series actuators with Electronic Return® (ER) function are designed and produced for extended functionalities in HVAC systems: air handling equipment, fan coils and laboratory applications. Electronic Return® (ER) is able to manage short voltage interruptions for max. 10 seconds.



PRODUCT FEATURE

- Torque 10 Nm
- Damper size 2.0 m²
- Power supply AC/DC 24V
- Control Modulating Signal DC 0(2)...10 V / 0(4)...20 mA
- Shaft dimensions - Ø 10...20 mm / □ 5...14 mm
- Minimum Shaft Length 45 mm
- Adjustable angle of rotation
- Selectable direction of rotation of reversing actuator
- Actuator with 1 m cable connection
- Manual Over-ride push button when required

MODEL SELECTION TABLE

MODEL /TYPE	TORQUE	POWER SUPPLY	RUNNING TIME	RETURN	AUXILIARY SWITCH
NECM 1.1-10	10 Nm	AC/DC 24V ± 10%	65...70 sec	40 sec	-
NECM 1.1-10S	10 Nm	AC/DC 24V ± 10%	65...70 sec	40 sec	2 x SPDT (Adjustable)

DIMENSION (mm)

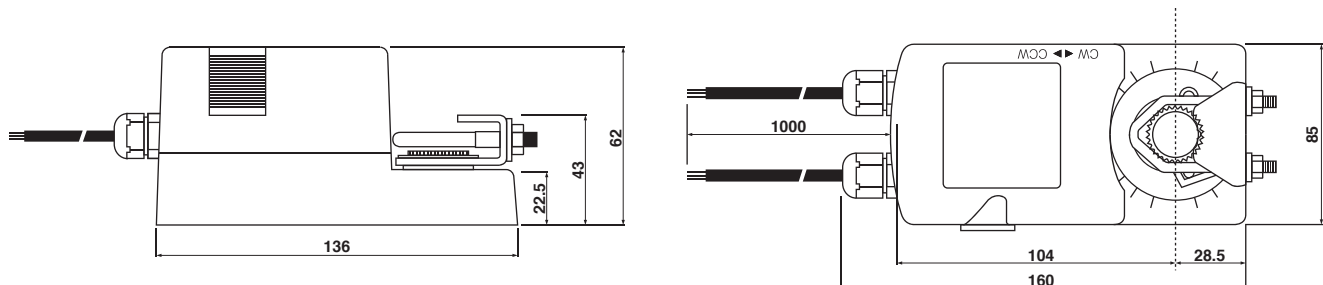

TECHNICAL SPECIFICATION

MODEL NUMBER	NECM 1.1 (S1)
TORQUE	10 Nm
DAMPER SIZE	2.0 m ²
SHAFT DIMENSION	Ø 10...20 mm / □ 5...14 mm
POWER SUPPLY	AC/DC 24 V ± 10%
FREQUENCY	50...60 Hz
CONTROL SIGNAL (INPUT)	DC 0(2)...10 V, 0(4)...20 mA
POSITION SIGNAL (OUTPUT)	DC 0...10 V
POWER CONSUMPTION	
● OPERATING	7.2 W
● END POSITION	1.2 W
FOR WIRE SIZING	10.0 VA
ELECTRICAL CONNECTION	1 m Cable
AUXILIARY SWITCH RATING	3 (1.5) A / AC 250 V
PROTECTION CLASS	Class III ⚡
ANGLE OF ROTATION	90° (95° mechanical)
WEIGHT	< 1.0 Kg
LIFE CYCLE	60,000 Rotation
SOUND LEVEL	40 dB
IP PROTECTION	IP54
OPERATING TEMPERATURE	-20°...50° as per IEC 721-3-3
NON-OPERATING TEMPERATURE	-30°...+60° C / IEC 721-3-2
AMBIENT HUMIDITY	5%...95% rH non condensing / EN
MAINTENANCE	Maintenance Free
MODE OF OPERATION	Type I / EN 60730-1
EMC	CE & ISO 9000 EN / EEC

NECM SERIES ELECTRONIC RETURN DAMPER ACTUATOR

Modulating Control
10 Nm

WIRING DIAGRAM NECM...10 (S1) POWER SUPPLY AC/DC 24V

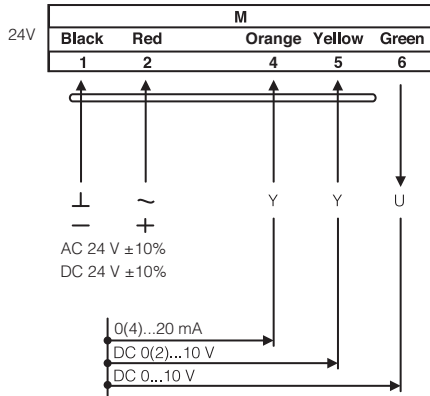

DIRECTION OF ROTATION NECM...10 (S1)

Default factory setting: CW.

Direction of rotation can be change by toggling between CW/CCW switch on the actuator's housing.

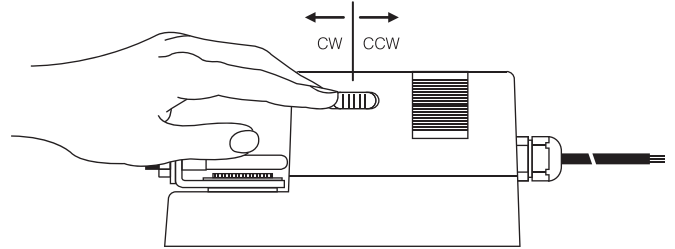

WIRING DIAGRAM NECM...10 (S1) AUXILIARY SWITCH

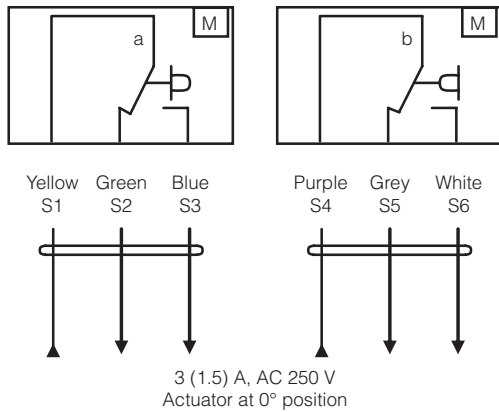

AUXILIARY SWITCH NECM...10 (S1)

Switch **a** factory-set at 5° and 85°.

The auxiliary switch can be optimally adjusted between 0°...90°.

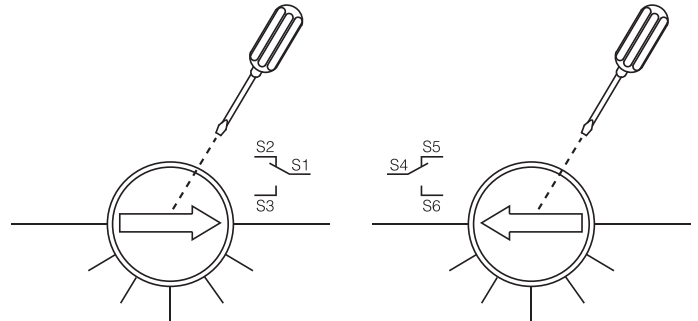

WIRING DIAGRAM NECM...10 (S1) PARALLEL CONNECTION

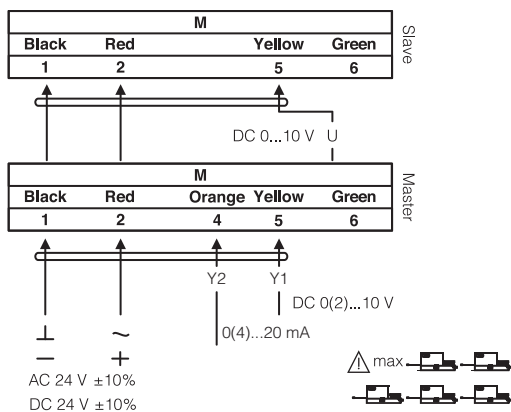

REMARK

During parallel operation, the output signal (terminal 6, DC 0...10 V) of the master actuator must be connected to terminal 5 of the next slave actuator.

RELEASING THE ADAPTER NECM...10 (S1)

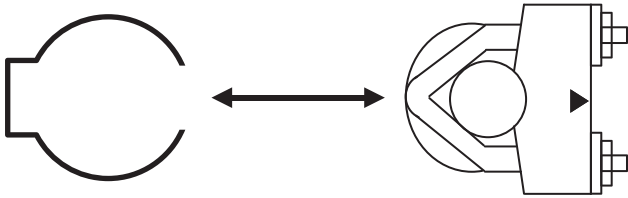

Adjusting Control Signals NECM...10 (S1)

Control Signal 5 DC 0...10V
Input Resistance Ri100k Ohm

Factory Default Setting

Control Signal 5 DC 2...10V
Input Resistance Ri500k Ohm

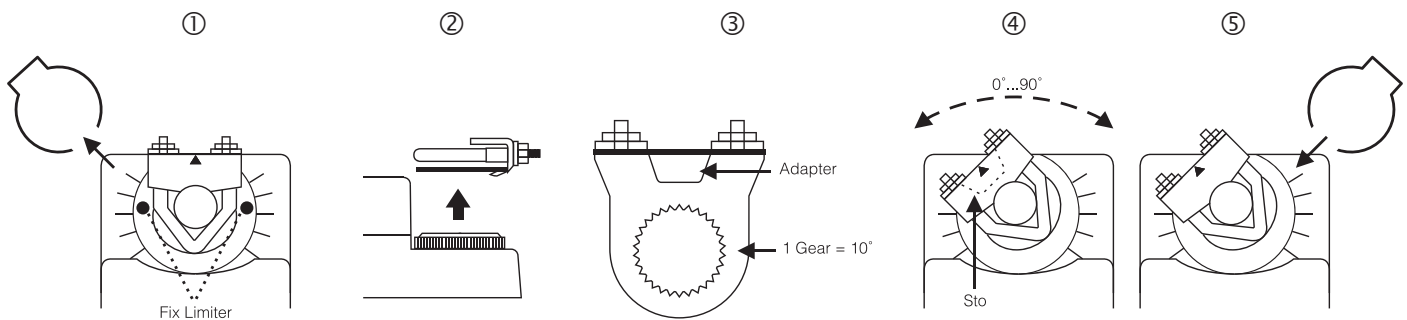

On Request

LIMITING ANGLE OF ROTATION NECM...10 (S1)



IMPORTANT REMARK

For special requirement, consult your local NenuTec's representative.

  This actuator includes electrical and electronic components and may not be disposed as household garbage. Please consider the local valid legislation.

 AC / DC 24 V: Connect via safety isolating transformer.
AC 230 V: To isolate from the main power supply, the system must incorporate a device which disconnects the phase conductor (with at least a 3mm contact gap.)

The performance specifications are nominal and conform to acceptable industry standards. NENU TEC shall not be liable for damages resulting from misapplication or misuse of its products.