

Wall Mounted Vertical Heat Recovery Ventilator Technical Manual

Models:

Comfort Fresh Air 250T

Comfort Fresh Air 350T

Comfort Fresh Air 500T



Executive Standard: EN13141-7-2010



Attention

Please read this manual carefully before using the equipment
Beijing Holtop Air Conditioning Co., Ltd.

Contents

1. General Information	
1.1 Safety Attentions	1
1.1.1 Installation	1
1.1.2 Operation	1
1.1.3 Maintenance	1
1.2 Packing List	2
2. Product Introduction	
2.1 Working principle and functions	2
2.2 Specifications	3
2.3 Dimension Drawings	4
3. Installation Instruction	
3.1 Position	5
3.2 Wall Mount	5
3.3 Ducting	5
3.4 Electric	6-8
3.5 Condensate drainage	9
4. Operation instruction	
4.1 Before startup	10
4.2 Default setting	10
4.3 Operating instruction	10-12
4.4 APP Instruction	13
4.5 RS485 Protocol	14-18
5. Maintenance	
5.1 Filter Replacement	18
5.2 Drain Pipe Inspection	19
5.3 Inspection of air duct, air inlet/outlet	19
5.4 Heat exchanger cleanness	19
6. Failure diagnosis	20
7. Optional Accessories	21

General Information

1. General Information

1.1 Safety Attention

Please read the following safety instructions carefully before installation. Please observe all instruction in order to avoid any injury or damage to equipment or property.



Warning/Attention, a risk of injury or equipment damage.

1.1.1 Installation

- Installation and maintenance to be carried out by qualified person to avoid danger, end users should not install this equipment by themselves.
- This equipment should be connected to power supply by the qualified electrician, and it should be grounded.
- It shall be moved and installed according to the weight and size of the product.
- The equipment should be installed in accordance with the installation instructions (chapter 3).
- The equipment should be installed in a dry place indoors, not in a place where there may be flammable gas leakage.
- A bird net or similar device should be installed at the vents of outdoor. When there are nests and obstructions there, please clean them, otherwise it will cause indoor hypoxia.

1.1.2 Operation

- Children, persons with reduced physical sensory/mental abilities or lack of experience and knowledge are prohibited from using this product unless they are supervised or guided by the person responsible for their safety.
- Must use rated voltage, otherwise it may cause fire or electric shock.
- Shall replace the filter at the recommended/required interval.
- Do not use corrosive or solvents to clean the equipment.
- Do not touch the equipment with wet hand.





1.1.3 Maintenance

- If there is abnormal noise, smell or smoke, please cut off the power supply and contact the installation technician.
- Power Supply should be cut off before maintenance (charter 5).
- It is forbidden to modify the unit. A qualified professional must use the original spare parts provided by the manufacturer to replace the parts.

Product Introduction

1.2 Package

The package includes the following items. Please check when open the box. In case of damage or incomplete delivery, please contact your supplier immediately.

	HRV 1pic Please check the sticker and model to make sure they are correct.
	Mounting bracket 1 piece
	Condensate drain connector (with seal ring) 1 piece
	Condensate drain seal (with seal ring) 1 piece
	Manual 1 set

2. Introduction

2.1 Principle and functions.

This unit is designed to provide mechanical supply and extract ventilation with heat recovery. It is equipped with heat exchanger, filters and EC motor, etc. It has functions as below:

- Fresh air purification: after the outdoor air driven by supply fan and go through the filter, the indoor air quality will highly improved.
primary filter
- Energy recover: the unit is equipped with heat exchanger, which can recover the energy of EA and then recycle to OA, this function will greatly decrease the loss of energy.

Product Introduction

2.2 Specifications

		CFA 250T	CFA 350T	CFA 500T
Machine	Housing material	Sprayed sheet metal		
	Internal materials	EPP		
	Heat exchanger materials	Polystyrene		
	Fan motor type	EC		
	Filter class	G4 or optional F7		
	Control Panel	Two screen controls, buttons + indicator light/digital tube		
	Bypass	100% auto bypass		
Working conditions	Standard	-10 to 40°C		
	Equipped with duct type heater	-20 to 40°C		
Pipe connection	Pipe diameter	Φ160mm		Φ200mm
Electrical parameters	Power supply	230V 50Hz 1Ph		
	Max. power	137W	272W	412W
	Max. current	1.0A	1.9A	2.9A

Product Introduction

2.3 Dimensions

CFA 250T and CFA 350T

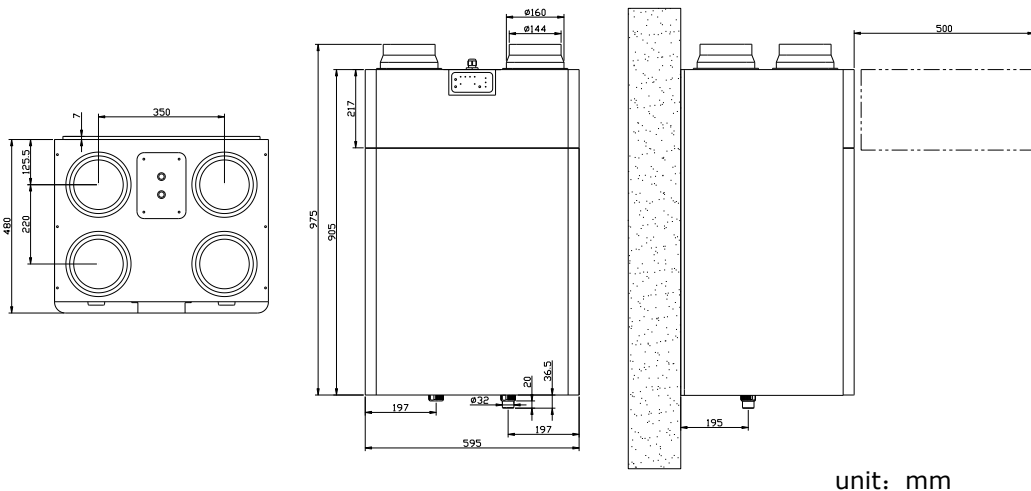

CFA 500T

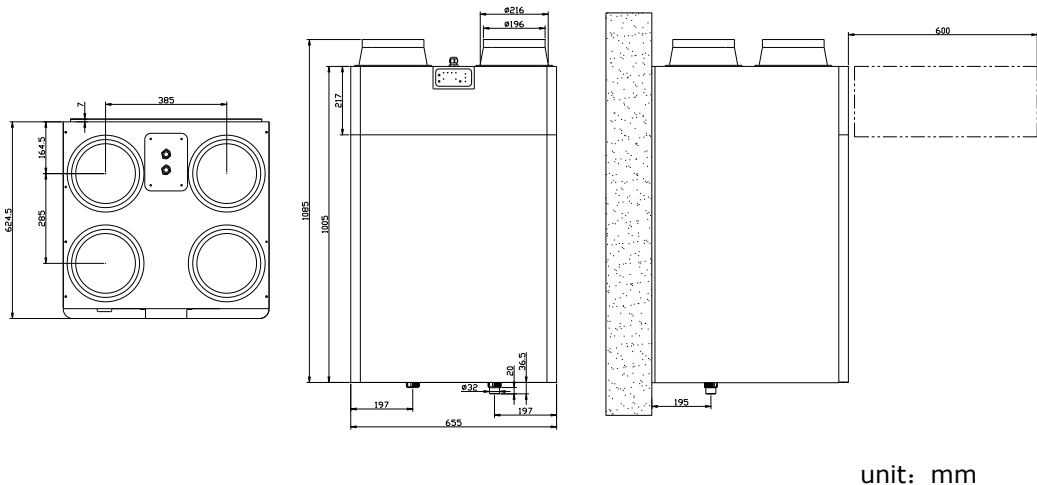

Installation Introduction

3. Installation

3.1 Position

- All installation of the system must be carried out by qualified personnel, including all electrical engineering and connections should be completed by qualified personnel or Electrician.
- This equipment is designed to be installed in storage rooms, attic or interstitial spaces, away from places exposed to frost, water or extreme heat.
- The operation space should be reserved around the equipment to facilitate the placement and connection of piping systems, cables and condensed water drainage. At the same time, it's easy to replace the filters.
- The installation position can drain condensate water.

3.2 Hanging Installation

- The equipment should be installed vertically on the wall.
- The equipment is hung on the wall with a hanging plate (the wall must be weighted at 60kg above), the size of the hanging plate is shown on the right.

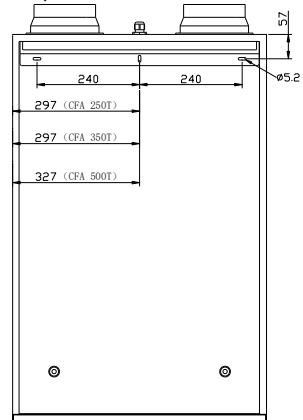

3.3 Pipes

- The equipment allows the user to adjust the position of the air inlet and outlet by himself, and the user first needs to select and install the pipe, then adjust the filter position, finally follow the operation note (4.3) to select the corresponding control program.

Note 1: This equipment factory default right pipe installation.

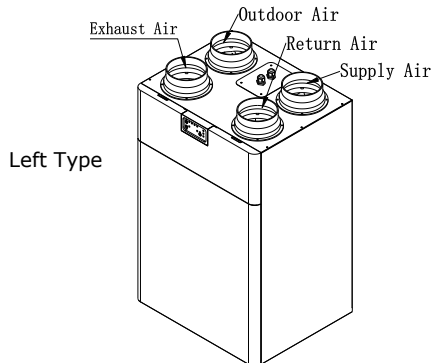
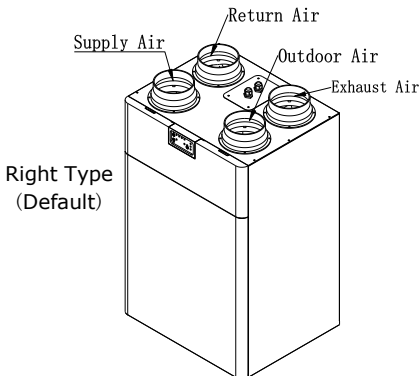

Installation Introduction

The operation process from right installation (factory default) to the left installation is as follows:

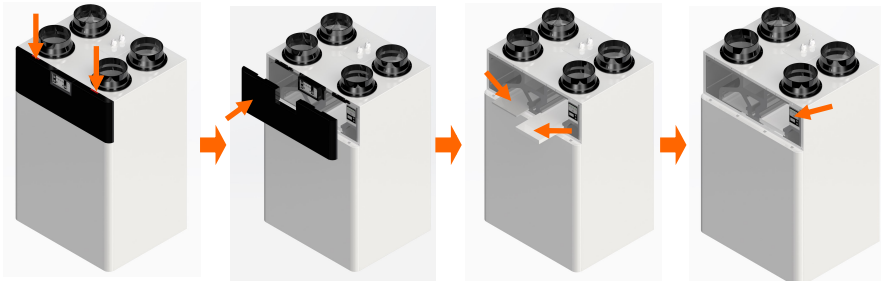

Step 1: Press the position indicated in the figure above to open the access panel buckle.

Step 2: Remove the access panel.

Step 3: If the equipment is equipped with an F7 filter as option, switch the positions of the two filters as shown in the figure. Note if both filters are G4 grade, this step can be ignored.

Step 4: Use the hidden control panel at the top right corner, follow the instructions (4.3) to select the corresponding control program.

Step 5: Install the filter and access panel back to the unit.

3.4 Electric

- Power supply of this equipment should be connected by a qualified electrician, and the equipment must be grounded.
- Use national standard cables, cable $3 \times 1.5 \text{mm}^2$.
- Power supply: 230V/50Hz/1Ph
- L line=Brown, N line=Blue, GND line=Yellow&Green
- The electric circuit must be protected by a bipolar circuit breaker.

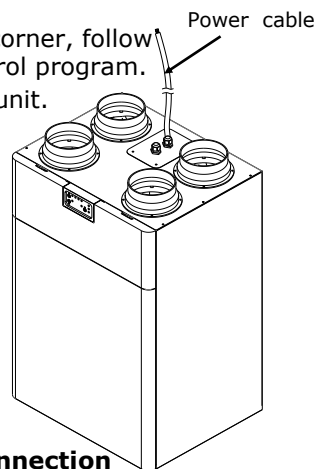

Remote touch screen control panel (optional) connection

This product can be equipped with touch screen remote controller, connected through the control cable. The connection process is as follows and should be operated by a qualified electrician:

Step1: Cut off the power.

Step2: Use a screw driver to remove the screws which fixing the cover of the electric control box at the top.

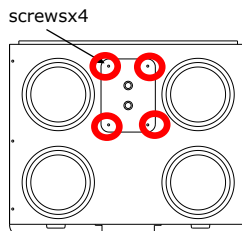

Installation Introduction

Step3: Pull out the sockets from PCB for use.

Step4: Open the controller casing.

Open the controller casing from here

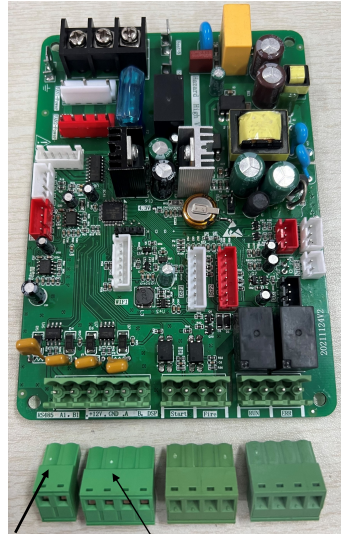
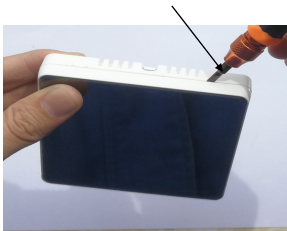

RS485 sockets

Sockets for remote control

Step5: Connect the wires between controller and sockets (PCB) according to "B, A, GND and +12V".

Note: All the wires need to pass through the threading connector on the cover of the electric control box, and tighten the threading connector.

Back of the controller PCB

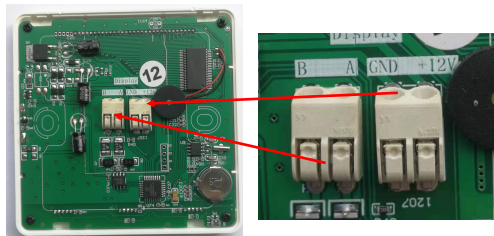

Sockets for remote control

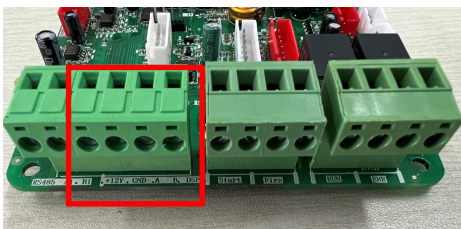

+12v GND A B

Wiring sequence

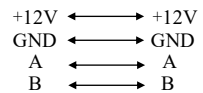

Installation Introduction

Step6: Finally, plug the sockets that has been wired back into the PCB, and cover the electric control box.

Wiring Diagram

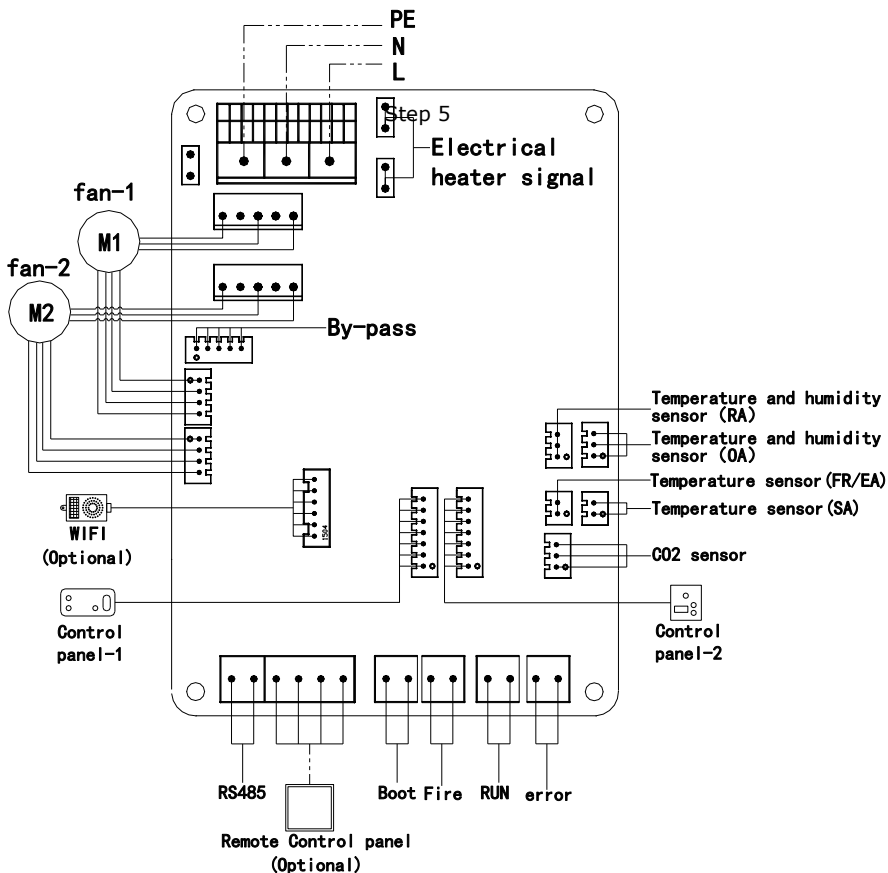

Note:

1. CO2 sensor is optional for this device.
2. Duct heater (provided by user) should be connected to the relays before connecting to the PCB board. Please refer to the wiring diagram or contact our sales for more information.

Installation Introduction

3.5 Condensate drainage

Before using, make sure to connect a condensate drain with this device. The connection process for condensate drain is as below:

- According to the installation way, install the drain connector and drain seal to the corresponding position.

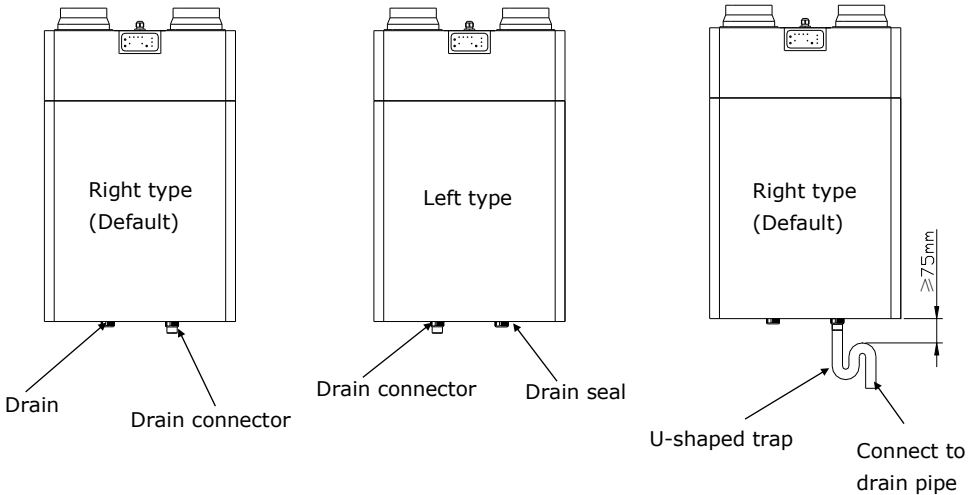

- Use a U-shaped trap to connect the drain connector and the drain pipe.
- Before using the device, make sure to immerse the drain pipe in water.
- Make sure that all connectors are tightly sealed to prevent water leakage.

Operation

4. Operation Instruction

4.1 Before Startup

Please carefully check the followings:

- Check the voltage and frequency of the power source and its connection if is correct.
- Should be properly connected to the ground line.
- Connected to ducting and condensation pipe properly

4.2 Default factory setting

The device comes with below default setting:

		CFA 250T	CFA 350T	CFA 500T
Airflow m ³ /h	SPEED 1	80	100	105
	SPEED 2	100	130	185
	SPEED 3	145	180	270
	SPEED 4	175	245	350

4.3 Operation Instruction

The device has two controller panels, Panel 1-Daily simple settings, Panel 2-Advance parameters settings. Positions are as followed:

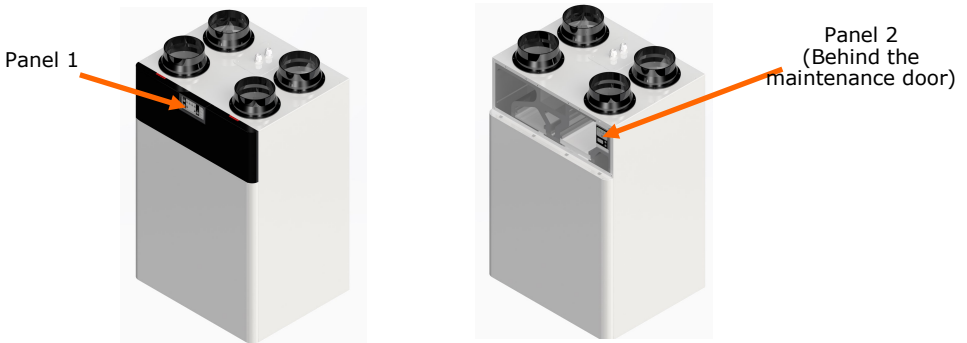

Operation

Panel 1 Instruction

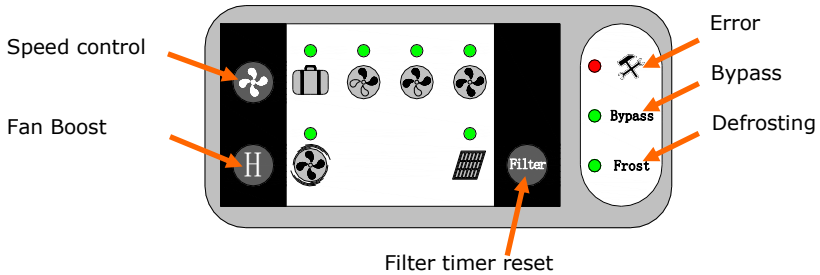

Speed control: Press to switch from Speed 1 to 4, speed 1 is “traveling mode”, when switch to this mode, the ventilator turns to super low speed.

Fan Boost: Press to switch to the boost speed for 30 minutes, and then return to original status.

Filter timer reset: After 60 days running, when the filters is needed cleaning or replacement, the light will be illuminated. After replacement or cleaning, hold this button for long time to reset the filter timer.

Error Indicator: When it’s illuminated, the fan or the sensors are in error, the indicator lights off after error cleared.

Bypass: When bypass is on, it will be illuminated. When bypass is off, then the light is off, bypass opening temperature: Outdoor 17 to 21 degree Celsius.

Humidity control: when the ventilator is running, if indoor humidity over 75%RH, ventilator will enter the boost speed, until the humidity lower than 75%RH.

CO2 control (optional): By connecting a CO2 sensor to it, when the ventilator is running, if the indoor CO2 value over 1000PPM, ventilator will enter the boost speed, until the CO2 value lower than 1000PPM.

Defrost: When defrost mode is activated, it will be illuminated. Defrost mode activated temperature: Outdoor less than or equal to -5degree Celsius.
Note: In order to prevent frost inside the device, the ventilator is in automatic adjustment and cannot be operated when in defrost mode.

The above values are default values, user can change the default values by optional touch screen controller or Modbus system.

Operation

Panel 2 Instruction

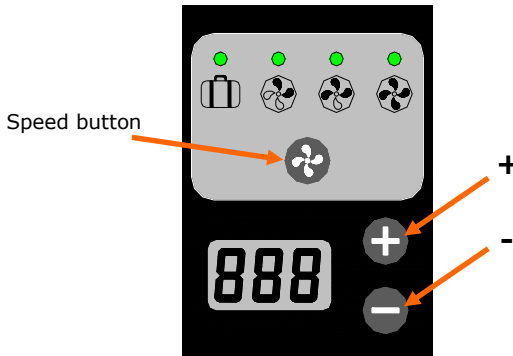

Air volume setting: Press "Speed" to select speed 1 to 4, then press "+" or "-" to set air volume for the selected speed, after 4 speeds setting done then press "Speed" again to save setting or it will be automatically saved after 15 seconds without operation.

Balance rate setting: Long press the "Speed" button for 6 seconds when the digital display shows "LPL", press "+" or "-" to set the air volume balance rate of supply and exhaust.

- 1) The value is 0, then supply airflow is equal to exhaust airflow.
- 2) The value is 1 to 50, then supply airflow is larger than exhaust airflow.

Note: the larger the value, the smaller the exhaust airflow.

- 3) The value is -50 to -1, then supply airflow is less than exhaust airflow.

Note: the larger the absolute value, the smaller the supply airflow.

Right and left installation switching: Long press the "+" key for 6 seconds when the digital display shows "PLP", press "Speed" button to switch between the right and left installation modes. The number 1 represents the right type, and the number 2 represents the left type.

Note: The setting must be consistent with the installation form, otherwise, it will affect the use of the ventilator.

Restore factory settings: press the "Speed" "+" and "-" buttons at the same time, the air volume and air volume balance rate will return to the factory default settings.



RS485 address setting: Long press the "-" key for 6 seconds, press "+" or "-" to set the RS485 address of the ventilator for centralized control.

Operation

4.4 APP Instruction

- 1) Search "SMART LIFE" at the APP Store or scan the QR code on the right to download the APP.
- 2) Sign up and log in your account.
- 3) Install the WIFI module onto the PCB board, as indicated in the wiring diagram.
- 4) Check if the indicating light is blinking; if not, long press the black reset button in the WIFI module until the light is blinking constantly.
- 5) Open "SMART LIFE" APP, press  and then go to "Small Home Appli-



- ances" and select  "Ventilation system(BLE+WI-FI)".
- 6) Choose the correct device hotspot, which is normally named "SmartLife-xxx", Until the hotspot is successfully connected. Press "Return" at the top left corner to return and wait for the ventilator to be connected to the mobile phone.
- 7) After the connection is successful, press  to edit the ventilator name, and press "Done" to enter the ventilator control page.
- 8) Then user can go to the device's page for all the functions.

Reset Button

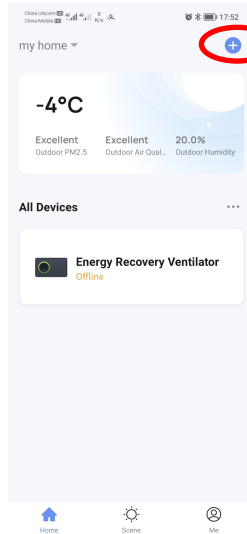

Operation

4.5 RS485 Protocol

MODBUS-RTU Protocol details are as followed.

No	Item	Specifications
1	Interface	Half-Duplex RS-485
2	Baud Rate	9600
3	Transmission	RTU (Remote Terminal Unit)
4	Data Stream	Address+Function code+Data quantity+Data 1...Data n+CRC MS byte+CRC LS byte
5	Address	0-99
6	Function code	3, 6
9	CRC Check sum	CRC-16
10	Byte format	10bit format: 1 start bit+8 data bit+1 stop bit
11	Check sum	CRC-16
12	0XFF address	Broadcast Address
13	Inter-face definition	A(+), B(-), two-wire system

Operation

Address	Range	Default	Function	Remarks
0(0x0000)	0, 1	/	0=OFF 1=ON	
1(0x0001)	0-250	/	Filter used time (day)	Every setting will reset the current alarm
2(0x0002)	0-120	60	Filter replacement alarm (day)	0=Alarm off
3(0x0003)	0, 1	0	0=Filter normal 1=Filter needs cleaning	
4(0x0004)	0-120	/	EA Temperature(°C)	Data \geq 20, actual temperature=data bit-20; Data<20, actual temperature=20-data bit
5(0x0005)	0-120	/	SA Temperature(°C)	
6(0x0006)	0-100%	/	OA Humidity	
7(0x0007)	-20-60°C	/	OA Temperature(°C)	Data \geq 20, actual temperature=data bit-20; Data<20, actual temperature=20-data bit
8(0x0008)	0-100%	/	RA Humidity	
9(0x0009)	-20-60°C	/	RA Temperature(°C)	Data \geq 20, actual temperature=data bit-20; Data<20, actual temperature=20-data bit
10(0x000a)	0-2000	/	CO2 Concentration (PPM)	
11(0x000b)	1-4	/	Volume setting for Speed 1-4	
12(0x000c)	0-5	/	Running speed	5=Fan boost
13(0x000d)	15-30	16	Temperature setting for heater(°C)	
14 (0x000E)	0-120	30	Fan boost Duration (mins)	

Operation

15 (0x000F)	/	/	Bit0=OA temp and hum error Bit1=RA temp and hum error Bit2=OA temp error Bit3=RA temp error Bit4=CO2 sensor error Bit5=reserved Bit6=Bypass on Bit7=Electric heater on Bit8=Supply fan error Bit9=Exhaust fan error Bit10=Fire alarm signal Bit11=Forced ON signal Bit12=Running signal output Bit13=Error output Bits are valid.	Fixed position are not affected by left or right type.
16 (0x0010)	0, 1	1	0=Conventional Defrost OFF 1=Conventional Defrost ON	
17 (0x0011)	15-99	30	Defrosting interval (mins)	
18 (0x0012)	11-30	25	Defrosting entering temperature (°C)	11=-9°C 12=-8°C 20=0°C 25=5°C
19 (0x0013)	2-20	10	Defrosting Duration (mins)	
20 (0x0014)	0, 1	1	0=Humidity Check OFF 1=Humidity Check ON	
21 (0x0015)	50-99%	75	Humidity Setting Value	
22 (0x0016)	0, 1	0	0=CO2 Concentration check OFF 1=CO2 Concentration check ON	
23 (0x0017)	800-1900	1500	Co2 Setting Value (PPM)	
24 (0x0018)	0, 1	1	0=Manual Bypass 1=AUTO Bypass	When manual bypass is off, AUTO bypass will be valid.
25 (0x0019)	5-30	19	Bypass opening temperature (°C)	

Operation

26 (0x001 A)	2-15	3	Bypass temperature difference (°C)	
27 (0x001 B)	0, 1	0	0=Electric Heater OFF 1=Electric Heater ON	
28 (0x001 C)	0, 1	0	0=Manual Bypass OFF 1=Manual Bypass ON	
29 (0x001 D)	0-10000	/	Fan 1 output voltage	10000=10.00v
30 (0x001 E)	0-10000	/	Fan 2 output voltage	10000=10.00v
31 (0x001 F)	0-2	Already selected based on model during production	Model selection 0=250CHM 1=350CHM 2=500CHM	
32 (0x002 0)	0-9999	/	Electricity Consumption (Heater not included) (Kw/h)	
33 (0x002 1)	0-9999	/	Heater Electricity Consumption (Kw/h)	Heater capacity needed
34 (0x002 2)	500-3000	250CHM-0.8kw 350CHM-1kw 500CHM-2kw	Heater Capacity of heater (Kw)	Can be set accordingly to actual case
35 (0x002 3)	10-30	15	Forced Defrosting temperature (°C) (OA Temperature)	11=-9°C 12=-8°C 20=0°C 25=5°C
36 (0x002 4)	0-12	2	Forced Defrosting interval (hour)	

Maintenance

5. Maintenance

5.1 Filter replacement

It's recommended that all filters be inspected every 3 months and replaced once or twice a year, or be replaced when the "filter alarm" indicator on the control panel illuminated. Otherwise the performance or energy efficiency of the ventilator might be affected.

Step 1: Press the two buckles at the top to remove the maintenance panel.

Step 2: Take out the SA/RA/bypass filter

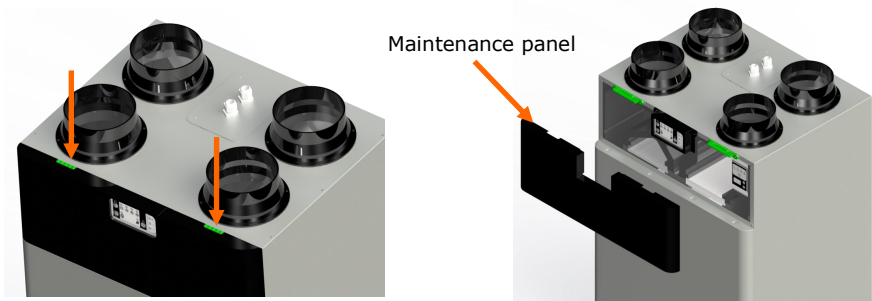

Step 3: Put the filters back in place after cleaning or replacing, re-install the maintenance panel, then reset the time of the filter alarm (Refer to instruction 4.3).

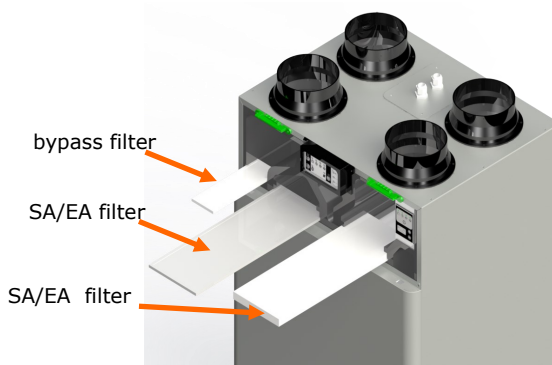

Maintenance

5.2 Drain pipe inspection

It's recommended that the condensate drain pipe should be inspected once or twice a year, preventing the leakage due to poor drainage.

5.3 Air duct, air inlet/outlet inspection

It's recommended that the air duct, air inlet/outlet should be inspected regularly, preventing the abnormal ventilation of the equipment due to blockage.

5.4 Heat exchanger cleanness

The heat exchanger needs cleanness and maintenance regularly, it's recommended that the heat exchanger should be cleaned or maintained every 3 years. Please contact our service center if needed.

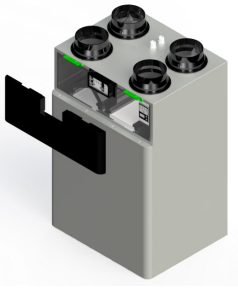

A. Remove the maintenance panel



B. Remove the front panel

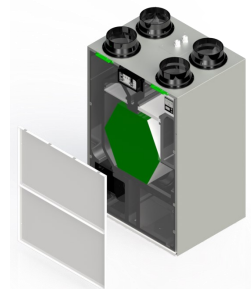

C. Remove the sealing plate

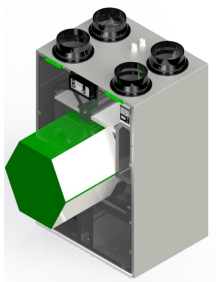

D. Pull out the heat exchanger

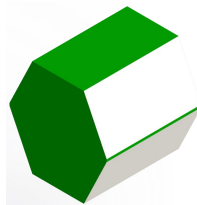

E. Clean the heat exchanger with a vacuum cleaner

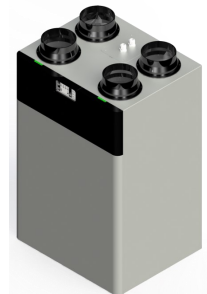

F. Put all the parts back in place

Failure Diagnosis



6.Fault diagnosis

Please inspect the machine refer to the table below if this product works abnormally, and contact our service center to solve the problem in time.

Phenomenon	Possible reasons	Solutions
Filter reset indicator light on	- Filter should be cleaned or replaced	- Clean or replace the filter, refer to 5.1
Error light on	- Fan error - Sensor error	- Restart the equipment, if still unsolvable, contact our service center directly
Insufficient fresh air	- Air inlet/out was blocked Filter clogged -Filters clogged by dusts	- Inspect and remove the unidentified matters - Replace the filters
No response to fan speed selection	- The device is in special working mode, like defrosting mode	- Wait until the special mode finished
Drop noise	-Condensate drain pipe clogged	Dredge the pipeline
Working noise	The pipe connected to the device is not firmly fixed - Unidentified matters enter into the internal of the device - SA fan or EA fan malfunction	- Unpack the device, clean the inside or replace the parts
The device fail to start	- Power wiring error - Equipment protection circuit trip	- Inspect the wiring - Close the protective circuit breaker

Optional accessories

Users can configure the following accessories optionally according to their need.

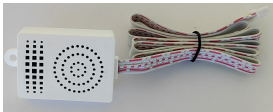
No.	Picture	Descriptions
1		F7 filter for fresh air purification
2		Remote touch screen controller
3		CO2 sensor with 5 meter wire
4		WIFI Module

205013365003