

Шкаф-купе/ wardrobe-sliding VICTOR

Код ТН ВЭД ЕАЭС

9403 60 100 1
9403 90 300 0



отрезать
и приклеить

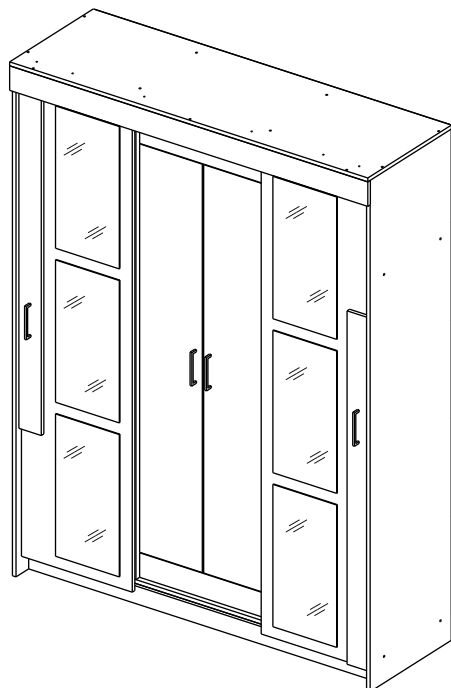

| | | |
|------|------|-----|
| | | |
| 1600 | 2100 | 526 |

36ШКСБ / 3252

36ШЯ / 3255

Комплектовочная ведомость / Set package sheet

| Упак/ Package | Наименование | Description | Цвет детали/ Décor | Размер / Size, mm | Кол-во/ Quantity | № |
|------------------|------------------|------------------------------|-----------------------|----------------------|---------------------|----|
| 1 | Бок | Side | Sonoma | 2084x506 | 2 | 1 |
| 2 | Бок левый | Side left | Sonoma | 1968x456 | 1 | 2 |
| | Бок правый | Side right | Sonoma | 1968x456 | 1 | 3 |
| 3 | Крыша | Top | Sonoma | 1600x522 | 1 | 4 |
| | ХДФ | Back element | White | 1596x399 | 5 | 16 |
| | Ходовой профиль | Upper track | - | 1514 mm | 1 | - |
| | Профиль Ш-образн | Double running track | - | 1514 mm | 1 | - |
| | Штанга | wardrobe tube | - | 480 мм | 2 | 17 |
| | Вязка | Connecting element | Sonoma | 1566x456 | 1 | 5 |
| 4 | Вязка | Connecting element | Sonoma | 484x456 | 2 | 6 |
| | Фурнитура | Furniture/Cabinetry hardware | - | - | 1 | - |
| | Вязка | Connecting element | Sonoma | 566x414 | 1 | 7 |
| | Планка | Plank | | 566x100 | 1 | 9 |
| | Планка | Plank | | 566x200 | 1 | 10 |
| | Полка | Shelves | | 566x414 | 2 | 11 |
| 5 | Створка | Door | White | 1968x495 | 2 | 12 |
| | Планка | Plank | Sonoma | 1600x100 | 1 | 8 |
| | Створка | Door | White | 1440x100 | 2 | 14 |
| | Створка | Door | White | 1664x280 | 2 | 13 |
| | Цоколь | Socle | Sonoma | 1566x100 | 1 | 15 |

Продается отдельно/Sold separately

| | | | | | | |
|---|-----------|------------------------------|---|---------|---|----|
| 1 | Зеркало | Mirror | - | 580x285 | 6 | 18 |
| | Фурнитура | Furniture/Cabinetry hardware | - | - | 1 | - |

(PL) Instrukcja montażu

(CZ) Návod k montáži

(D) Montageanleitung

(GB) Assembly instruction

(F) Model d'emploi

(HU) Szerelési útmutató

(I) Istruzione di montaggio

(NL) Handleiding voor de montage



(RU) Инструкция по монтажу

(RO) Instrucțiuni de montare

(SK) Návod k montáži

(TR) Montaj talimatı

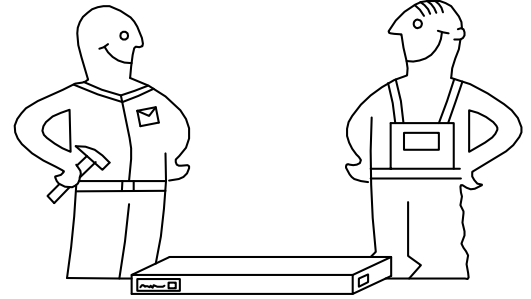
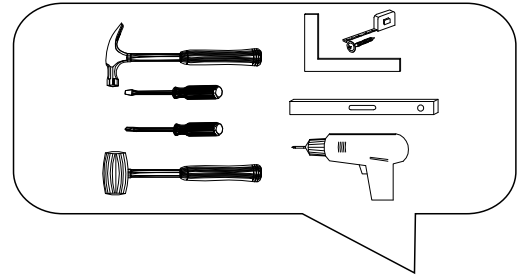



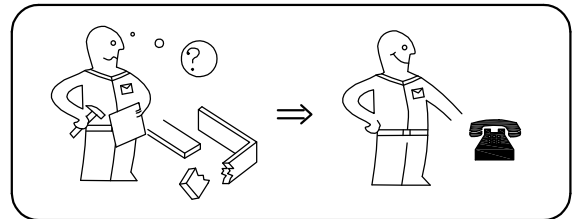
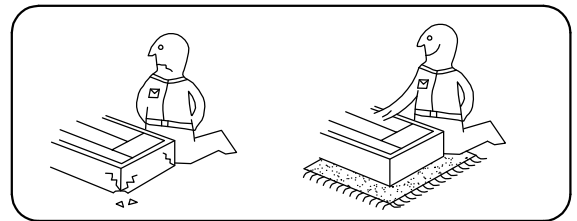



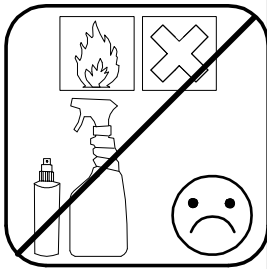
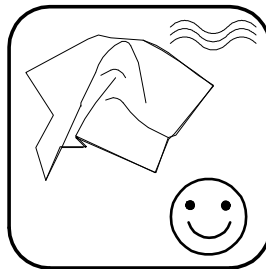
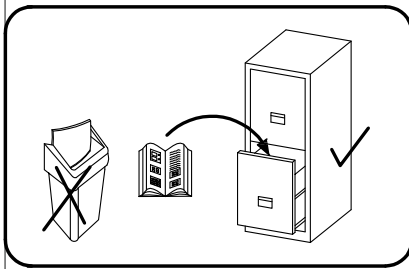

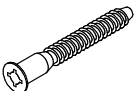
| ⚠ Uwaga • Upozornění • Achtung • Attention • Caution • Figyelem Attenzione • Opgelet • Внимание • Atenție • Upozornenie • Dikkat ⚠ | |
|--|--|
| PL | Czyszczenie należy wykonać wyłącznie za pomocą ściereczki lub lekko nawilżonego ręcznika. Nie stosować środków czyszczących do szorowania. |
| CZ | Čistění je nutné vykonávat výhradně pomocí utěrky nebo lehce navlhčeného ručníku. Nepoužívejte čističe obsahující abrazivní částice. |
| D | Bitte nur mit einem Staubtuch oder leicht feuchtem Lappen reinigen. Keine scheuernden Putzmittel verwenden. |
| GB | Please only clean with a duster or a damp cloth. Do not use any abrasive cleaners. |
| F | Le nettoyage se fait uniquement à l'aide d'un torchon ou d'une serviette légèrement mouillée. |
| HU | A tisztítás kizárólag törülköh vagy enyhén nedvesített törölköző segítségével végezhető. Súroló hatású tisztítószerket nem szabad használni. |
| I | Pulire esclusivamente con un panno o un asciugamano umido. |
| NL | Reinig alleen met een stofdoek of een lichtjes vochtige doek. Gebruik geen schurende poetsmiddelen. |
| RU | Очищайте от пыли тряпкой или слегка влажной ветошью. Не допускается применение чистящих средств, не предназначенных для ухода за мебелью. |
| RO | Curățarea trebuie efectuată numai cu o cârpă sau cu un prosop ușor umezit. Nu utilizați agenți de curățare abrazivi. |
| SK | Čistení je nutné vykonávať výhradne pomocí utierky alebo ľahko zvlhnutým ručníkom. Nepoužívajte čistiace prostriedky obsahujúce abrazívne častice. |
| TR | Lütfen sadece bir toz bezilye veya hafif nemli yumuşak bir bezle siliniz. Aşındırıcı temizlik malzemeleri kullanmayınız. |

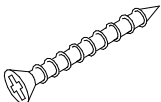
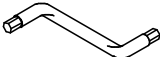
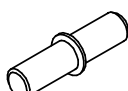

Karta serwisowa • Servisní list • Service Karte • Service card • Carte de service • Szervizkártya
Scheda di servizio • Service kaart • Сервисная карта • Fisa service • Servisný list • Servis karti

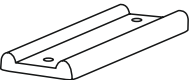
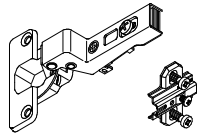
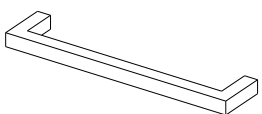
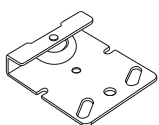

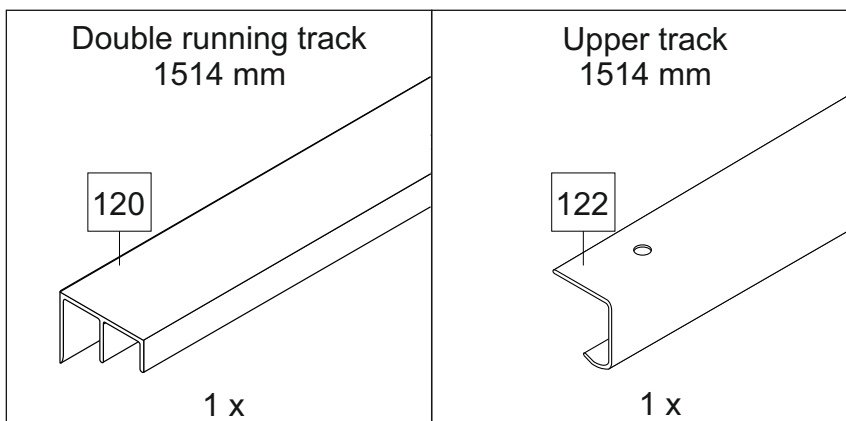

| | | | | | | | | | |
|---|---------|---|------------|---|--------|---|--------|---|--|
| 5 | 7x50 | 6 | 6,3x10,5 | 18 | 3,5x15 | 10 | 3,5x25 | 15 | |
|  | |  | |  | |  | |  | |
| 42 x | | 34 x | | 30 x | | 8 x | | 1 x | |
| 39 | DUPLO | 48 | 2x20 | 49 | | 72 | | 76 | |
|  | |  | |  | |  | |  | |
| 8 x | | 100 x | | 4 x | | 36 x | | 7x | |
| 90 | Hinge C | 126 | C42 128 mm | 51 | | 52 | | | |
|  | |  | |  | |  | | | |
| 6 x | | 4 x | | 4 x | | 4 x | | | |



Напр. профиль
(Ш-образный) 1514 мм

Ходовой профиль
(однополосной) 1514 мм

| | | | |
|---|--------|---|-----|
| 77 | mirror | 83 | 2 m |
|  | |  | |
| 1 x | | 1 x | |
| package mirror | | | |

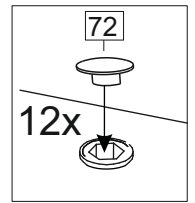
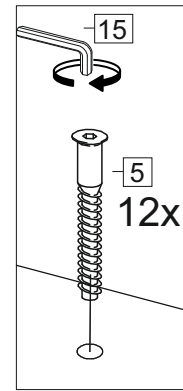
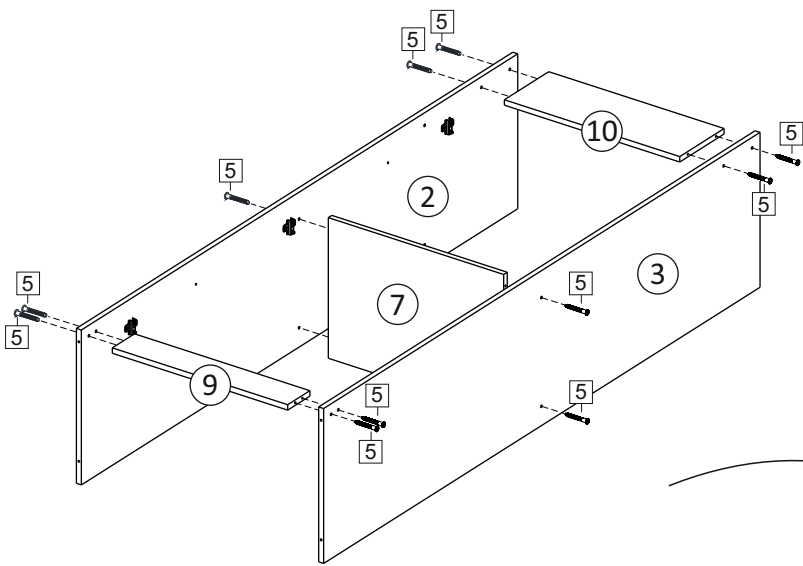
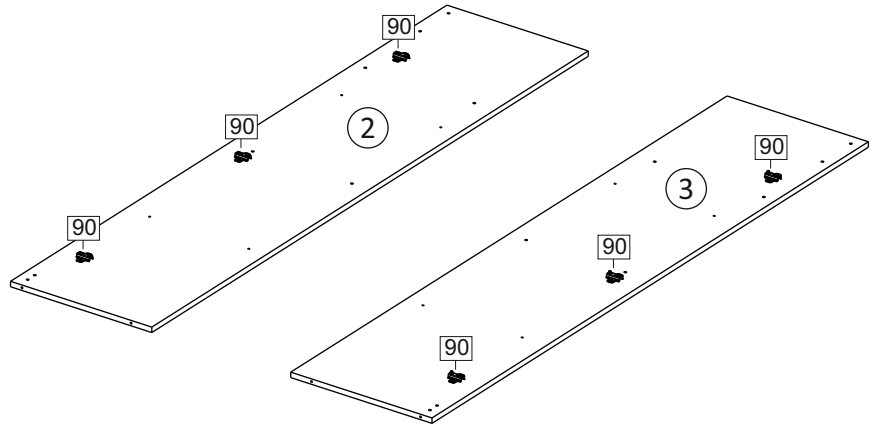
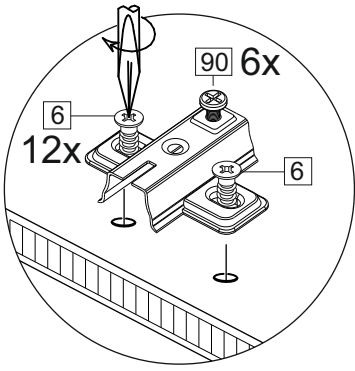

180°

