

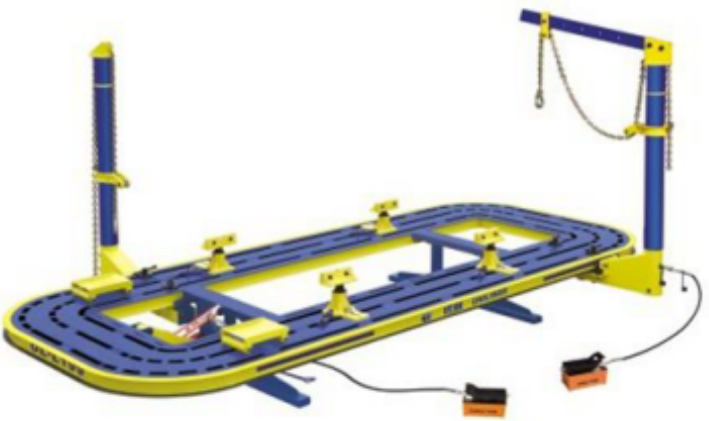

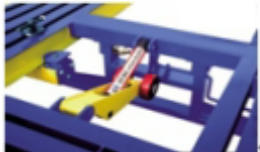

# TOP AVTO GT19I

Configuration List

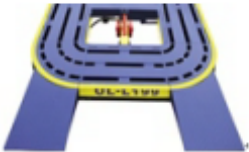

No.	Parts included	Quantity (set)	Remark
1	GT19I	1	
			
1)	Fixed support leg	1	
2)	Movable support leg	1	
3)	Tilt-lift platform (include oil cylinder)	1	
4)			



2	360°rotation Pulling towers	2	
1)	Push rod of cylinder	2	
2)	Bolts for fixing towers	4	
3)	Bolt plates for fixing towers	4	
4)	Nut for fixing towers	4	
5)	In-built adjustable collars	2	
6)	Protective wire	2	
7)	3.5M chain	2	
8)	10T high-pressure oil cylinder	2	
9)	3.5m main chain(with chain hook)	2	





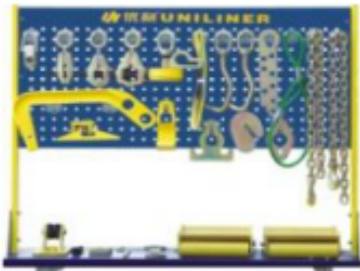



Configuration List











3	Tiger style main clamp	4	
1)	Foot for fixing jaws clamp(M12bolts)	4	
2)	Screw clamp of tiger main clamp	4	
3)	Bolts, pressure plate, nut for fixing jaws main clamp	4	
4	Pneumatic hydraulic pump (include oil pipe、 quick couplers)	2	
5	Pothook	19	
6	Tools board & accessories	1	



Configuration List

Configuration List

1)	1.2M Chain with rake body	2	
2)	Small clamp	1	
3)	Mini clamp	1	
4)	Wide clamp	1	
5)	C - clamp	1	
6)	Big bending hook (1-3)	1	
7)	Deep hook	1	
8)	Slotted chain anchor	1	

9)	Multi hole pull plate	1	
10)	Nylon sling	1	
11)	Steel wire	1	
12)	Handy link	1	
13)	Big spanner	1	
14)	Double connector	1	
15)	Down-pulling Device	1	
16)	strut puller kit	1	

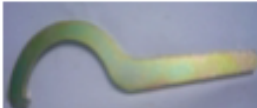
Configuration List

17)	Wheel dolly	2	
18)	Crescent spanner	1	
7	Data base	1	
	Operating manual	1	