

EVS | ELECTRONIC FAN SPEED CONTROLLER

Mounting and operating instructions



Table of contents

SAFETY AND PRECAUTIONS	3
PRODUCT DESCRIPTION	4
ARTICLE CODES	4
INTENDED AREA OF USE	4
TECHNICAL DATA	4
STANDARDS	5
WIRING AND CONNECTIONS	5
OPERATIONAL DIAGRAMS	6
MOUNTING INSTRUCTIONS IN STEPS	8
VERIFICATION OF INSTALLATION INSTRUCTIONS	10
OPERATING INSTRUCTIONS	11
MODBUS REGISTER MAPS	12
TRANSPORT AND STORAGE	17
WARRANTY AND RESTRICTIONS	17
MAINTENANCE	17

SAFETY AND PRECAUTIONS



Read all the information, the datasheet, mounting and operating instructions and study the wiring and connection diagram before working with the product. For personal and equipment safety, and for optimum product performance, make sure you entirely understand the contents before installing, using, or maintaining this product.



For safety and licensing (CE) reasons, unauthorised conversion and /or modifications of the product are inadmissible.



The product should not be exposed to abnormal conditions, such as: extreme temperatures, direct sunlight or vibrations. Long-term exposure to chemical vapours in high concentration can affect the product performance. Make sure the work environment is as dry as possible; avoid condensation.



All installations shall comply with local health and safety regulations and local electrical standards and approved codes. This product can only be installed by an engineer or a technician who has expert knowledge of the product and safety precautions.



Avoid contacts with energised electrical parts. Always disconnect the power supply before connecting, servicing or repairing the product.



Always verify that you apply appropriate power supply to the product and use appropriate wire size and characteristics. Make sure that all the screws and nuts are well tightened and fuses (if any) are fitted well.



Recycling of equipment and packaging should be taken into consideration and these should be disposed of in accordance with local and national legislation / regulations.



In case there are any questions that are not answered, please contact our technical support or consult a professional.

PRODUCT DESCRIPTION

The EVS-1-XX-DM is an electronic fan speed controller intended for single-phase voltage controllable electric motors. It features with Modbus RTU communication and provides a wide range of functionalities: remote control options, adjustable off level, min. and max. output voltage settings, and time-limited motor operation initiated by a logic or switch signal.

ARTICLE CODES

Code	Nominal current [A]	Fuse rating [A]
EVS-1-15-DM	1,5	F 3,15 A H 250 VAC
EVS-1-30-DM	3,0	F 5,0 A H 250 VAC
EVS-1-60-DM	6,0	F 10,0 A H 250 VAC
EVS-1100-DM	10,0	F 16,0 A H 250 VAC

INTENDED AREA OF USE

- Fan speed control in ventilation systems
- Applications where Modbus communication or a timer function is needed
- For indoor use only

TECHNICAL DATA

- Power supply: 230 VAC \pm 10 % / 50–60 Hz
- Analog input:
 - ▶ voltage: 0–10 VDC / 10–0 VDC
 - ▶ current: 0–20 mA / 20–0 mA
- Analog input modes: ascending or descending
- Analog input functionality: Normal mode / Logic mode
- Remote control input: normal or timer functionality
- Regulated output: 30–100 % U_s
- Max. output load: depends on the version
- Unregulated output, L1: 230 VAC (50 / 60 Hz) / max. 2 A
- Min. output voltage setting, U_{min} : 30–70 % U_s (69–161 VAC), selectable by trimmer or via Modbus
- Max. output voltage setting, U_{max} : 75–100 % U_s (175–230 VAC), selectable by trimmer or via Modbus
- Off level, adjustable by trimmer:
 - ▶ 0–4 VDC / 0–8 mA for ascending mode
 - ▶ 10–6 VDC / 20–12 mA for descending mode
- Kick start or soft start
- Low voltage supply output: + 12 VDC / 1 mA for external potentiometer
- Modbus communication
- Operating indication:
 - ▶ continuous green: normal operation
 - ▶ blinking green: stand-by

- Overvoltage and overcurrent protection
- Enclosure:
 - ▶ plastic R-ABS, UL94-V0
 - ▶ grey colour (RAL 7035)
- Protection standard: IP54 (according to EN 60529)
- Operating ambient conditions:
 - ▶ temperature: - 20—40 °C
 - ▶ rel. humidity: < 95 % rH (non-condensing)
- Storage temperature: -40—50 °C

STANDARDS

- Low Voltage Directive 2006/95/EC
- EMC Directive 2004/108/EC: EN 61326
- WEEE Directive 2012/19/EU
- RoHs Directive 2011/65/EU



WIRING AND CONNECTIONS

L	Mains supply 230 VAC ±10 % - 50—60 Hz
N	Neutral
PE	Earth terminal
L1	Unregulated output (230 VAC / max. 2 A)
U1, U2	Regulated output to the motor
SW	Remote / timer switch
A	Modbus RTU (RS485) signal A
/B	Modbus RTU (RS485) signal /B
+V	Supply output + 12 VDC / 1 mA
Ai	Analog input: (0—10 VDC / 0—20 mA) or (10—0 VDC / 20—0 mA) Logic input (Timer functionality): (min. 2,5 VDC and > 30 ms)
GND	Ground
Connections	Cable cross section: max. 2,5 mm ² Cable gland clamping range: 3—6 mm / 5—10 mm

OPERATIONAL DIAGRAMS

Normal / Remote operating modes

Ascending input mode

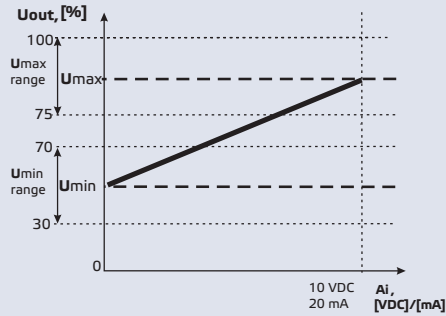

Ascending mode calculation formula

$$U_{out} = U_{min} + \frac{A_i}{A_{i_{max}}} (U_{max} - U_{min})$$

Descending input mode

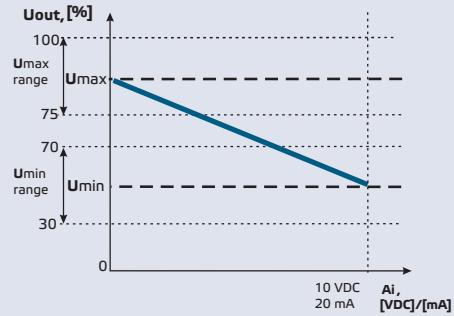

Descending mode calculation formula

$$U_{out} = U_{max} - \frac{A_i}{A_{i_{max}}} (U_{max} - U_{min})$$

Off level disabled

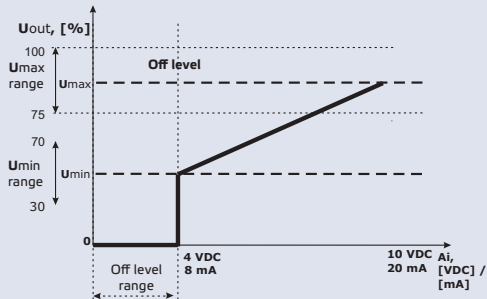

Ascending mode calculation formula

$$U_{out} = U_{max} + \frac{A_i - \text{Off level}}{A_{i_{max}} - \text{Off level}} (U_{min} - U_{max})$$

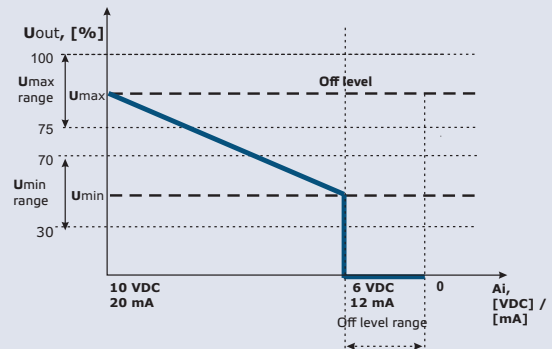

Descending mode calculation formula

$$U_{out} = U_{max} - \frac{A_i - \text{Off level}}{A_{i_{max}} - \text{Off level}} (U_{min} - U_{max})$$

Off level enabled

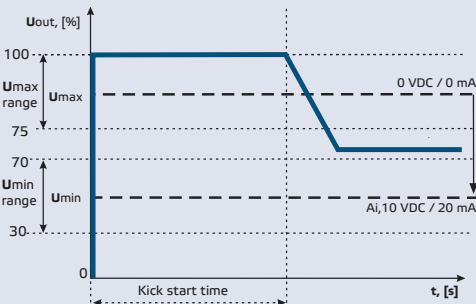
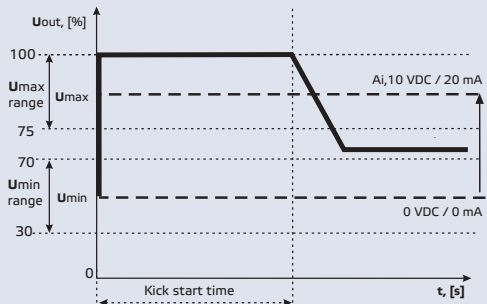

Kick start enabled

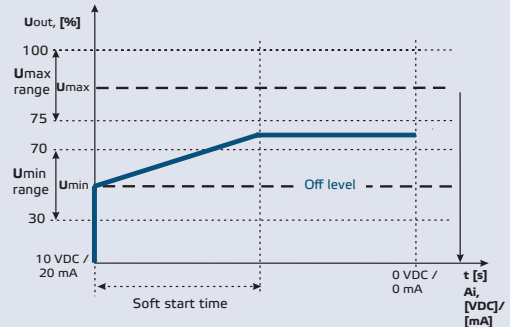
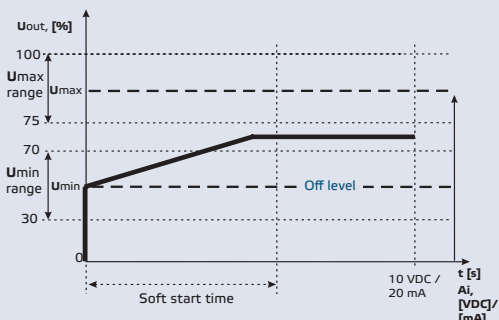

Soft start enabled

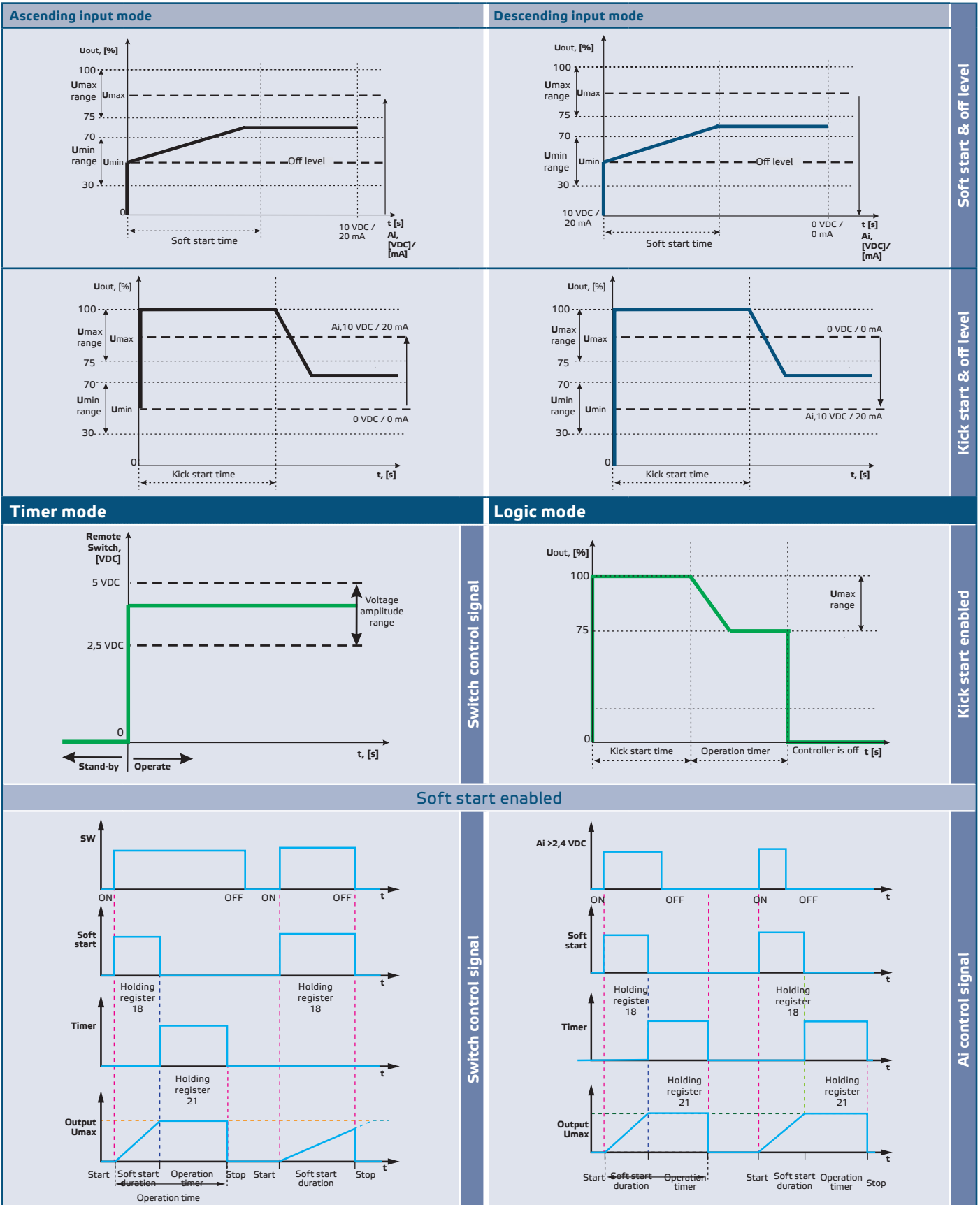

MOUNTING INSTRUCTIONS IN STEPS

Before you start mounting the EVS controller read carefully “*Safety and Precautions*”. Choose a smooth surface for installation (a wall, panel and etc.). Follow these steps:

1. Switch off the power supply
2. Open the enclosure cover and fix the unit to the wall or panel using the provided dowels and screws. Mind the correct mounting position and unit dimensions. (See **Fig. 1** *Mounting position* and **Fig. 2** *Mounting dimensions*.)

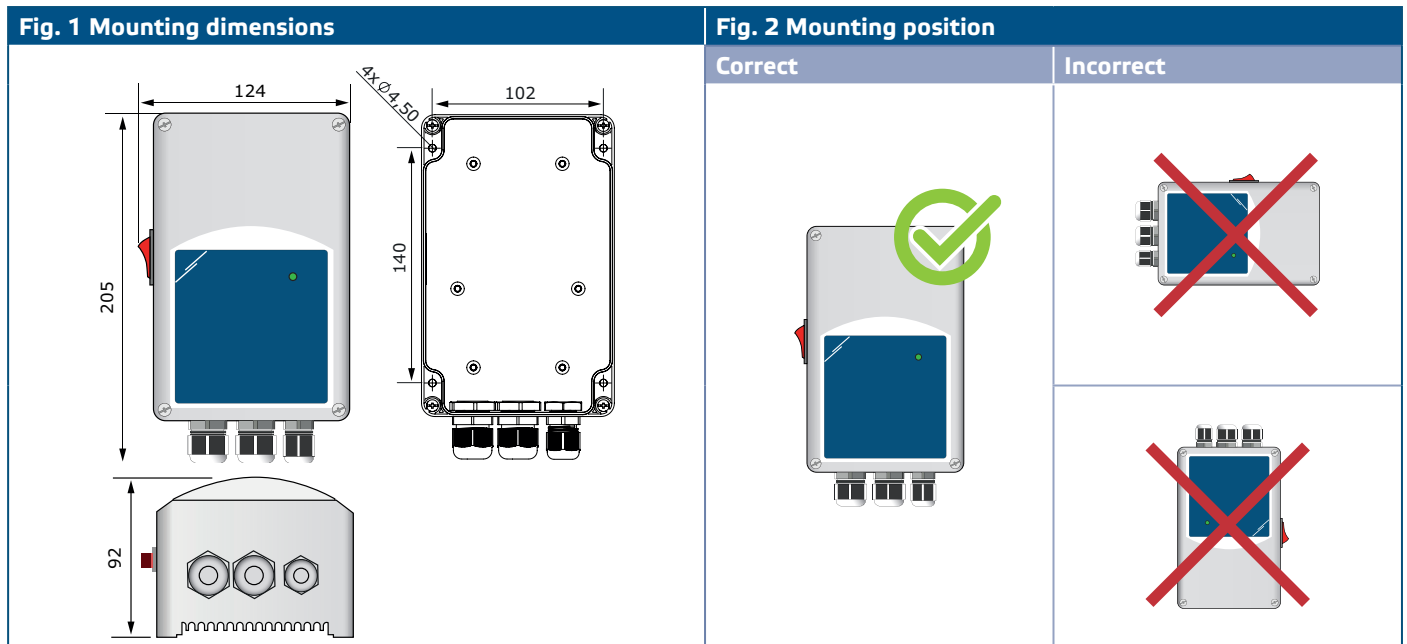

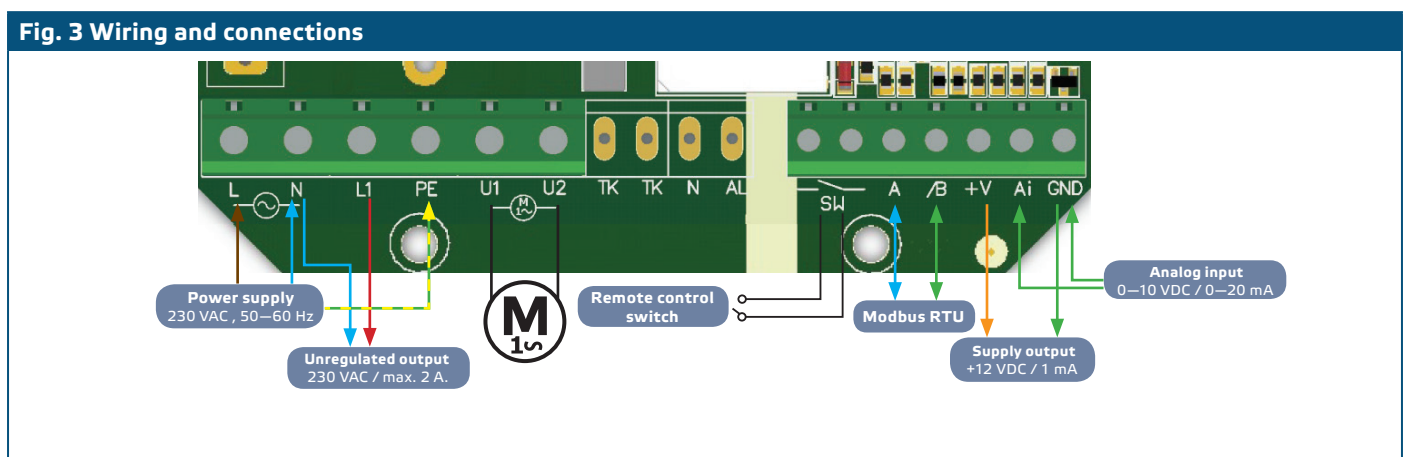

3. Connect the motor / fan.
4. Connect L1 output for a 3-wire connection, controlled valve, etc. (if necessary). See **Fig. 3**.

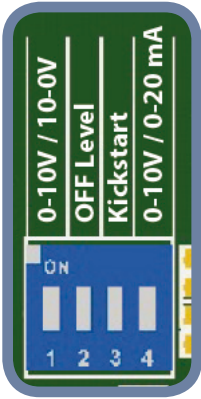

5. Select the required analog input type and mode, start mode and OFF level mode by the DIP switch on the board. (See **Fig. 4** *DIP switch settings*.)

Fig. 4 DIP switch settings

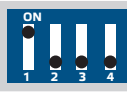
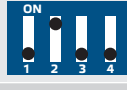
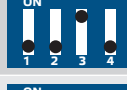

Ascending / descending mode selection (DIP switch, position 1)		ON - Descending mode: 10—0 VDC / 20—0 mA OFF - Ascending mode: 0—10 VDC / 0—20 mA
OFF level selection (DIP switch, position 2)		ON - enabled OFF - disabled
Kick start / soft start selection (DIP switch, position 3)		ON - Kick start OFF - Soft start
Input mode selection (DIP switch, position 4)		ON - Current mode (0—20 mA) OFF - Voltage mode (0—10 VDC)

6. The Network Bus Terminator (NBT) is used to set the device as an end device and by default the NBT is disconnected. It is put manually onto the pins to be connected (see **Fig. 5**). To assure correct communication, the NBT jumper needs to be activated in only two devices on the Modbus RTU network (see **Example 1** and **Example 2**).

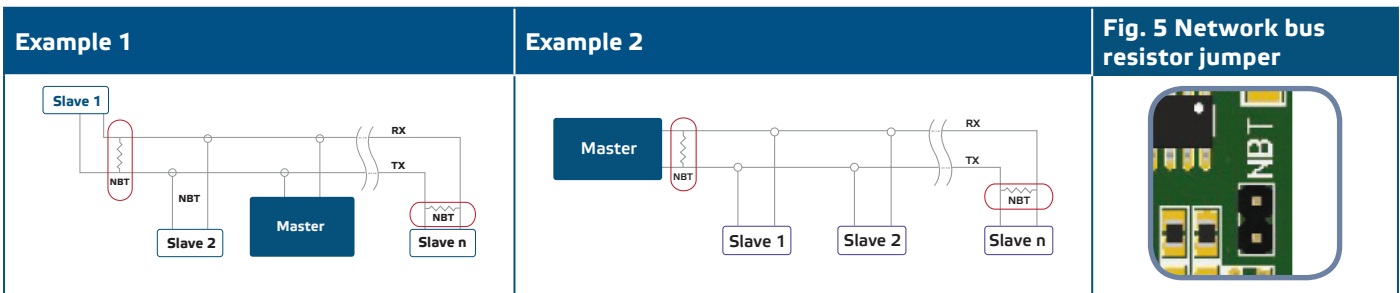

ATTENTION

On a Modbus RTU network, two bus terminators (NBTs) need to be activated

ATTENTION

If an AC power supply is used with any of the units on a Modbus network, the GND terminal should NOT BE CONNECTED to other units on the network or via the CNVT-USB-RS485 converter. This may cause permanent damage to the communication semiconductors and / or the computer!

7. Connect the power supply cable.
8. Adjust the max. speed by trimmer (if necessary). The default setting is Us (230 VAC). See **Fig. 6** *Max. speed trimmer*.
9. Adjust the min. speed by trimmer (if necessary). The default setting is 30 % Us (69 VAC). See **Fig. 7** *Min. speed trimmer*.
10. Adjust the OFF level value by trimmer (if necessary). The default setting is 0 VAC. See **Fig. 8** *Off level trimmer*.

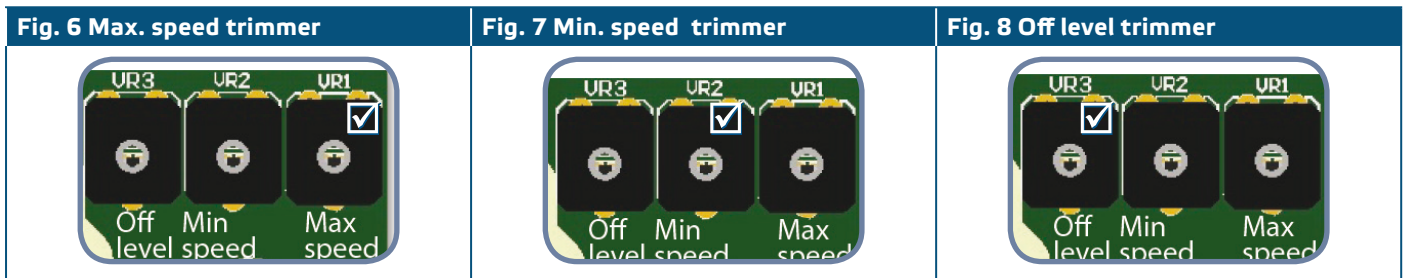

11. Close the enclosure and fix the cover.
12. Switch on the power supply.
13. Customise the factory settings to the desired ones, through 3SModbus software (if necessary). For the default factory settings see **Table Modbus register maps**.

VERIFICATION OF INSTALLATION INSTRUCTIONS

Follow the instructions below:

1. Switch on the mains supply.
2. Set the NBT jumper, DIP switch, Max. trimmer, Min. trimmer and OFF level trimmer to desired positions / values. The factory settings are as follows:
 - ▶ NBT jumper is open (Network bus termination resistor is disconnected);
 - ▶ Ascending mode: 0–10 VDC / 0–20 mA
 - ▶ Off level - OFF;
 - ▶ Kick start disabled;
 - ▶ Input voltage mode (0–10 VDC);
 - ▶ Min. setting of the Min. speed trimmer
 - ▶ Max. setting of the Max. speed trimmer;
 - ▶ Min. setting of the Off level trimmer.
3. Set the analog input signal to the maximum value of 10 VDC or 20 mA.
4. The connected motor will run at maximum speed or minimum speed depending on the analog input mode (ascending / descending).
5. If OFF level is enabled and descending analog input mode is selected, the motor will stop running.
6. Set the analog input signal to the maximum value of 0 VDC or 0 mA.
7. The connected fan will run at minimum speed or maximum speed depending on the analog input mode (ascending / descending).
8. If OFF level is enabled and ascending analog input mode is selected, the motor will stop running.
9. If OFF level is enabled and the input signal is equal to the value of the OFF level, the speed of the motor will be the minimum speed in ascending mode or the maximum speed in descending mode.
10. If the controller does not work according to the instructions above, the wiring connections and settings need to be checked.
11. Check if both LEDs (**Fig. 9**) blink after you switch on your unit. If they do, your unit has detected Modbus network. If they do not, check the connections again.

Fig. 9 Communication detection indication

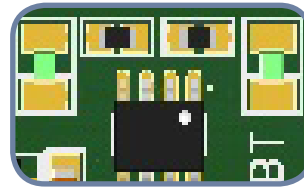

ATTENTION

The status of the LEDs can be checked only when the unit is energised. Take the relevant safety measures!

OPERATING INSTRUCTIONS

OPERATION MODES

In Modbus mode you control the parameters: Umax, Umin, Kick start / Soft start, Off level enable / disable and Off level value through Modbus registers.

In Standalone mode you control the parameters: Umax, Umin, Kick start / Soft start, Off level enable / disable and Off level value by means of the hardware settings (DIP switch, trimmers, jumpers).

In Normal mode if Off level is disabled, Softstart / Kickstart is executed only once - after the controller is supplied; otherwise Softstart / Kickstart is executed every time the controller is switched on.

When **Timer mode** is selected, the controller receives a pulse control signal from the remote control switch. When **Logic mode** is selected, the controller receives a pulse control signal from the Ai input.

In both modes **Timer mode** and **Logic mode** the pulse width is to be more than 30 ms; otherwise the signal is filtered.

FRONT PANEL LED INDICATION

When the green LED on the front cover (**Fig. 10**) gives out a continuous light, the controller operates in normal mode. When it blinks:

- ▶ the controller operates in remote control mode, or
- ▶ OFF level is enabled and the analog input signal is below the OFF level value.

Fig. 10 Operation indication



MODBUS REGISTER MAPS

INPUT REGISTERS					
		Data type	Description	Data	Values
1	Analog input level	unsigned int.	Analog input value depending on the selected analog input type.	0–100	0 = 0 VDC 100 = 10,0 VDC or 0 = 0 mA 100 = 20,0 mA
2	Current output voltage	unsigned int.	Actual output voltage	0 30–100	0 = 0 % Us 30 = 30 % Us 100 = 100 % Us
3	Analog input type	unsigned int.	Type of the selected analog input	0–1	0 = 0–20 mA 1 = 0–10 VDC
4	Ascending / descending input mode	unsigned int.	Ascending or descending analog input mode depending on the selected analog input type.	0–1	0 = 10–0 VDC 1 = 0–10 VDC or 0 = 20–0 mA 1 = 0–20 mA
5	Maximum output voltage	unsigned int.	Maximum output voltage	75–100	75 = 75 % Us 100 = 100 % Us
6	Minimum output voltage	unsigned int.	Minimum output voltage	30–70	30 = 30 % Us 70 = 70 % Us
7	Enable off level	unsigned int.	Enables off level	0–1	0 = Disabled 1 = Enabled
8	Off level value	unsigned int.	Off level value depending on the selected analog input type and ascending / descending analog input mode.	0– 40 60–100	Ascending mode: Voltage 0 = 0 VDC 400 = 4,0 VDC Current 0 = 0 mA 200 = 8,0 mA Descending mode: Voltage 100 = 10,0 VDC 60 = 6,0 VDC Current 100 = 20,0 mA 60 = 12,0 mA
9	Kick start / soft start	unsigned int.	Selects kick start or soft start	0–1	0 = soft start 1 = kick start
10	Remote control input	unsigned int.	Remote control input	0–1	0 = Disabled 1 = Enabled
12	L1 control	unsigned int.	L1 control	0–1	0 = Off 1 = On
14	ON/Stand-by LED	unsigned int.	ON/Stand-by LED	0–2	0 = Off 1 = On 2 = Stand-by
15-20			Reserved, returns 0		

HOLDING REGISTERS						
		Data type	Description	Data	Default	Values
1	Device slave address	unsigned int.	Modbus device address	1–247	1	
2	Modbus baud rate	unsigned int.	Modbus communication baud rate	1–4	2	1 = 9.600 2 = 19.200 3 = 38.400 4 = 57.600
3	Modbus parity	unsigned int.	Parity check mode	0–2	1	0 = 8N1 1 = 8E1 2 = 8O1
4	Device type	unsigned int.	Device type (<i>Read only</i>)	EVSX-DM = 3005		
5	HW version	unsigned int.	Hardware version of the device (<i>Read only</i>)	XXXX		0x0300 = HW version 3.00
6	FW version	unsigned int.	Firmware version of the device (<i>Read only</i>)	XXXX		0x0150 = FW version 1.50
7	Operating mode	unsigned int.	Enables Modbus control and disables the DIP switch and trimmers	0–1	0	0 = Standalone mode 1 = Modbus mode
8	Output override	unsigned int.	Enables the direct control over the output. <i>Always settable. Active only if holding register 7 is set to 1.</i>	0–1	0	0 = Disabled 1 = Enabled
9-10			Reserved, returns 0			
11	Analog input type	unsigned int.	Selects the analog input type of the device. <i>Always settable. Active only if holding register 7 is set to 1.</i>	0–1	1	0 = 0–20 mA 1 = 0–10 VDC
12	Ascending / descending analog input mode	unsigned int.	Ascending / descending analog input mode. <i>Depends on the selected analog input type. Always settable. Active only if holding register 7 is set to 1.</i>	0–1	1	0 = 10–0 VDC 1 = 0–10 VDC or 0 = 20–0 mA 1 = 0–20 mA
13	Maximum output voltage	unsigned int.	Maximum settable output voltage. <i>Always settable. Active only if holding register 7 is set to 1.</i>	75–100	100	75 = 75 % Us 100 = 100 % Us
14	Minimum output voltage	unsigned int.	Minimum settable output voltage. <i>Always settable. Active only if holding register 7 is set to 1.</i>	30–70	30	30 = 30 % Us 160 = 00 % Us
15	Enable off level	unsigned int.	Enables off level. <i>Always settable. Active only if holding register 7 is set to 1.</i>	0–1	0	0 = Disabled 1 = Enabled
16	Off level value	unsigned int.	Off level value. <i>Depends on the selected analog input type and ascending / descending analog input mode. Always settable. Active only if holding register 7 is set to 1.</i>	0–40 60–100	0	Ascending mode: Voltage 0 = 0 VDC 40 = 4,0 VDC Current 0 = 0 mA 40 = 8,0 mA Descending mode: Voltage 100 = 10,0 VDC 60 = 6,0 VDC Current 100 = 20,0 mA 60 = 12,0 mA
17	Kick start / soft start	unsigned int.	Selects kick start or soft start. <i>Always settable. Active only if holding register 7 is set to 1.</i>	0–1	1	0 = Soft start 1 = Kick start
18	Kick start / soft start duration	unsigned int.	Sets the duration time. <i>Always settable. Active only if holding register 7 is set to 1.</i>	0–60	10	0 = 0 s 60 = 60 s
19	Remote control functionality	unsigned int.	Sets the remote control input mode. <i>Depends on the selected kick start or soft start mode. Always settable. Active only if holding register 7 is set to 1.</i>	0–1	0	0 = Normal mode 1 = Timer mode
20	Analog input functionality	unsigned int.	Sets the analog input functionality. <i>Depends on the selected kick start or soft start. Always settable. Active only if holding register 7 is set to 1.</i>	0–1	0	0 = Normal mode 1 = Logic mode
21	Operation timer	unsigned i nt.	Sets the operation time of the device when Timer mode by remote control input or Logic mode by the analog input is selected. The operation time is additional to the kick start / soft start duration times. <i>Always settable. Active only if holding registers 7 and 19 or / and 20 are set to 1.</i>	0–200	60	0 = 0 s 200 = 200 s
22-30			Reserved, returns 0			
31	Output override value	unsigned int.	Override value for the analog output. <i>Always settable. Active only if holding register 8 is set to 1.</i>	0 30–100	0	0 = 0 % Us 30 = 30 % Us 100 = 100 % Us
32-40			Reserved, returns 0			

If you want to find out more about Modbus over serial line, please visit: http://www.modbus.org/docs/Modbus_over_serial_line_V1_02.pdf

INPUT REGISTERS (See **Table 1** Modbus register maps)

The input registers are read-only. **Table 1** shows how the data is organized in the input register sector. The measured data starts from address 1 (30001) and ends at address 14 (30014). The other input registers are not used. When they are addressed, they return '0'.

All the data can be read by "Read Inputs Registers" command. **Table 1** shows what the type of the returned data for each register is and the way it should be interpreted. For example reading '300' in input register 1 means that the measured analog input signal is 3,0 VDC (or 6,0 mA), reading '50' in input register 2 means that the output voltage is 50 % Us (115 VAC).

- **Input register 1** (30001) shows the current value of measured analog input signal. This value depends on the selected analog input type. When voltage input is selected, the values vary in the range of 0–1.000 (0–10,0 VDC). When current input is selected, the values vary in the range of 0–1.000 (0–20,0 mA).
- **Input register 2** (30002) shows the current value of the output voltage. This input register is overridden by holding register 31 if output override control (holding register 8) is enabled. When output override control is disabled, this input register shows the value of the output voltage according to the selected operating mode. The output voltage values vary in the range of 30–100 % Us (69–230 VAC). Reading '0' (0 VAC) indicates that the controller is off.
- **Input register 3** (30003) shows the type of the analog input signal. This input register is defined by holding register 11 or by the hardware setting of position 4 of the DIP switch. The values are '0' (for 0–20 mA) or '1' (for 0–10 VDC)
- **Input register 4** (30004) shows the selected mode of the analog input. This input register is defined by holding register 12 or the hardware setting of position 1 of the DIP switch (**Fig. 4**), according to the selected operating mode. The values are '0' (for descending mode) or '1' (for ascending mode).
- **Input register 5** (30005) shows the value of the maximum output voltage. This input register is defined by holding register 13 or the hardware setting of the Max. trimmer (**Fig. 6**), according to the selected operating mode. The register values are in range of 75–100 (75– 100 % Us VAC).
- **Input register 6** (30006) shows the value of the minimum output voltage. This input register is defined by holding register 14 or the hardware setting of Min. trimmer (**Fig. 7**), according to the selected operating mode. The register values are in range 30–70 % Us.
- **Input Register 7** (30007) gives information about the OFF level state. In Standalone mode it contains the value set by position 2 of the DIP switch (**Fig. 4**). In Modbus mode it contains the value of holding register 15. It could be '0' (disabled) or '1' (enabled).
- **Input Register 8** (30008) gives information about the OFF level value. In Standalone mode it contains the value set by the OFF level trimmer (**Fig. 8**). In Modbus mode it contains the value set by holding register 16. This value depends on the selected analog input type and mode. The register values can vary from 0 to 40 (0– 4,0 VDC / 0–8,0 mA) and from 60 to 100 (6,0–10,0 VDC / 12,0– 20,0 mA). The values depend on the selected analog input type and mode.
- **Input Register 9** (30009) gives information about the kick start or soft start selection. In Standalone mode the value corresponds to the start type set by position 3 of the DIP switch. In Modbus mode it contains the value set by holding register 17. The register values are '0' (for soft start) or '1' (for kick start).
- **Input Register 10** (30010) shows the state of the remote control input. When it is disabled, the unit works in normal operating mode. When the remote control input is enabled, the controller is in stand-by mode. The register values are '0' (for disabled) or '1' (for enabled).
- **Input Register 12** (30012) shows the status of the unregulated output L1. When the analog input signal is below the value of the OFF level (if enabled) or when the

remote control input is disabled, the output voltage of the unregulated output L1 is '0' = OFF (0 VAC). Otherwise it is '1' = On (230 VAC)

- **Input Register 14** (30014) shows the operating status of the unit. When the register value is '0' (Off), the controller is switched off. The ON/Stand-by LED on the front panel is off. See **Fig. 10 Operating indication**.

When the value is '1' (On), the controller operates according to the control algorithm, and the analog input signal is above the selected OFF level value (if enabled). The ON/Stand-by LED (**Fig. 10**) gives out continuous light.

The ON / Stand-by LED blinks and the register value is 2 (Stand-by) when OFF level is enabled and the analog input signal is below the OFF level value.

HOLDING REGISTERS (See **Table 1 Modbus register maps**)

These registers are read / write registers and they can be managed with "Read Holding Registers" command, "Write single register" and "Write Multiple Registers" commands. They are organised in parts containing different kind of information. The registers that are not used are read only. Writing on these registers does not return Modbus error exception; however, it does not change anything either!

Part 1:

This part contains information about the unit and Modbus communication settings.

- **Holding register 1** (40001) contains the address at which the controller replies to the Modbus master unit. The default address is '1'. You can change it in two ways:
 1. Send command "Write Single Register" with address '1' and write the new address value.
 2. Connect only your unit to a master controller or PC application and send the command "Write Single Register" to address '0' (Modbus broadcast address) and write a new address value.
- **The next two registers (2 and 3)** contain Modbus settings. Changing these registers you change the communication settings. The default Modbus settings are 19200-E-1 as it is stated in the *Modbus Protocol Specification*.
- **The next three registers (4, 5 and 6)** are read only. They contain information about the hardware and firmware versions.
- **Holding register 7** (40007) sets the operation mode of the controller. There are two options: Standalone mode and Modbus mode. In Standalone mode the controller is fully controlled by the analog input signal and the selected hardware settings. In Modbus mode the settings can be controlled by the Modbus master controller.
- **Holding register 8** (40008) is used for output override control. The setting is used to override the output voltage by a preselected value. This value has greater priority over the calculated output voltage of the integrated control algorithm. Only kick start / soft start can change the output voltage value.
- **Holding registers 9** (40009) and **10** (40010) are not used. They are read only.

Part 2:

- **Holding register 11** (40011) sets the analog input signal type. The default value is '1' (0–10 VDC). '0' is for 0–20 mA.

- **Holding register 12 (40012)** defines the ascending / descending analog input mode. The default value is '1' is for 0–10 VDC (ascending voltage signal). The register values are '0' for 10–0 VDC and '1' for 0–10 VDC when voltage signal is selected, and '0' for 20–0 mA and '1' for 0–20 mA when current signal is selected
- **Holding register 13 (40013)** contains the maximum output voltage. The default value is '100' (100 % Us or 230 VAC). The register values vary in the range of 75–100 (75–100 % Us).
- **Holding register 14 (40014)** contains the minimum output voltage. The default value is '30' (30 % Us). The register values vary in the range of 30–70 (30–70 % Us).
- **Holding register 15 (40015)** sets the OFF level state. The default value is '0' (disabled). '1' is for enabled.
- **Holding register 16 (40016)** defines the OFF level. The default value is '0' (0 VDC). This value depends on the selected analog input type and mode. The register values vary in the ranges of 0–40 (0–4,0 VDC) for ascending voltage signal and 60–100 (6,0–10,0 VDC) for descending voltage signal. When current signal is selected, the register values are in ranges of 0–40 (0–8,0 mA) for ascending signal and 60–100 (12,0–20,0 mA) for descending signal.
- **Holding register 17 (40017)** sets kick start or soft start. The default value is '1' (kick start). '0' value is for soft start
- **Holding register 18 (40018)** contains kick start or soft start duration time. The default value is '10' (10 seconds). The register values vary from '0' to '60' (0–60 seconds). This setting is accessible only in Modbus mode.
- **Holding register 19 (40019)** selects the remote control input functionality. The default value is '0' for normal mode. Value '1' is for timer mode. This setting is accessible only in Modbus mode. OFF level mode is not used in timer mode.
- **Holding register 20 (40020)** selects the analog input functionality. The default value is '0' for normal mode; '1' is for logic mode. This setting is accessible only in Modbus mode.
- **Holding register 21 (40021)** sets the value of the operation timer. This holding register is accessible only in timer mode and / or logic mode. The default value is '60' (60 seconds). The register values can vary from 0 to 200 (0–200 seconds). This setting is accessible only in Modbus mode. The working time is equal to the sum of the kick start / soft start duration time and the time value of the operation timer. When a working time expires, only a remote control input or analog input can restart the unit.
- **The next holding registers 22 (40022)–30 (40030)** are not used. They are read only.
- **Holding register 31 (40031)** overrides the output voltage value in Modbus mode when output override is enabled. The override value setting does not depend on the other settings except on the kick start or soft start selection. The default value is '0' (VAC). The register value can vary in the range of 30–100 (30–100 % Us). It can be also '0' (0 % Us).
- **The next holding registers 32 (40032)–40 (40040)** are not used. They are read only

TRANSPORT AND STORAGE

Avoid shocks and extreme conditions; stock in original packing.

WARRANTY AND RESTRICTIONS

Two years from the delivery date against defects in manufacturing. Any modifications or alterations to the product after the date of publication relieve the manufacturer of any responsibilities. The manufacturer bears no responsibility for any misprints or mistakes in this data.

MAINTENANCE

In normal conditions this product is maintenance-free. If soiled, clean with a dry or damp cloth. In case of heavy pollution, clean with a non-aggressive product. In these circumstances the unit should be disconnected from the supply. Pay attention that no fluids enter the unit. Only reconnect it to the supply when it is completely dry.