

Data sheet | Item number: 221-500

Mounting carrier; 221 Series - 4 mm²; for DIN-35 rail mounting/screw mounting; orange

www.wago.com/221-500

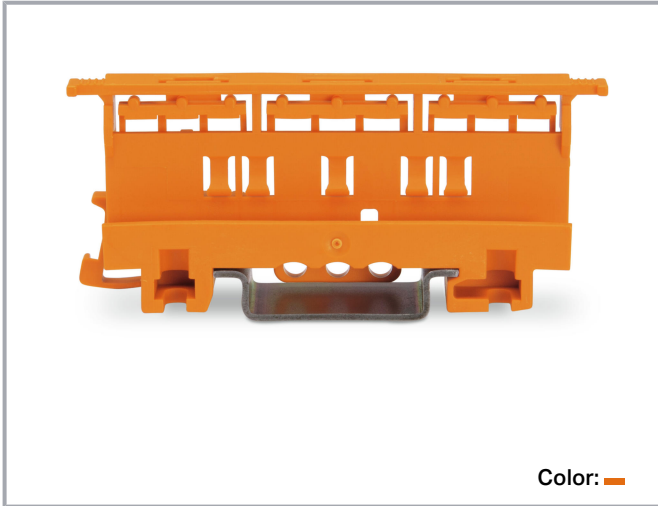

Color: 

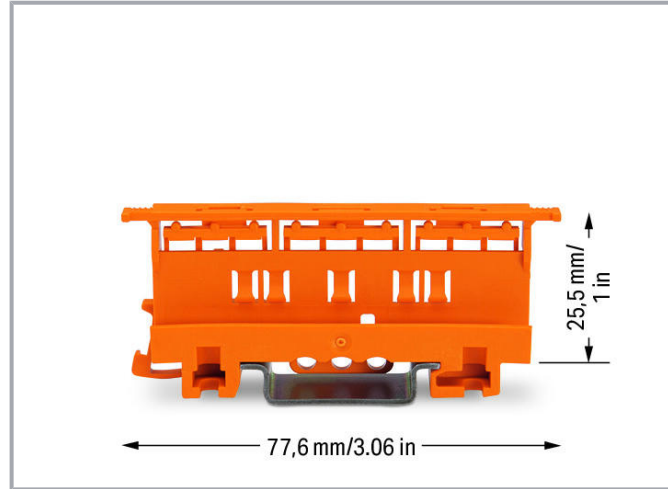

Data

Physical data

Width	17.5 mm / 0.689 inch
Height	77.6 mm / 3.055 inch
Depth from upper edge of DIN-rail	25.5 mm / 1.004 inch

Mechanical data

Mounting type	DIN-35 rail Screw mount
Suitable	for 2-, 3- and 5-conductor 221 Series Splicing Connectors (4 mm ²)

Material data

Note on material data	Information on material data can be found here
Color	orange
Insulation material	Polyamide (PA66)
Flammability class per UL94	V0
Weight	9.6 g

Subject to changes. Please also observe the further product documentation!

WAGO GmbH & Co. KG
Hansastr. 27
32423 Minden
Phone: +49571 887-0 | Fax: +49571 887-169
Email: info.de@wago.com | Web: www.wago.com

Do you have any questions about our products?
We are always happy to take your call at +49 (571) 887-44222.

Commercial data

PU (SPU)	50 (10) Stück
Packaging type	box
Country of origin	CN
GTIN	4055143421942
Customs tariff number	39269097900

Optional accessories

Marking accessories

Marking strip



Item no.: 210-833

Marking strips; 25 m on roll; 6 mm wide; plain; Self-adhesive; white

www.wago.com/210-833

Mounting adapter

Mounting accessories



Item no.: 222-505

Strain relief plate; for mounting carrier; 221 or 222 Series, can be snapped

www.wago.com/222-505



Item no.: 222-510

Angled DIN-rail adapter; in combination with mounting carrier; 221-500 or 222-500; for DIN-35 rail mounting; gray

www.wago.com/222-510

Downloads

Documentation

Bid Text

221-500 X81 - Datei	19-Feb-2019	xml 2.8 kB	Download
221-500 docx - Datei	23-Jan-2019	docx 14.9 kB	Download
ausschreiben.de 221-500		URL	Download

Additional Information

Technical explanations		pdf 2.2 MB	Download
------------------------	--	---------------	----------

Subject to changes. Please also observe the further product documentation!

WAGO GmbH & Co. KG
 Hansastr. 27
 32423 Minden
 Phone: +49571 887-0 | Fax: +49571 887-169
 Email: info.de@wago.com | Web: www.wago.com

Do you have any questions about our products?
 We are always happy to take your call at +49 (571) 887-44222.

CAD/CAE-Data

CAD data

2D/3D Models 221-500	URL	Download
----------------------	-----	----------

CAE data

EPLAN Data Portal 221-500	URL	Download
---------------------------	-----	----------

ZUKEN Portal 221-500	URL	Download
----------------------	-----	----------

Environmental Product Compliance

Compliance Search

Environmental Product Compliance 221-500	URL	Download
--	-----	----------

Mounting carrier; 221 Series - 4 mm²; for DIN-35 rail mounting/screw mounting; orange

Installation Notes

Conductor termination

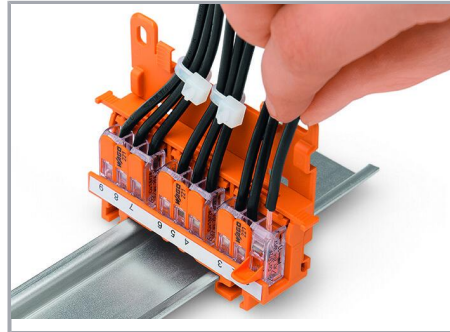
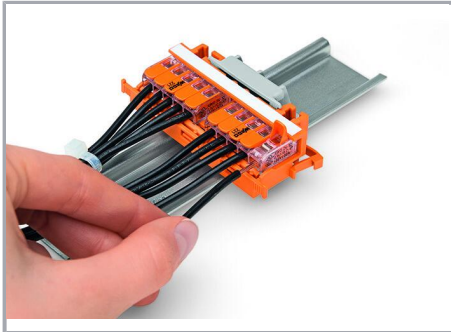

CAGE CLAMP® connection:

Removing a conductor.

Conductor termination with connectors fitted in a mounting carrier

Subject to changes. Please also observe the further product documentation!



Inserting a connector into the mounting carrier.



Inserting a connector into the mounting carrier.



Removing a connector from the mounting carrier.



Securing a strain relief plate (222-505) to the mounting carrier.



Snapping the angled DIN-rail adapter (222-510) onto the mounting carrier.

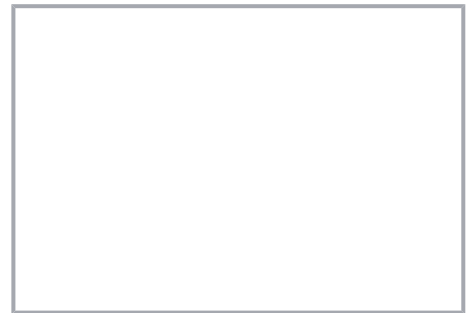

Horizontal mounting on DIN-35 rail using an angled DIN-rail adapter

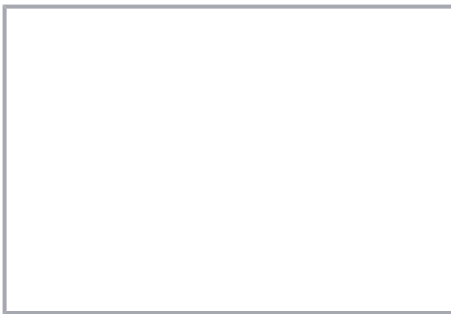

Horizontal mounting on DIN-35 rail using an angled DIN-rail adapter

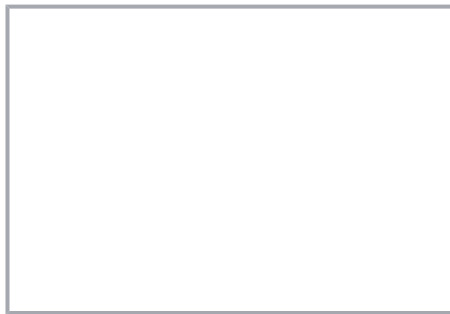

Horizontal screw mounting with strain relief plate on a flat surface

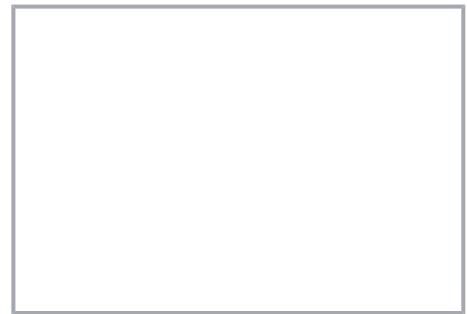

Vertical mounting with strain relief plate on DIN-35 rail

Subject to changes. Please also observe the further product documentation!



Strain relief via cable ties on the mounting carrier (transverse to the connectors' wiring direction) – clamping units labeled via marking strips (210-334)



Vertical screw mounting with strain relief plate on a flat surface



Mounting carrier on a DIN-35 rail

Testing

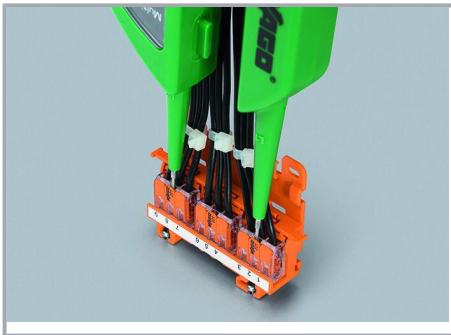

Testing connectors via test slots on top of the carrier.

Subject to changes. Please also observe the further product documentation!