



DIRIS A10

Multifunction meters - MFM
Modular multifunction meter

Metering, monitoring
& power quality



DIRIS A10

diris_791_c_1_cat

The solution for

- > Industry.
- > Infrastructures.
- > Data centres.



Strong points

- > Easy to use.
- > Integrated temperature sensor.
- > Detects wiring errors.
- > Compliant with IEC 61557-12.

Conformity to standards

- > IEC 61557-12
- > IEC 62053-22 class 0.5S
- > IEC 62053-23 class 2



Function

The **DIRIS A10** is a modular multifunction meter for measuring electrical values in low voltage networks. It allows all electrical parameters to be displayed and utilised for communication and/or output functions.

Advantages

Easy to use

Five direct access pushbuttons enable all measurements to be clearly viewed on its backlit LCD display.

Integrated temperature sensor

It allows variations in temperature to be detected.

Detects wiring errors

An integrated test function can be utilised to detect incorrect wiring and to automatically correct CT installation errors.

Compliant with IEC 61557-12

IEC 61557-12 is a high-level standard for all PMDs (Performance Monitoring Devices) that are designed to measure and monitor electrical parameters in distribution networks. Compliance with IEC 61557-12 ensures a high level of equipment performance, in terms of metrology, and the mechanical and environmental aspects (EMC, temperature, etc.).

Principle diagram

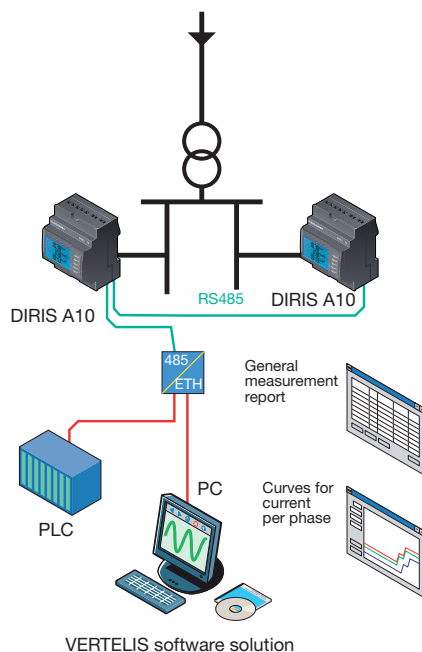

diris_808_L1_gb_cat

Functions

Multi-measurement

- Currents
 - instantaneous: I1, I2, I3, In
 - maximum average: I1, I2, I3, In
- Voltages & frequency
 - instantaneous: V1, V2, V3, U12, U23, U31, F
- Power
 - instantaneous: 3P, ΣP, 3Q, ΣQ, 3S, ΣS
 - maximum average: ΣP, ΣQ, ΣS
- Power factors
 - instantaneous: 3PF, ΣPF

Metering

- Active energy: + kWh
- Reactive energy: + kVarh
- Hours: ⌚

Harmonic analysis

- Total harmonic distortion (level 51)
 - Currents: thd I1, thd I2, thd I3
 - Phase-to-neutral voltage: thd U1, thd U2, thd U3
 - Phase-to-phase voltage: thd U12, thd U23, thd U31

Dual tariff function

Selection of one out of 2 billing tariffs

Events

Alarms on all electrical values

Communications⁽¹⁾

RS485 with MODBUS protocol

Input

Tariff selection
Remote device status

Output

- Remote command of device
- Alarm report
- Pulse report

⁽¹⁾ Available on specific version (see the following pages).

Front panel



Case

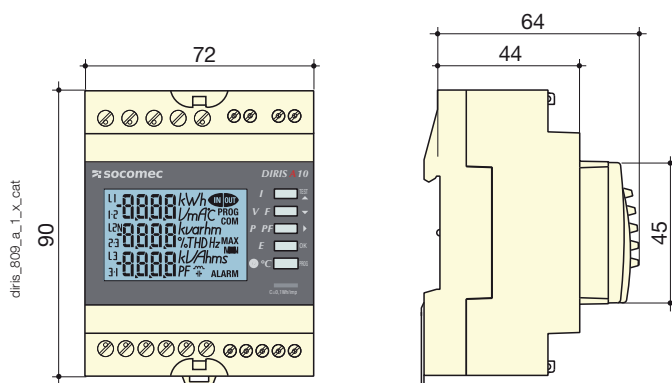

Type	modular
Number of modules	4
Dimensions W x H x D	72 x 90 x 64 mm
Case degree of protection	IP 30
Front degree of protection	IP 52
Display type	backlit LCD display
Voltage and current connection cross-section	4 mm ²
Connection cross-section for AUX supply, input, output and comms.	2.5 mm ²
Weight	205 g (4825 0010) - 215 g (4825 0011)

Electrical characteristics

Current measurement on high-impedance inputs (TRMS)	
Via CT primary	9 999 A
Via CT secondary	5 A
Measurement range	0 ... 11 kA
Input consumption	0.6 VA
Measurement updating period	1 s
Accuracy	0.2 %
Permanent overload	6 A
Intermittent overload	10 I _n for 1 s
Voltage measurements (TRMS)	
Direct measurement between phases	50 ... 500 VAC
Direct measurement between phase and neutral	28 ... 289 VAC
Input consumption	≤ 0.1 VA
Measurement updating period	1 s
Accuracy	0.2 %
Permanent overload	800 VAC
Power measurement	
Measurement updating period	1 s
Accuracy	0.5 %
Power factor measurement	
Measurement updating period	1 s
Accuracy	0.5 %
Frequency measurement	
Measurement range	45 ... 65 Hz
Measurement updating period	1 s
Accuracy	0.1 %

Energy accuracy	
Active (according to IEC 62053-22)	Class 0.5 S
Reactive (according to IEC 62053-23)	Class 2
Auxiliary power supply	
Alternating voltage	110 ... 277 VAC
AC tolerance	± 15 %
Frequency	50 / 60 Hz
Consumption	< 3 VA
Digital output (pulses or on/off)	
Number	1
Type	20 / 30 VDC - 0.5 A - 10 VA
Max. number of operations	≤ 10 ⁹
Input (tariff)	
Number	1
Type	0 VAC: T1 / 200-277 VAC: T2
Communication	
Link	RS485
Type	2 ... 3 half duplex wires
Protocol	MODBUS RTU
MODBUS [®] speed	2400 ... 38400 bauds
Operating conditions	
Operating temperature	- 10 ... + 55 °C
Storage temperature	- 20 ... + 70 °C
Relative humidity	85 %

DIRIS A10

Multifunction meters - MFM
Modular multifunction meter

Connection

Recommendation:

- For IT earthing systems, it is recommended that the CT secondary is not connected to earth.
- When disconnecting the DIRIS, the secondary of each current transformer must be short-circuited. This operation can be carried out automatically by a SOCOMEC PTI, an accessory which is included in this catalogue. Please consult us.
- It is recommended that the earthing point for the DIRIS A10 and the current transformer secondaries are not earthed at the same time.

Low voltage balanced network

3/4 wires with 1 CT

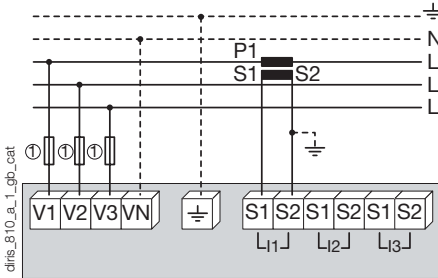

1. Fuses 0.5 A gG / 0.5 A class CC.

Single-phase

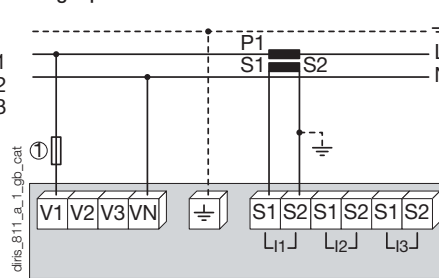

1. Fuses 0.5 A gG / 0.5 A class CC.

Two-phase

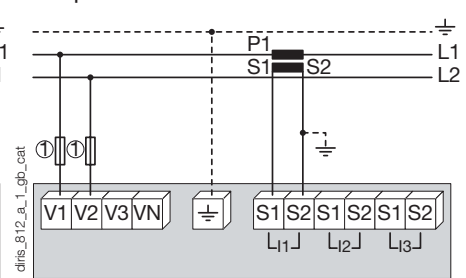

1. Fuses 0.5 A gG / 0.5 A class CC.

Low voltage unbalanced network

3/4 wires with 3 CTs

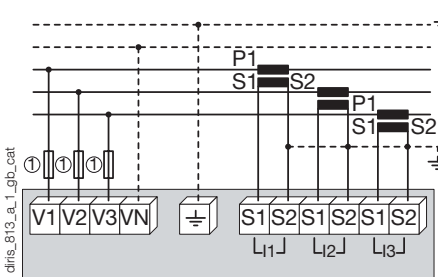

1. Fuses 0.5 A gG / 0.5 A class CC.

3 wires with 2 CTs

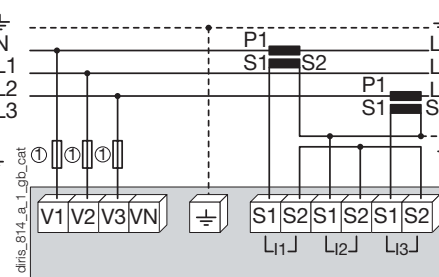

Use of 2 CTs reduces by 0.5% the accuracy of the phases, the current of which is worked out by vector calculation.

1. Fuses 0.5 A gG / 0.5 A class CC.

3 wires with 2 CTs

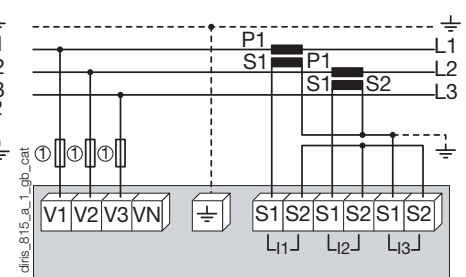

Use of 2 CTs reduces by 0.5% the accuracy of the phases, the current of which is worked out by vector calculation.

1. Fuses 0.5 A gG / 0.5 A class CC.

Additional information

Communication via RS485 link

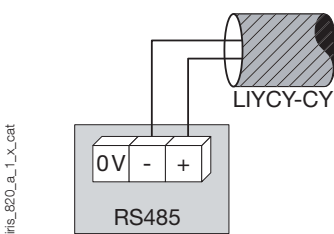

diris_b20_a_1_x_cat

AC auxiliary power supply

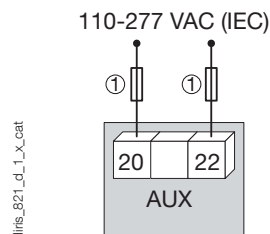

diris_b21_d_1_x_cat

1. Fuses 0.5 A gG / 0.5 A class CC.

Terminals

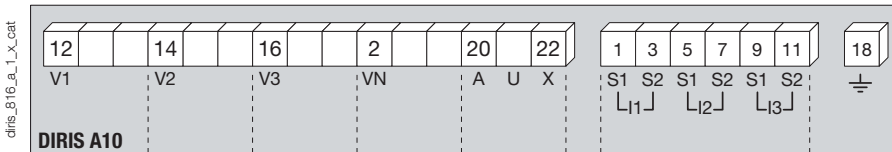

AUX: auxiliary power supply U_s .
V1, V2, V3 & VN: voltage inputs.

S1 - S2: current inputs.

Communication terminals

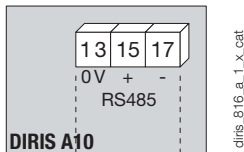

RS485 link.

Pulse or alarm output terminals

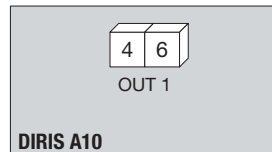

4 - 6: output n°1

Input terminals

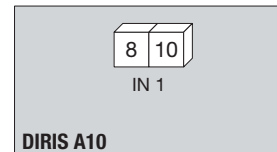

8 - 10: input n°1

References

Basic device	DIRIS A10	
Description	Reference	
DIRIS A10 (available in light grey on request)	4825 0010	
DIRIS A10 with RS485 MODBUS communication (available in light grey on request)	4825 0011	
Description of accessories	To be ordered in multiples of	Reference
Fuse disconnect switches for the protection of voltage inputs (type RM) 3 poles	4	5601 0018
Fuse disconnect switches for the protection of the auxiliary supply (type RM) 1 pole + neutral	6	5601 0017
Fuses type gG 10x38 0.5 A	10	6012 0000
Current transformer range	1	See page 488
Management software for DIRIS		See page 464

Services & Technical Assistance

- Technical site audits and solution specification, commissioning, maintenance, training... Our Services & Technical Assistance experts offer you personalised support to ensure success with all your projects.

